

PM 8060 *vitara*

Haemodynamic Patient Monitor

Instructions for Use
Software version 2.n



Contents

For your safety and that of your patients	4
Intended use	5
Operating concept	7
Preparation for use	13
Monitor functions	19
Parameter Box	49
Messages – Cause – Remedy	73
Care	79
What's what	83
Technical data	89
Abbreviations and symbols	98
Index	101

For Your Safety and that of Your Patients

Strictly follow the Instructions for Use

Any use of the apparatus requires full understanding and strict observation of these instructions.

The apparatus is only to be used for purposes specified here.

Maintenance

The apparatus must be inspected and serviced regularly by trained service personnel at six monthly intervals. Repair and general overhaul of the apparatus may only be carried out by trained service personnel.

We recommend that a service contract be obtained with DrägerService and that all repairs also be carried out by them.

Only authentic Dräger spare parts may be used for maintenance.

Observe chapter "Maintenance Intervals".

Accessories

Do not use accessory parts other than those in the order list.

Not for use in areas of explosion hazard

This apparatus is neither approved nor certified for use in areas where combustible or explosive gas mixtures are likely to occur.

Safe connection with other electrical equipment

Electrical connections to equipment which is not listed in these Instructions for Use should only be made following consultations with the respective manufacturers or an expert.

Liability for proper function or damage

The liability for the proper function of the apparatus is irrevocably transferred to the owner or operator to the extent that the apparatus is serviced or repaired by personnel not employed or authorized by DrägerService or if the apparatus is used in a manner not conforming to its intended use.

Dräger cannot be held responsible for damage caused by non-compliance with the recommendations given above.

The warranty and liability provisions of the terms of sale and delivery of Dräger are likewise not modified by the recommendations given above.

Dräger Medical AG & Co. KGaA

Intended use

Contents

Intended use..... 6

Intended use

Haemodynamic Patient Monitor PM 8060 vitara

When connected to the parameter box, the essential haemodynamic parameters are displayed together with their monitoring features:

- The ECG curve with heart rate and ST segment analysis.
- Two channels for invasively measured blood pressure (iBP), with the pressure values for systolic, diastolic and mean pressure and the pressure curve.
- The measured values for the non-invasively measured blood pressure (NiBP) with the pressure values for systolic, diastolic and mean pressure.
- Two channels for body temperature.
- The functional O₂ saturation (SpO₂) with the pulse rate.
- The plethysmogram.
- The respirogram.
- When connected to an anaesthetic workstation, data from an airway monitor can also be displayed, but in this case **airway alarms are not transferred to the PM 8060 vitara.**

Precautions for use

Fire risk. Use only non-flammable anaesthetic agents conforming to EN 740.

Any add-on electrical equipment must be earthed by means of an equipotential bonding conductor connected to the base unit.

Electromagnetic fields that exceed the value specified in EN60601-1-2 may impair the operation of the apparatus (for example during nuclear spin tomography - MRT, NMR and NMI).

Do not use mobile phones within a distance of 10 metres from the machine.

Mobile phones can cause interference to electrical and electronic medical appliances, thereby putting patients at risk.*

Use the workstation under the supervision of qualified medical personnel, so that assistance can be provided immediately in the event of any malfunction!

* Dräger medical appliances comply with the interference immunity requirements of the specific standards for the products or EN 60601-1-2 (IEC 601-1-2). However, depending on the design of the mobile phone and situation of use, field strengths may occur in the immediate environment of a mobile phone that exceed the values of the standards quoted and therefore cause interference.

Operating concept

Contents

User interface	8
Keys with dedicated function.....	8
Keys with variable function.....	8
Rotary control.....	9
Indicator lamps.....	10
Structure of the screen display.....	10
Menu structure.....	10
Screen saver.....	11
Colour concept.....	11
The various screen displays.....	11

User interface

Keys with dedicated function (Hardkeys)

The right-hand side is reserved for operating elements, the left-hand side for displays.



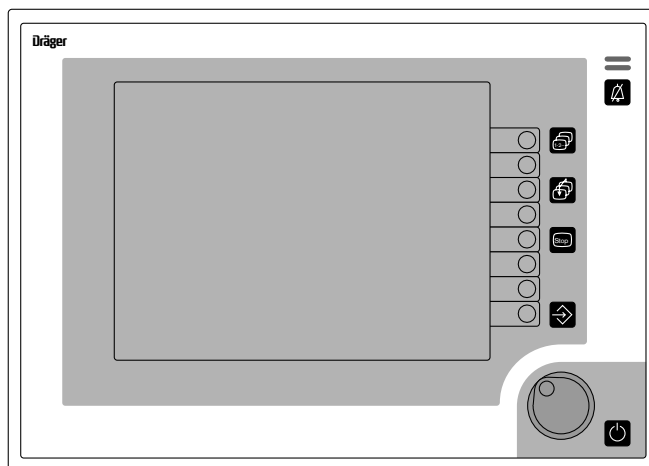

-  This key is used to deactivate the alarm tone for two minutes. The alarm is reactivated by pressing the key again. The yellow LED in the key lights up while alarms are suspended.

Any new messages are signalled once by the appropriate tone sequence.

-  This key switches the monitor from standby to measuring mode and vice versa.



The dark area contains four keys that act directly on the screen contents:

-  This key is used to select the desired screen (standard screen, trend screen and list screen).
-  This key is always used to call up the last standard screen used.
-  This key is used to »freeze« the haemodynamic curves on the screen so that they can be viewed in more detail.
-  This key is used to generate a manual entry in the list screen.

Keys with variable function (Softkeys)

An unlabelled membrane keypad is positioned next to the right-hand edge of the screen.

The function of each of these keys at any one time is software-driven and is displayed in the corresponding position on the screen.

The screen only displays the keys that can be activated at that moment.

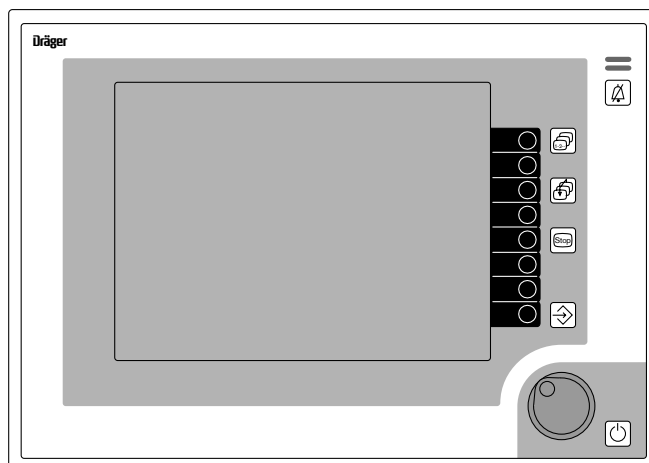

Rotary control

A single "turn-and-push" control is used to select and confirm settings.

Turn to select:

Turning the rotary control moves a cursor frame across the screen or changes a numeric value.

Press to set:

When the rotary control is pressed, the value selected by turning the control is accepted as the valid parameter, or a process is started or stopped.



Example: To adjust the volume of the audible alarm

- 1 Call up the configuration menu from standby mode by pressing the »**config**« softkey.

A menu of default settings is displayed.

- Select = turn the rotary control.
Move the cursor frame to the »**acoustic**« field.
- Confirm = press the rotary control.

- 2 The selected option »**acoustic**« is highlighted in inverse video (dark type on light background – see colour concept).

The cursor frame is positioned over the arrow symbol (↔) in the open »**acoustic**« field.

- 3 This menu is used to:

- set the volume of the alarm and of the pulse tone,
- select between a plain pulse tone and a pulse tone of variable frequency modulated by the degree of oxygen saturation (SpO₂).
- select the tone system (Dräger or ISO standard).

- Turn the rotary control = move the cursor frame into the »**alarm sound**« field.
- Confirm = press the rotary control.

The confirmed selection »**alarm sound**« is highlighted in inverse video (dark on light). The tone is played back at the selected volume.

The dashed selection window now contains volume levels from »1« (soft) to »9« (loud).

The original value (here: »5«) is set against an orange background.

- To set a new value = turn the rotary control.
Move the cursor to the desired volume. The tone is played back at the selected volume.
- Confirm = press the rotary control.
The new value is displayed against an orange background. The cursor-frame returns to the arrow symbol (↔).
- Press the rotary control again (if necessary several times). The cursor moves back one menu level at a time, in each case to the arrow symbol (↔), until you exit the configuration menu.

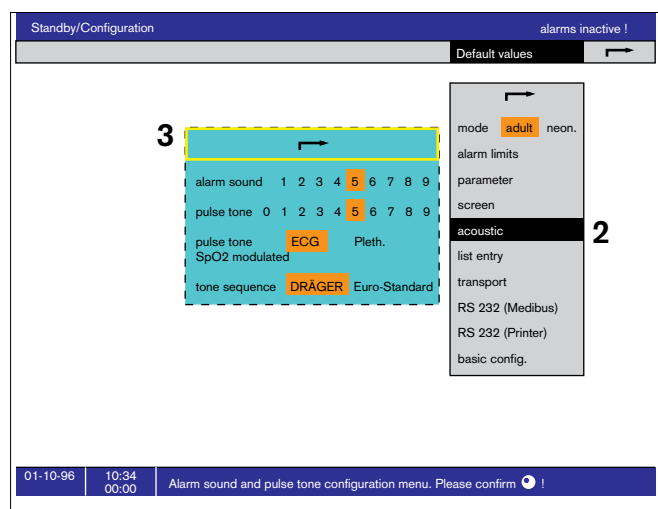
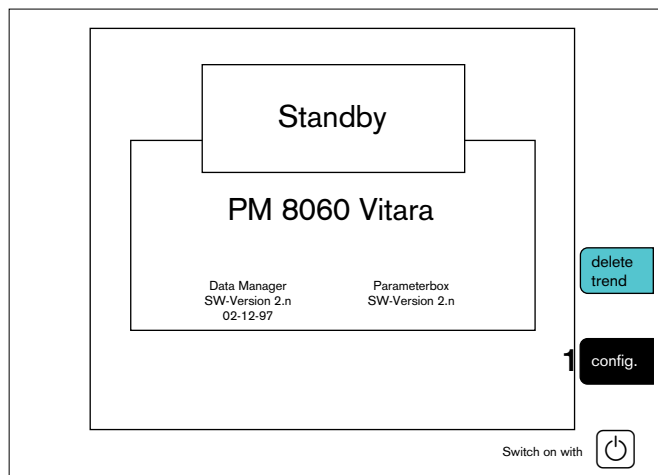

011230094

011230094

011230094

Indicator lamps

Two bar-shaped indicator lamps are located above the  key: these lamps continue to indicate the alarm states even when the acoustic alarm is suspended:

Red (upper) lamp, flashing: **Warning !!!**
 Yellow (lower) lamp, flashing: **Caution !!**
 Yellow lamp, constant: **Advisory !**

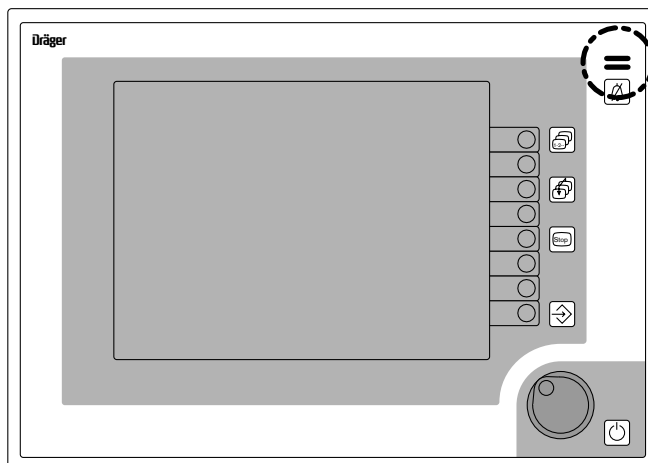

Structure of the screen display

The screen is made up of grids in which the individual traces and blocks of measured values («modules») can be defined as required.

The fields for date/time, equipment status, warning, caution or advisory messages, the screen keys (softkeys) and the user advisory field are always located in the same place in all screens.

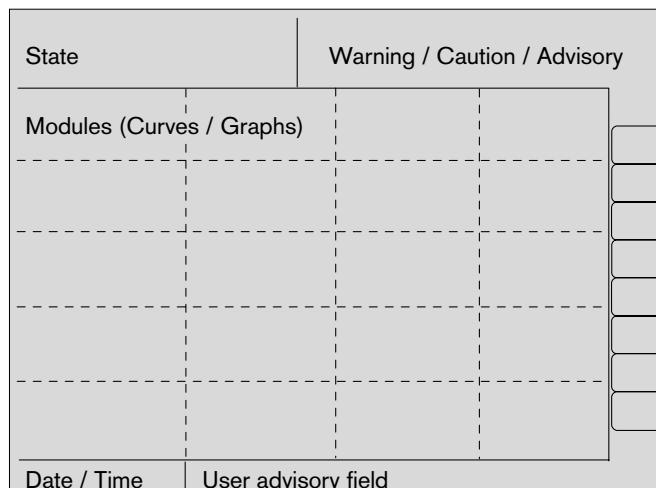

Menu structure

The hierarchy and sequence of menu levels is made clear by their staggered arrangement across the screen. The active menu is always green with a yellow cursor. Previous menu levels are grey with a black cursor.

The fields shown against an orange background indicate the current configuration. The procedure for opening and closing menus is always the same.

It is always possible to return directly to the standard screen by pressing the  key.

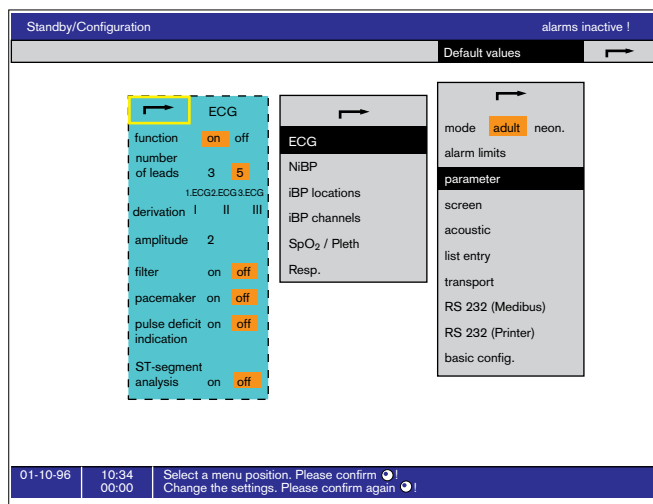

Screen saver

If none of the controls or keys on the Monitor is operated for about 5 minutes while in »Standby« mode, the screen switches to a screen saver program to prevent screen burn-in. The yellow LED in the Standby key lights up, and a Dräger logo (**Dräger**) appears at different positions on the screen.

The screen display is restored immediately any user operation is detected.

Colour concept

Certain colours are used recurrently with the same standard meaning when operating the device:

Screen element:	Display colour:
Active menu level	Cyan
Non-active menu level	Grey
Cursor	Yellow frame
Selected menu item	Inverse (white on black)
Selected alternative.....	Orange background

Alarm messages are displayed in clearly distinct fields according to the urgency of the message:

1 Warning	Symbol	»!!!«	Text on red field
2 Caution	Symbol	»!!«	Text on yellow field
3 Advisory	Symbol	»!«	Text on white field

The colours of the individual measurement parameters and displays and the choice of bright or dark background can be freely configured by the user (see page 30).

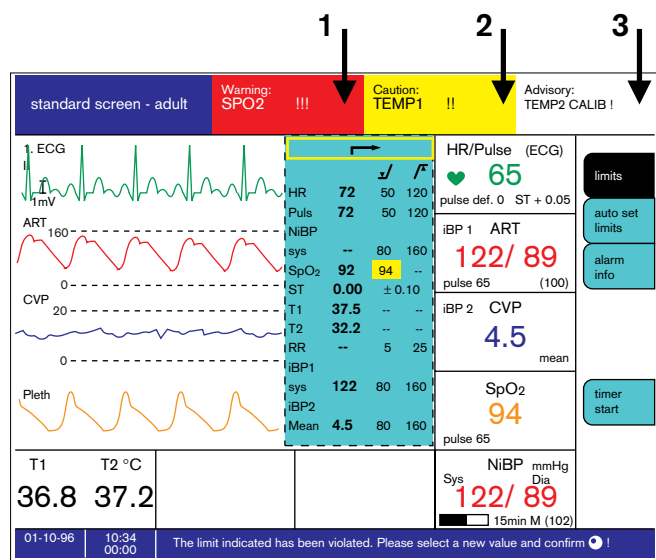

The various screen displays

4 The other screen pages are called up by pressing .

A selection menu is then displayed for the following alternative screen displays:

- Standard screen 1,
- Standard screen 2,
- List screen and
- Trend screen.

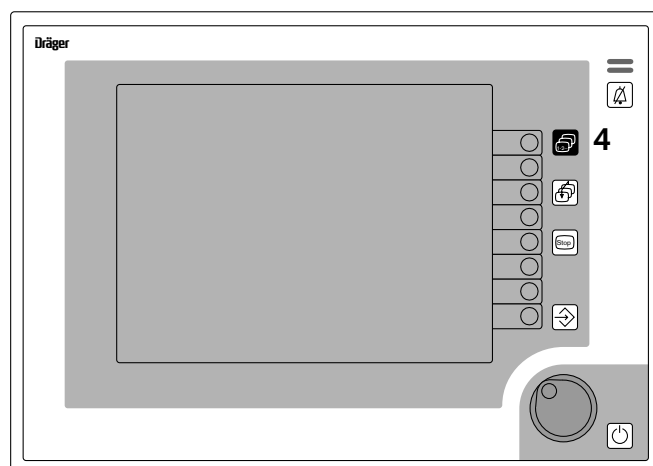

Standard screen (1 or 2)

containing the configured graph and measured value fields.

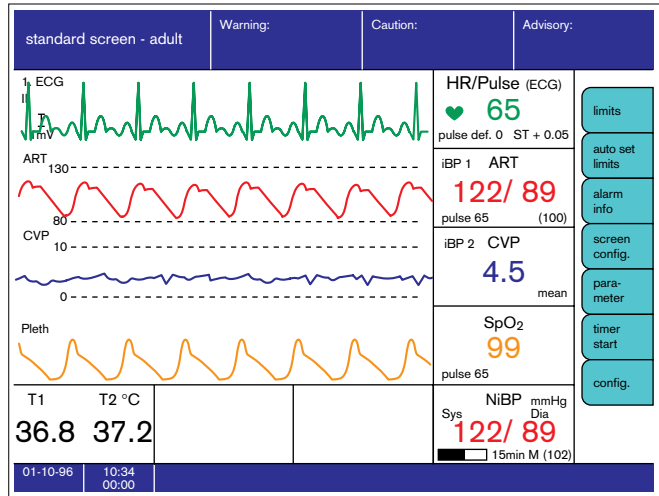

List screen

containing all measured values and alarms; thereby making it easier to complete the anaesthesia record. This list can also be printed out to a connected printer (optional).

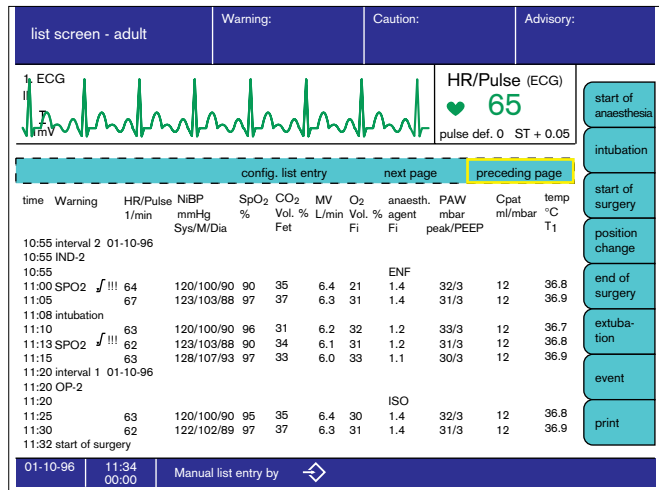

Trend screen

for displaying the trend curves of the measured values over time.

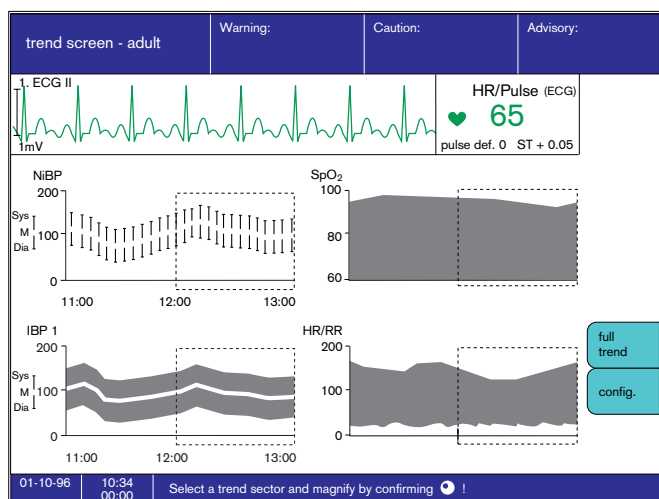

Preparation for use

Contents

Connecting the System	14
Connecting the power supply	14
Connecting external devices	14
Switching the monitor on and off	18

Connecting the System

Connecting the power supply:

When used in combination with an anaesthetic machine »Julian«:

- 1 Connect the CAN port (marked »CAN 1«) at the back of the screen to the CAN port on the back of the anaesthetic unit (port marked »CAN 1«).

When used as stand-alone Monitor or with Dräger-»Cato«:

- 1 Connect the CAN port (marked »CAN 1«) at the back of the screen to the Vitara power adapter.
- Plug the power cord from the Vitara power adapter into a 230 V mains socket. With anaesthetic units, the power is supplied via a socket that is switched on and off by the system master switch.
- 2 »CAN 2« is designed for add-on units.
- 3 For intracranial and intracardial operations, equipotential bonding must be ensured by connecting a grounding cable from the ground stud on the back of the screen (marked ∇) to the ground stud in the operating theatre!

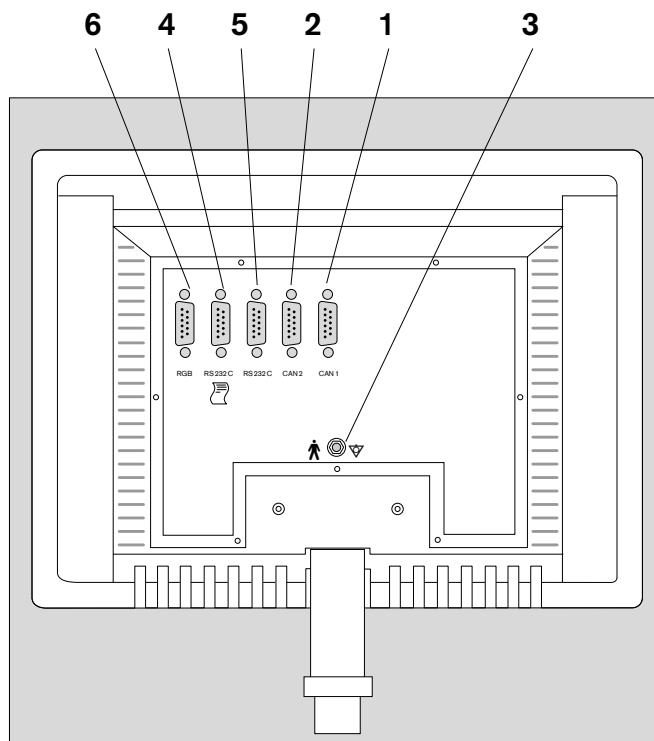

Connecting external devices

Interface configuration, see page 34.

Via the RS 232 printer interface:

- 4 Using a printer data cable (serial interface or converter for the parallel interface)
- Secure the device connectors by tightening the screws provided!

Via the Dräger RS 232 MEDIBUS interface:

- 5 Using a data cable for connecting a Medibus device (e.g. PM 8050 Monitor, »Julian« Anaesthetic Workstation or a PC).
- Secure the device connectors by tightening the screws provided!

Via the RGB interface:

- 6 Using the monitor cable to connect an external RGB screen (VGA or SVGA, Multisync.).
- Secure the device connectors by tightening the screws provided!

PM 8060 vitara to »Julian«

- Julian CAN 1/2.....toVitara CAN 1
 - Julian CAN 1/2.....toParameter box holder
 - Julian COMtoVitara RS 232 C
 - PrintertoVitara RS 232 C 
- The authorised cable types are listed in the Accessories list.

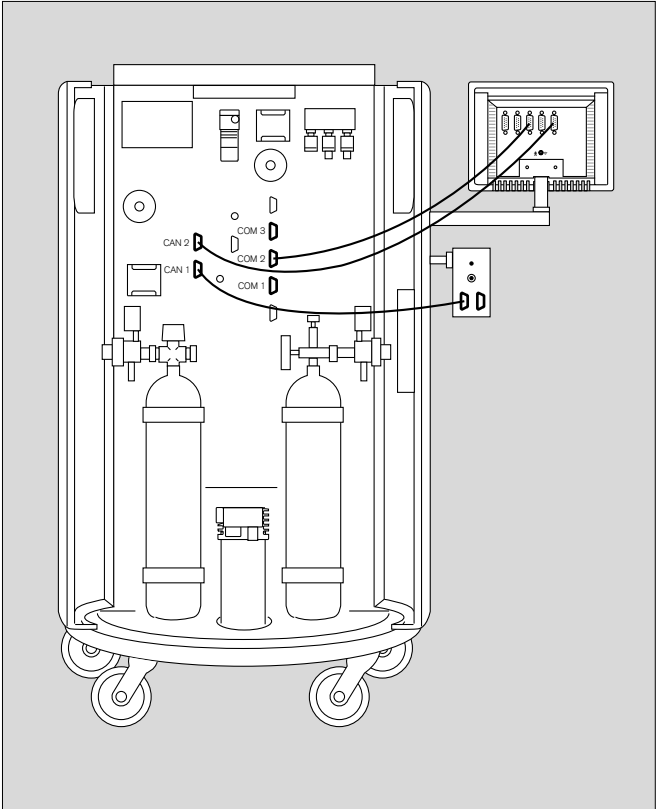

01929094

PM 8060-vitara with external power adapter as stand-alone monitor or connected to »Cato«:

- Power adapter CAN1/2.....toVitara CAN 1
 - Power adapter CAN1/2.....toParameter box holder
 - Airway monitortoVitara RS 232 C
 - PrintertoVitara RS 232 C 
- The authorised cable types are listed in the Accessories list.

Never connect a CAN connector to an RS 232 C connector: especially in PCs, a wrong connection of this kind can damage the RS 232 C interface.

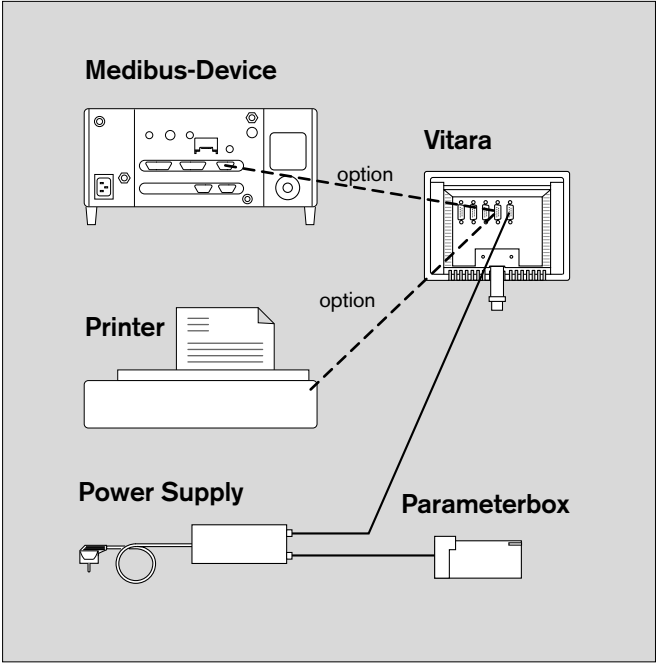

01729094

Fitting the PM 8060 vitara to the swivel arm of a Dräger Anaesthetic Unit

- Push the arm on to the rail and fix with two screws.
- 1 The arm's resistance to movement can be adjusted at the hinge (Allen screw - A/F 6 mm).
 - 2 Screw the PM 8060 vitara securely to the arm. If necessary, fix with thread-locking compound (Allen screw - A/F 12 mm).

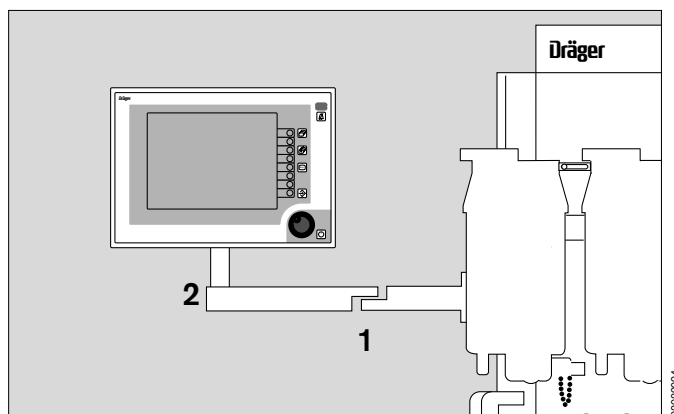

Fitting the PM 8060 vitara to the swivel arm of a standard rail

- Check the load-bearing capacity of the rail. The weight of the PM 8060 vitara complete with parameter box is approx. 5 kg.
- 3 Screw the PM 8060 vitara securely to the arm. If necessary, fix with thread-locking compound (Allen screw - A/F 12 mm).
 - 4 Place the arm on the rail and fix with the rail clamp.
- Also fix the power adapter to the rail.

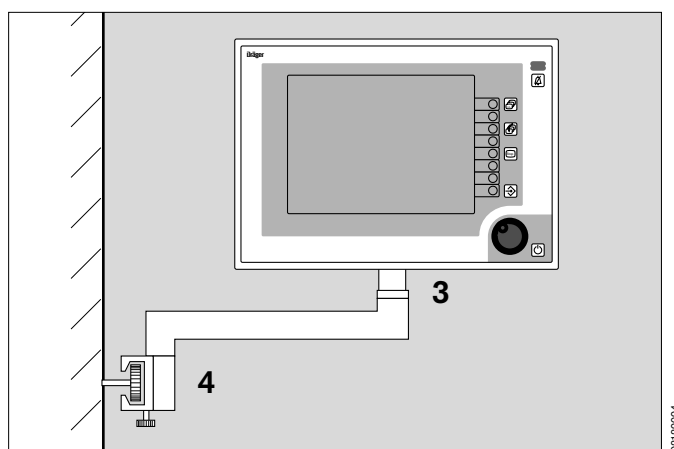

PM 8060 vitara stand-alone on pedestal

- 5 Screw the PM 8060 vitara securely to the pedestal (Allen screw - A/F 12 mm) and stand on a suitably strong, horizontal and non-slip surface.

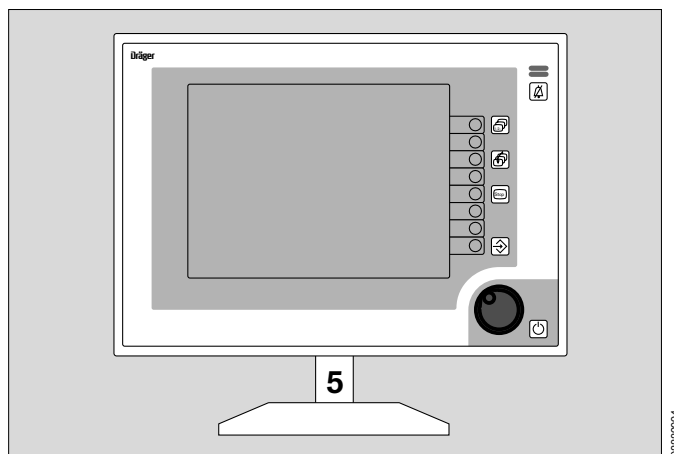

Turning and tilting

You can adjust the viewing angle of the PM 8060 vitara and adapt it to the ergonomic requirements of your workplace.

- 6 The tilt resistance can be adjusted with two cross-slotted screws.
- 7 The swivel resistance can be adjusted by the screw on the inside of the fixing column (Allen screw - A/F 5 mm).

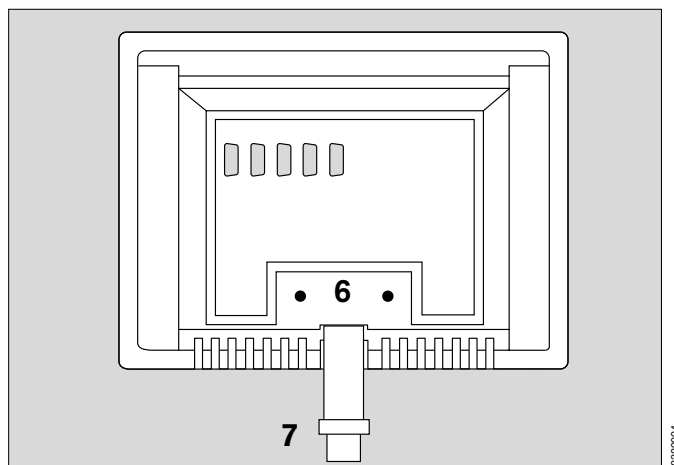

Fitting the parameter box

The parameter box can be operated either in its blue holder or in the slot-in housing.

The slot-in housing can be installed in an anaesthetic system (e.g. Julian or Cato) by Dräger Service.

The blue holder can be attached by the user to a standard rail (10 x 25 millimetres) in the work area.

With the blue holder, the parameter box can be pivoted up and down. In the slot-in housing, its position is fixed.

In both cases, the synchronisation output for an external defibrillator is accessible from the back of the machine!

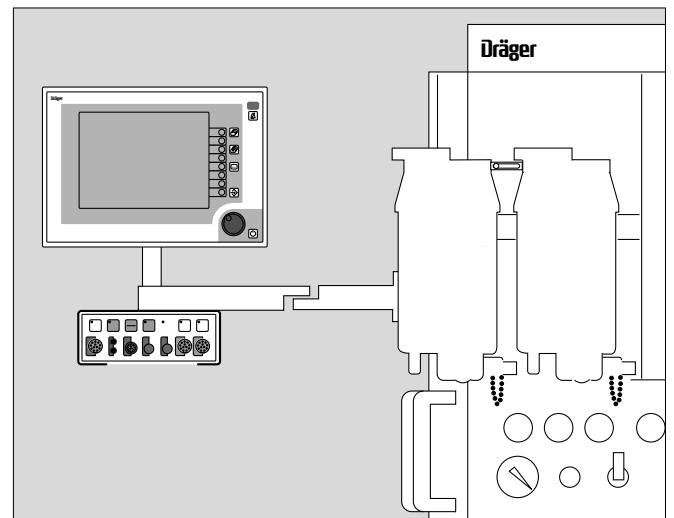

Holder for operating table:

Alternatively, the "Op. Table" parameter box holder can be used. This holder is especially suitable for fixing close to the patient. It can remain on the operating table or bed when transporting the patient. The parameter box is connected to the PM 8060 vitara by means of the quick-release cable and is mounted securely in the housing.

This system is not compatible with the holders with clip-in mechanism.

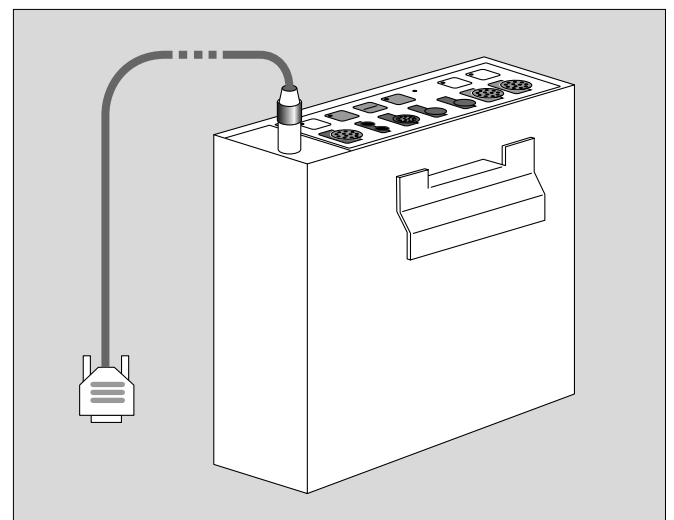

Slot-in housing:

- Push the parameter box as far as it will go into the slot-in housing. The parameter box must lock into position, thereby connecting up its electrical connections.

To remove the parameter box, pull the blue handle on the parameter box to release the locking mechanism. The parameter box can then be pulled out of the slot-in housing.

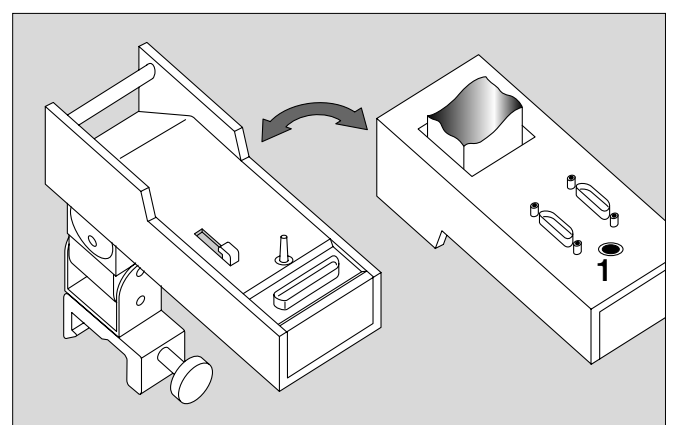

Blue holder:

- Fix the blue holder in a suitable position.
- Connect the holder to the power supply (i.e. the power adapter in the stand-alone version or the back of the Julian or Physio Flex) using the cable supplied.
- Hang the parameter box onto the holder from above. The plug connector must engage.
- To remove the parameter box, pull the blue handle of the box. This releases the box so that it can be removed from the blue holder.

1 Defibrillator connection.

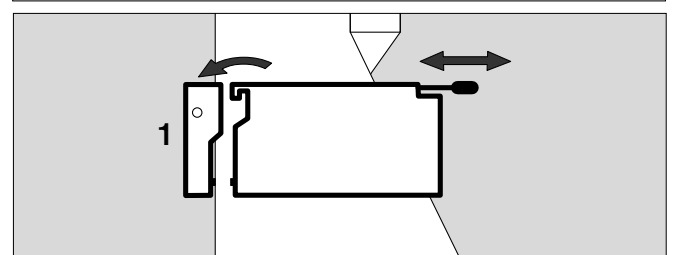

Preparation for use

Switching the machine on and off

Tilting the parameter box

After overcoming an initial holding resistance, the parameter box can be easily tilted to an ergonomically comfortable angle.

The holding resistance can be adjusted at the hinge. The adjusting screws are covered by white caps (Allen screw - A/F 6 mm).

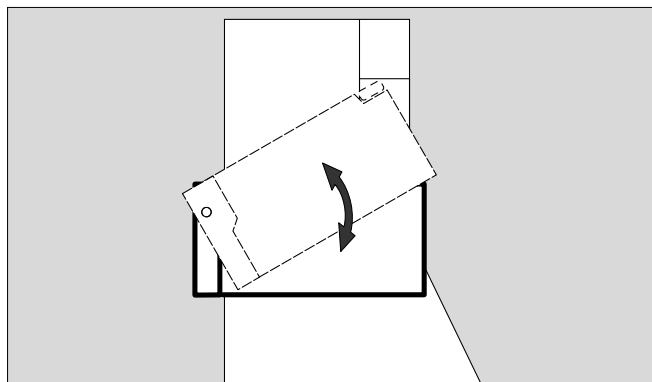

02726094

Switching the monitor on and off

When used in combination with an anaesthetic system (e.g. Julian):

- The PM 8060 vitara is switched on and off by the master switch of the anaesthetic system.

When used as stand-alone monitor:

- The power adapter has its own master switch.

After switching on

The Monitor runs through its start-up and self-test routines:

- The internal program memories are tested. All LEDs and display elements light up for about 2 seconds.
The LED in the Standby key  remains lit.
- An alarm tone is generated.
- The screen is activated and displays a clock symbol (⌚ = "please wait", duration of delay for the self-test).
- The keys are not yet activated.

Shortly after this initial period, the Monitor automatically enters »Standby« mode.



02726094

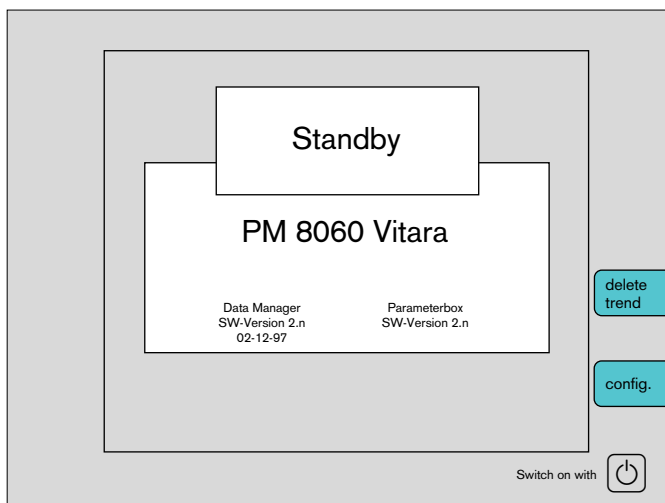

02726094

Screen Functions

Contents

Configuring the screen	20
Mode.....	22
Alarm limits	23
Parameters.....	23
Configuring the standard screen with modules	27
Configuring the screen colours	30
Acoustic	31
List entry	32
Transport function.....	32
RS 232 MEDIBUS.....	34
RS 232 Printer	34
Basic configuration.....	35
Screen functions during operation	35
Starting up the screen	35
Standard screen	37
List screen	37
Trend screen with zoom function	39
Alarm limits	40
Autosetting the patient alarms	41
Alarm information	42
Configuring the screen structure in operation	42
Parameters	42
Timer	43
Configuration	43
Alarm concept	45
Alarm priority	45

Configuring the screen

Basic configuration in standby mode:

The basic configuration is protected by a password and can only be modified in standby mode. This configuration is reactivated whenever the Monitor is started (i.e. switched on or operated from standby mode). It can also be reactivated by selecting »**Call standard**« during operation.

Temporary configuration during operation:

The screen settings entered during operation remain active until the screen is next switched off.

The alarm limits set during operation only remain active until the screen is next switched to standby mode.

In both cases, after switching off, the password-protected basic configuration is reactivated. This configuration can also be activated at any time by selecting »**Call standard**«.

If the screen has been blacked out by the screen-saver function, it will be reactivated as soon as any activity is detected on the machine!

The »Standby« screen contains two screen keys (softkeys) for calling up menus:

1 Delete trend; e.g. for a new patient:

The »Standby« screen contains two screen keys (softkeys) for calling up menus for

- deleting the trend and list memory
- configuring the screen.

The trend memory and list are both cleared at the same time. If a parameter box is connected, the data in the parameter box will also be deleted!

- Press the »**delete trend**« softkey.
The system asks you again to confirm you are sure you want to delete the trend.
- Press the »**delete**« key to confirm.
If you press »**do not delete**«, the original screen will be restored unchanged.

2 Calling up the standby configuration menu

- Press the »**config**« softkey to obtain the configuration menu.

Configurations set in »standby« mode remain active whenever the machine is switched on again.

By contrast, configurations entered during operation are only valid until the machine is next switched off (alarm limits remain valid until the next »Standby«).

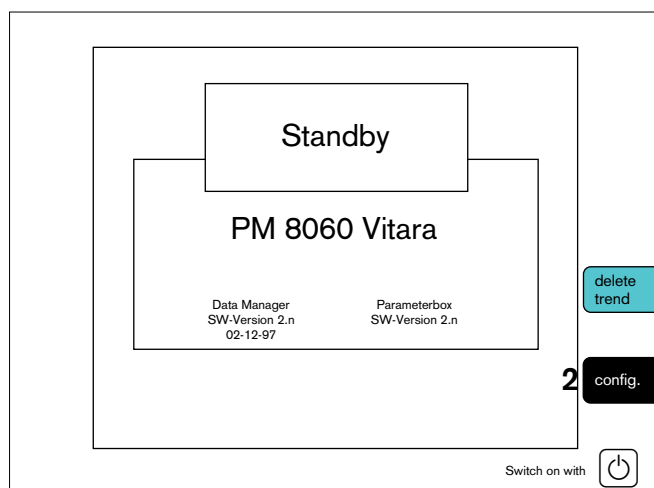
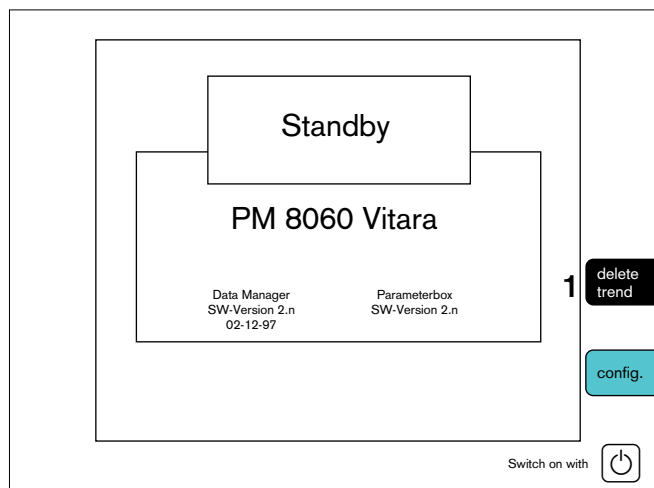

The screen illustrated opposite is displayed:

- Turn the rotary control until the cursor frame is positioned over »default values«.
- Press the rotary control.

Changing default values

The password-protected default settings are activated whenever the machine is switched on. Before these settings can be changed, the correct password must be entered:

Entering the password:

- The password consists of four digits. The numbers are selected one-by-one from the number bar by turning the rotary control and pressing to confirm in each case.

After you have confirmed the fourth correct digit, you will be allowed to access the "default values" pull-down menu.

The menu for configuring the default values and settings is displayed:

mode	Switches over between adult and neonatal mode (toggle).
alarm limits	Configure the defaults for adult or neonatal alarm limits.
parameters	Default settings for the haemodynamic parameters.
screen	Configures the various screens.
acoustic	Sets the volume and type of tone sequence.
transport	Defines the data exchange between parameter box and system monitor during patient transfer.
RS 232 (MEDIBUS)	Sets the interface parameters
RS 232 (Printer)	Configures the printer interface or the second Medibus interface.
basic config.	Date time and language selection and location of the machine.

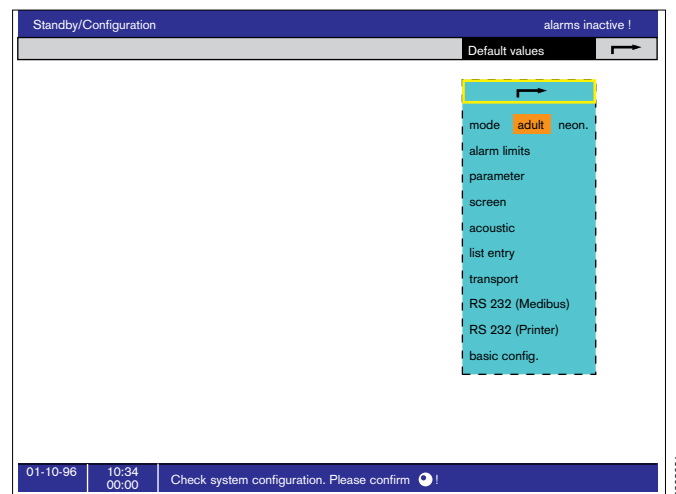
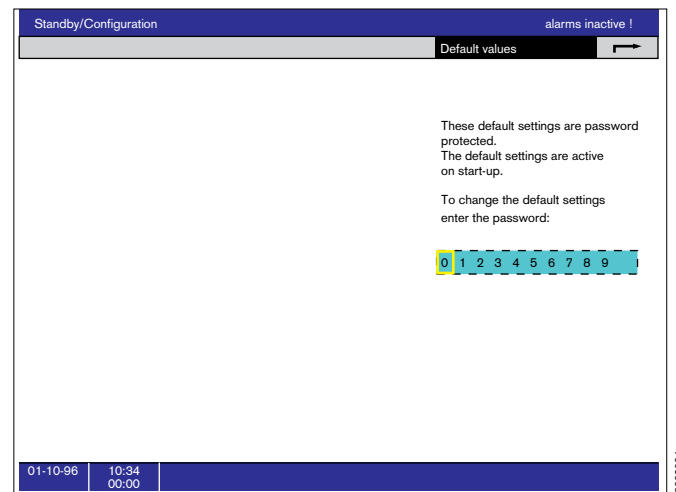
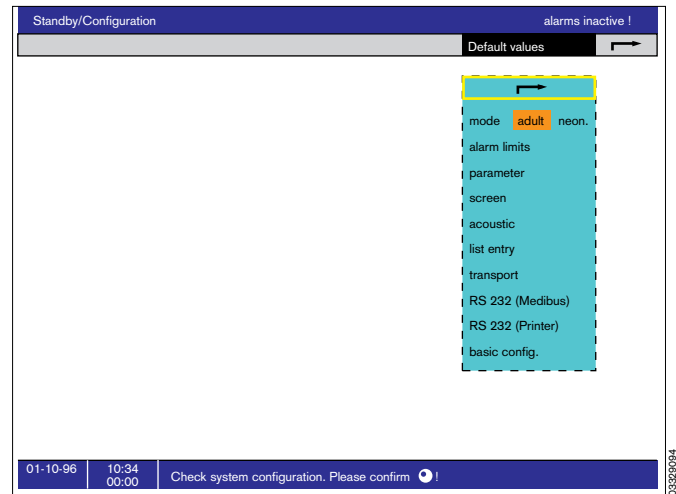

03220094

03220094

03220094

These settings are always called up and changed by the same procedure:

- **Turn the rotary control**
to activate the option marked by the cursor frame.
- **Press the rotary control**
to make a selection inside the dashed border.
- **Fields with orange background**
represent the current settings. The illustrations that follow always show the factory-set defaults.
- **Fields with black or white background**
show the previous menu steps used to reach the currently selected field.
- **The arrow (↩)**
refers back to the previous menu level.

Mode

For the following features, the PM 8060 vitara has separate data sets in adult and neonatal modes

- alarm limits
- curve speed,

These data sets can be separately configured and stored by the user:

The user can switch between these data sets by selecting:

adult = adult mode

neon. = neonatal mode.

Various settings for NiBP measurement are also switched over at the same time.

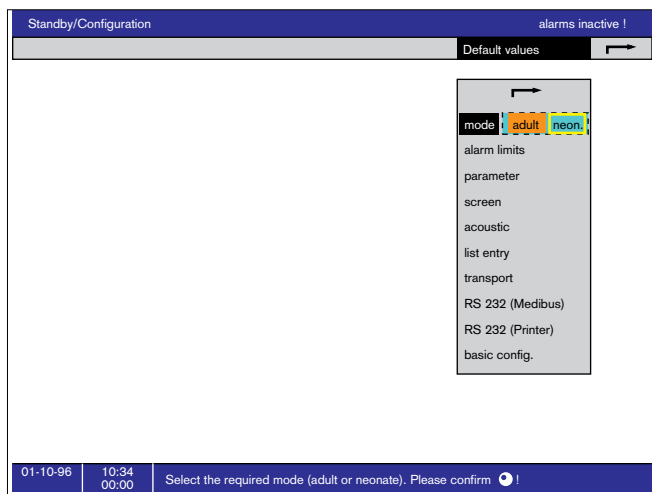

Alarm limits

This menu defines:

- the default alarm limits for the two different operating modes (adults and neonates).

These alarm limits are automatically active after

- switching on the PM 8060 vitara
- leaving »Standby« mode
- selecting »default« under »Alarms«.

If the adult/neonate (adult/neon.) mode is changed later, the alarm limits preset for the relevant mode will remain valid.

From this menu, the familiar procedure of »selecting« (turning the rotary control) and »confirming« (pressing the rotary control) can be used to open the following sub-menus

- **iBP**
- **ECG / SpO₂ / NiBP / Temp / ST / RR**

complete with the corresponding settings for the upper and lower alarm limits.

Two dashes (– –) in the table mean that this alarm limit is inactive and not monitored. It can be activated by turning the rotary control beyond the maximum or minimum value possible and confirming it.

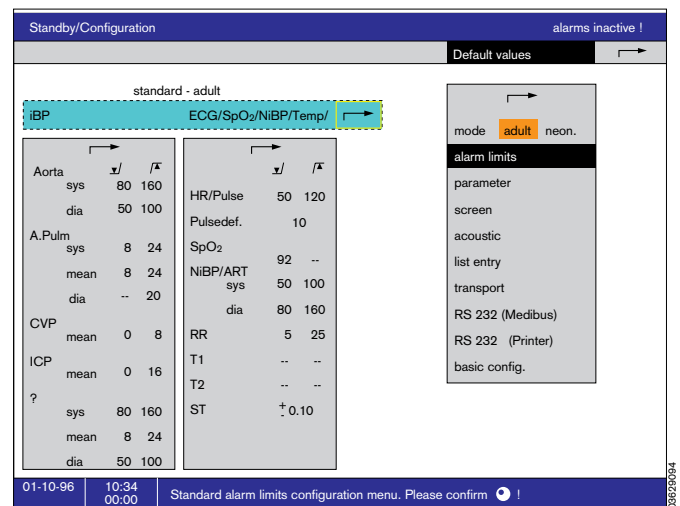
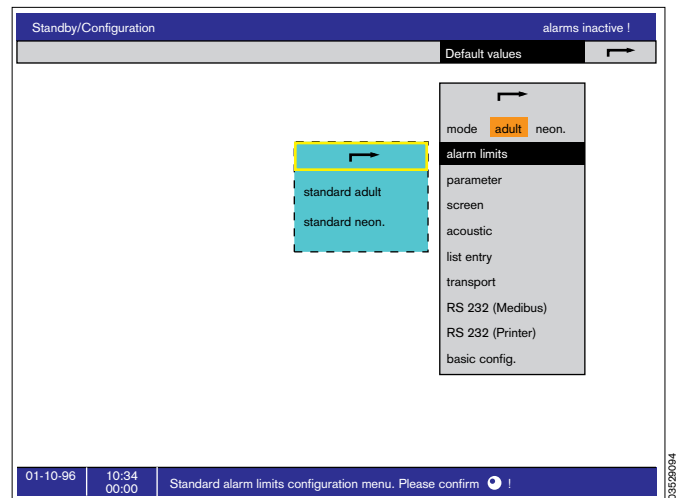

Parameters

The settings for the following parameters are defined in this menu:

- ECG** Electrocardiogram
- NiBP** Non-invasive blood pressure
- iBP measuring site** Preconfiguration for measuring sites
- iBP channels** Preconfiguration for channels
- SpO₂/Pleth** Pulsoximetry/plethysmogram
- Resp** Respiration

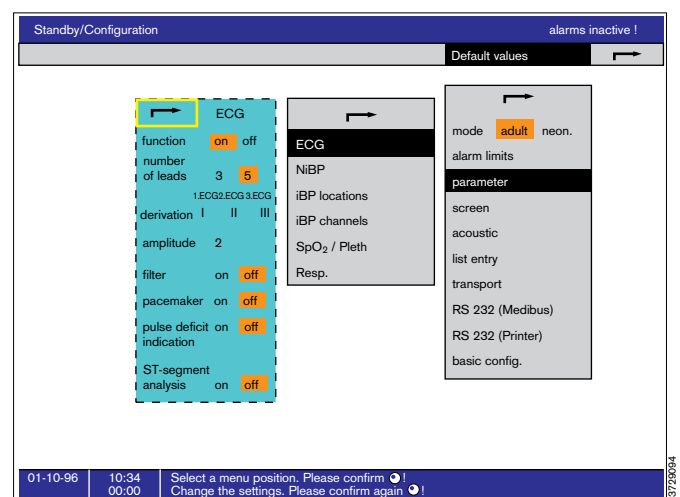

ECG settings

With the parameters:

- measuring function** Switching ECG measurement on or off.
- number of leads** Choice of 3-core or 5-lead cable.
- derivation** Choice of displayed derivation for the 1st, 2nd and 3rd ECG curve.
- amplitude** Measurement sensitivity.
- filter** Switches the filter on or off.
- pacemaker** Switches pacemaker detection on or off (see page 59).
- pulse deficit indication** Switches the indication on or off.
- ST-segment analysis** Switches the function on or off.

If a 3-lead ECG cable is selected, only one ECG can be displayed. The options of a 2nd and 3rd ECG are therefore removed.

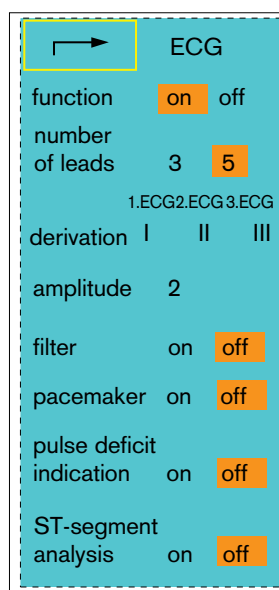

07320095

NiBP settings

With the parameters:

- time interval** Sets the time between measurements.
- active alarms** Selects which criterion is to be monitored (diastolic or systolic).
- initial pressure** Sets the starting pressure for the selected mode (value depends on the selected »mode« - adult / neonate).
- punction pressure** Sets the punction pressure for the selected mode (value depends on the selected »mode« - adult / neonatal).
- units** Sets the measurement unit.
- interlock** Selects whether the interlock function should be totally deactivated or coupled to either SpO2 measurement or iBP measurement (thereby suppressing the relevant alarms and measured values during NiBP measurement).

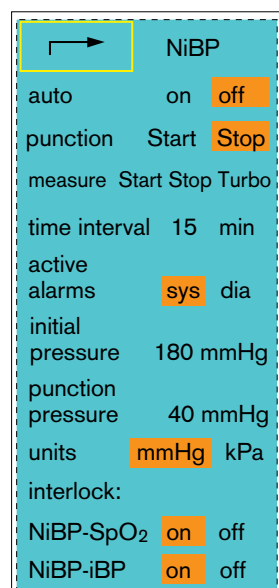

07320095

iBP locations

This function can be used to preset all the measuring sites independently of the measuring channel. The following abbreviations are used:

ART	Arterial
AORTA	Aorta
A. Pulm.	Pulmonary artery
CVP	Central venous pressure
ICP	Intracranial pressure
?	Any other site

The following parameters can be set:

- active alarms** Selects the monitoring criterion. For example, should systolic, diastolic or mean pressure be monitored?
- graph** Selects the curve scale. Fixed values or automatic amplitude adjustment.
- amplitude** Selects the curve scale. Not selectable with automatic amplitude adjustment.
- pulse** Switches pulse rate display on/off.

→			
ART	active alarms	sys	dia
	graph	absol.	morph.
	amplitude	160	
	pulse	on	off
AORTA	active alarms	sys	dia
	graph	absol.	morph.
	amplitude	160	
	pulse	on	off
A. Pulm	active alarms	sys	dia mean
	graph	absol.	morph.
	amplitude	40	
CVP	active alarms	mean	
	graph	absol.	morph.
	amplitude	20	
ICP	active alarms	mean	
	graph	absol.	morph.
	amplitude	20	
?	active alarms	sys	dia mean
	graph	absol.	morph.
	amplitude	160	

03929094

iBP channels

defines the input channels P1 and P2 of the parameter box:

- measurement function** Switches the channel on and off.
- location** Enters the locations of this channel.
- sensitivity** Selects the sensor sensitivity. 42.5 or 50 $\mu\text{V}/\text{V}/\text{mmHg}$.

→			
iBP 1	function	on	off
	location	AORTA	
	sensitivity	42.5	50
iBP 2	function	on	off
	location	CVP	
	sensitivity	42.5	50

03929094

SpO₂/Plethysmogram

With the parameters:

- measuring function** Switches SpO₂ measurement on and off.
- pulse** Switches pulse rate display on and off.
- C-Lock** Switches ECG synchronisation on and off.
- mode** Sets the measurement response speed. (Fast measurements are more susceptible to disturbance).

→		
SpO ₂ / Pleth		
function	on	off
pulse	on	off
C-Lock (ECG synchr.)	on	off
mode	slow	normal
		fast

03929094

Respiration

With the parameters:

function	Switches respiration measurement on and off.
mode	Automatic or manual adjustment of the recorded level
amplitude	Selects the curve size. The minimum size must correspond to the length of the displayed bar.
trigger	Activates/deactivates the superimposed display of respiration recording pulses on the respiration curve (to check that respiration recording is correctly in progress).
apnea	Time interval in seconds after which an apnoea alarm is triggered in the absence of respiration measurement signal.

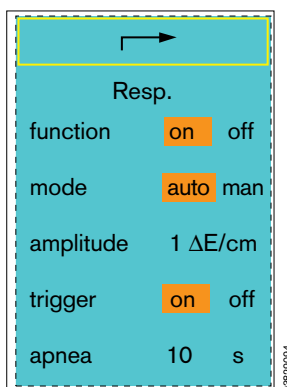

Configuring the standard screen with modules

This menu is used to configure the screen. The machine stores the configuration and screen-related settings:

- standard screen
- colour
- curve speed
- general settings

When selected, the standard screen is immediately available with the desired setting.

The screen is made up of »modules«, which can be selected from the menu by means of the rotary control.

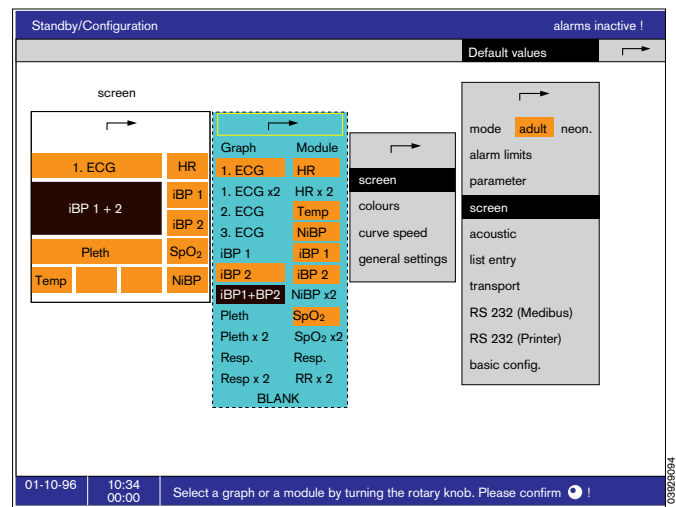

Configuring standard screen

Example: The screen structure is shown schematically on the left-hand side of the screen. Alongside it, there is a table of graphical modules and numerical modules for selection.

Modules which are already selected are highlighted against an orange background, and their designations are contained in the module blocks.

- Move the cursor frame through the module table to the module you want to change (in this example: iBP 1 and iBP 2) by turning the rotary control.
- Press the rotary control to confirm.

The module block in the table goes grey and appears in the schematic layout on the left, bordered by a cursor.

- The block can now be moved to the desired position in the schematic layout by turning the rotary control.
- When the rotary control is pressed to confirm, the desired module is set in its current position on the screen.
- To delete a module, the relevant position on the screen must be overwritten with a blank module.

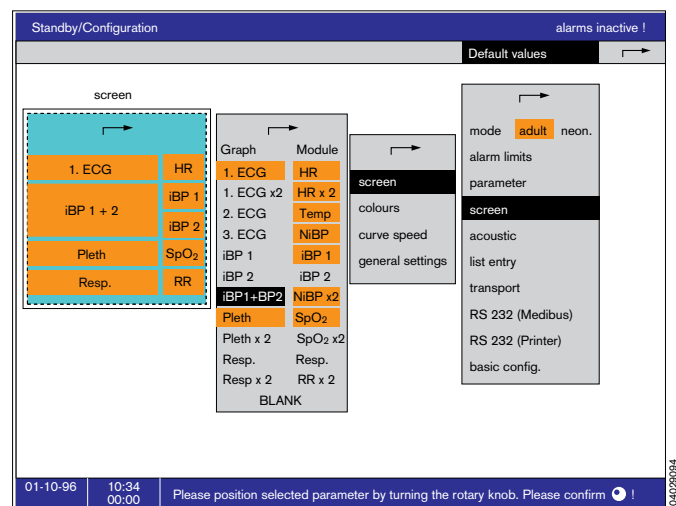

Examples of the selectable graph modules:

ECG graph ECG real-time graph. The derivation, amplitude and curve speed are freely selectable in discrete increments.

This graph can also be displayed in a double-height module.

iBP curves:

ART Displays the iBP curve for the arterial blood pressure in a separate graph of single module height.

CVP Displays the iBP curve for the central venous blood pressure in a separate graph of single module height.

iBP 1 + iBP 2 Displays two iBP curves (ART and CVP) in a single graph with double the module height.

Plethysmogram curve

Real-time curve of the plethysmogram measured by the SpO₂ sensor.

This curve can also be displayed in a double-height module.

Respiration curve

Real-time curve of the respiration characteristic.

This curve can also be displayed in a double-height module.

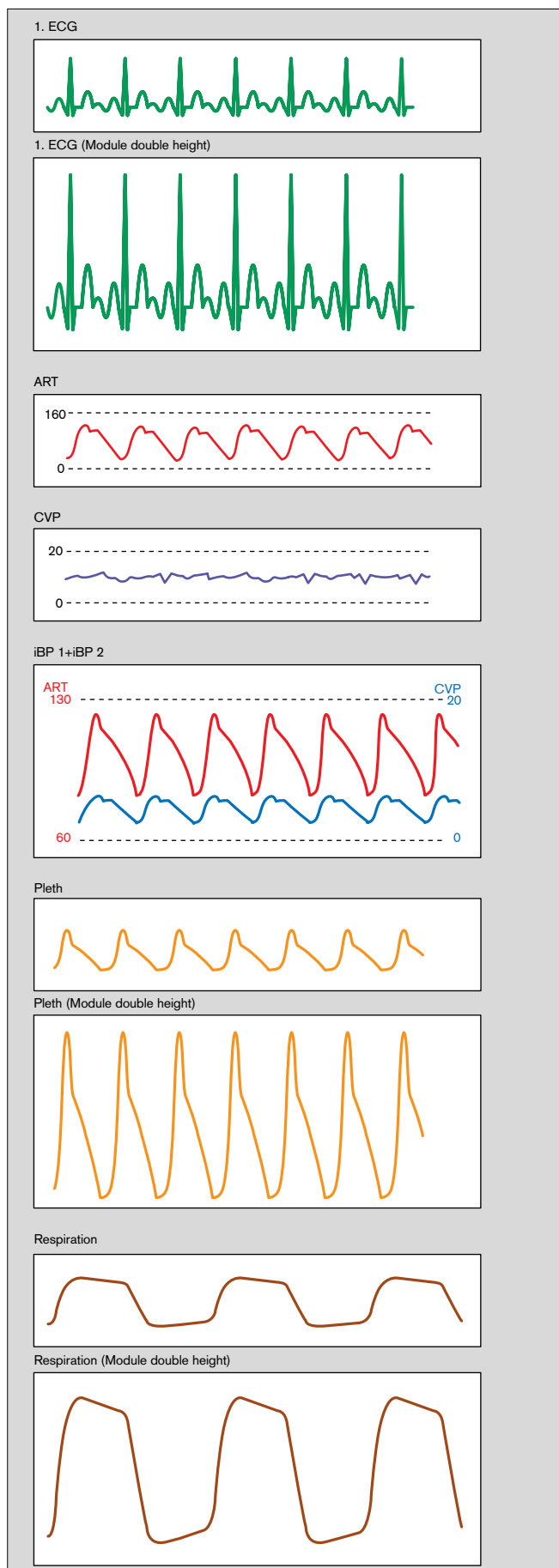

Examples of the selectable numerical modules:

Temp 1/2 Shows the temperature values of the selected channel (1 or 2).

NiBP Shows the non-invasive blood pressure, the mean pressure and the time remaining until the next measurement. During measurement, the bar displays the current cuff pressure.

SpO₂ Shows the functional O₂ saturation of the blood and the pulse rate.

iBP 1/2 Shows the blood pressure of the selected channel (1 or 2).
The systolic/diastolic and mean invasively measured blood pressure values are displayed, together with the pulse rate.
For CVP and ICP, the mean pressure only is displayed.

Heart rate Shows the heart rate derived from the 1st ECG. Additionally, the pulse deficit obtained from the difference between the heart rate and the pulse rate measured during SpO₂ measurement can be displayed, as well as the ST segment size of the 1st ECG.

Respiration Shows the respiration rate derived from the first lead of the 1st ECG.

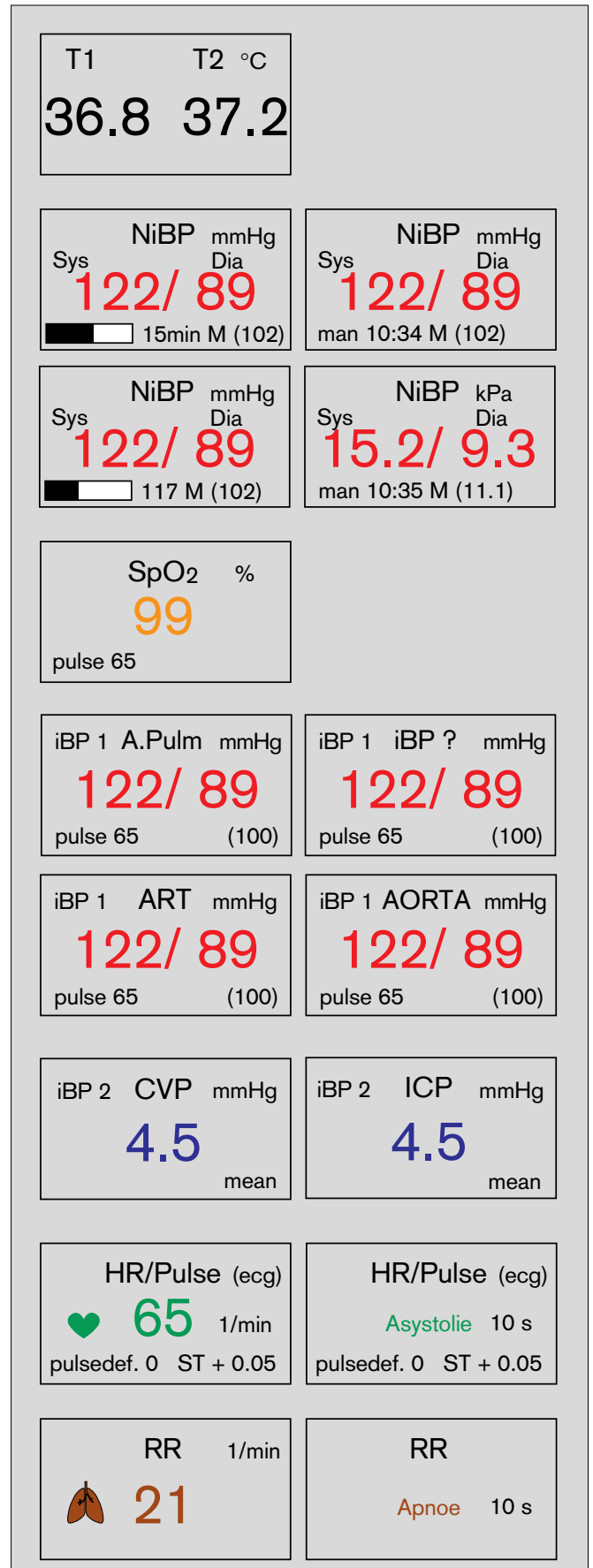

04220604

Configuring the colour settings

Colour settings always apply to all the features associated with a parameter. The numerical modules, if configured for colour, are the same colour as their corresponding curves.

- Select and confirm the desired parameter.
- Change the colour by turning the rotary control. The colours are displayed in the sequence shown in the colour bar at the top of the menu.
- Confirm the desired colour.

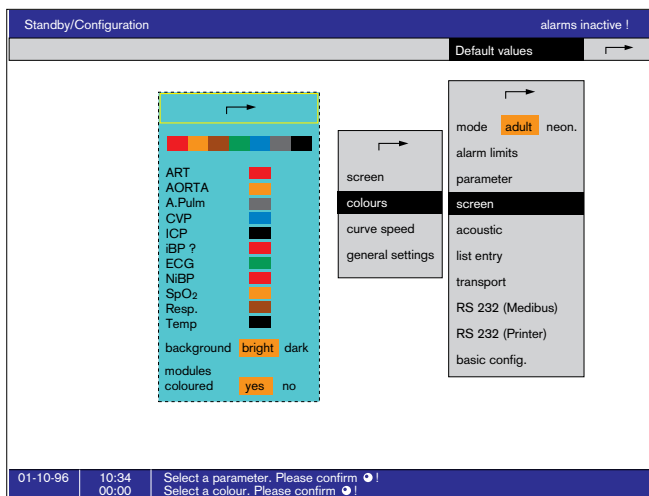

Configuring the background settings

dark Black background, light curves and numbers. Preferably used in a dark environment.

light White background, dark curves and numbers. Preferably used in a bright environment.

colour modules

yes The numerical modules will be the same colour as the corresponding curves.

no The numerical modules are displayed in black-and-white.

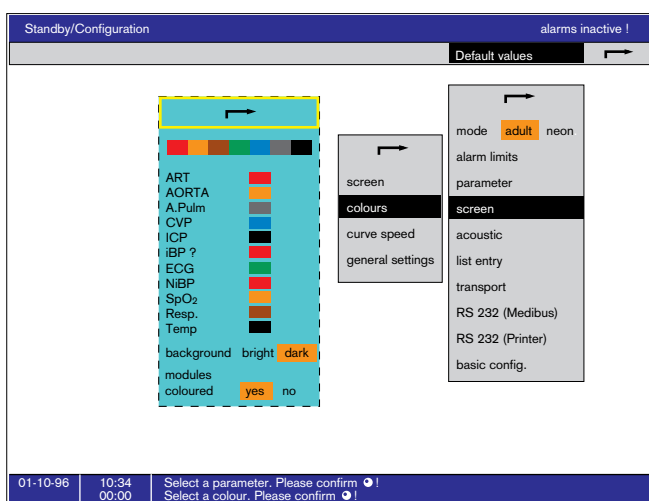

Example:

Screen with dark background

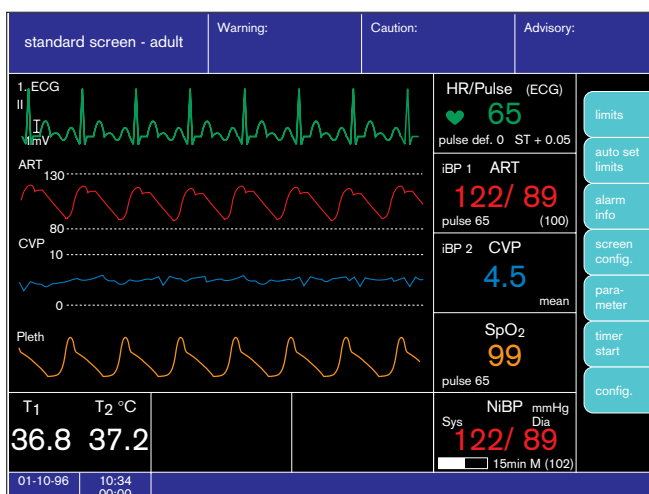

Configuring the curve speed

The speed of the curves is determined in mm/s for the following measured values:

haemodynamic adults

Haemodynamic values in adult mode.

haemodynamic neonates

Haemodynamic values in neonatal mode.

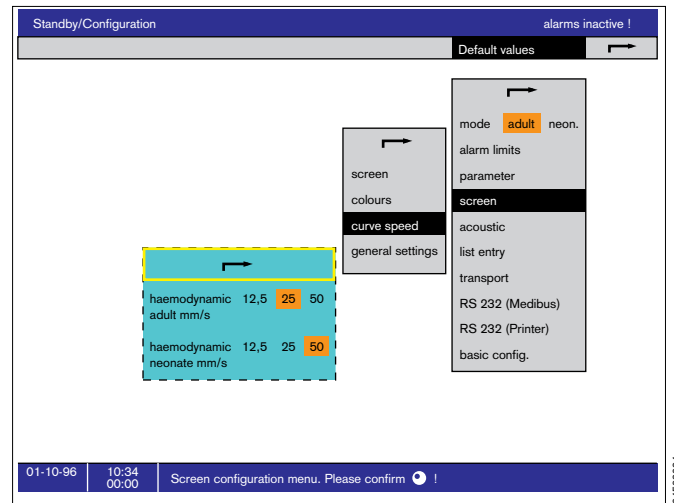

Configuring the general settings

The following units can be switched on or off:

unit

»yes« = ON

»no« = OFF

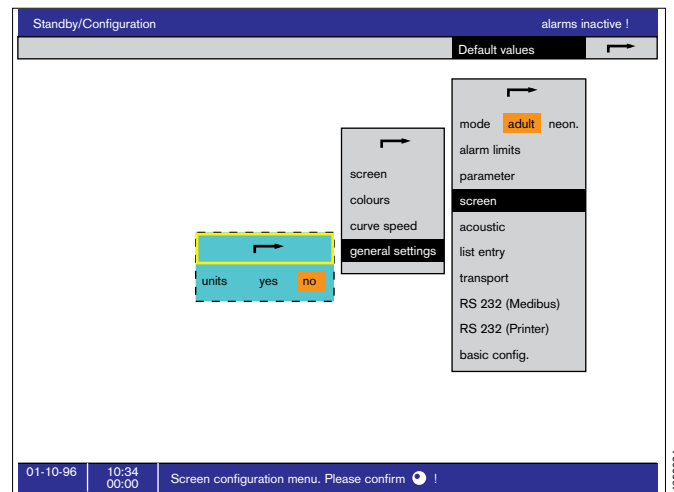

Acoustic

The volume and tones are defined here.

»0« means »off«, while »1« is the lowest and »9« the highest volume.

alarm sound Volume of the alarm sound

pulse tone Volume of the pulse tone

ECG Tone - SpO2 modulated

Acoustic heart beat signal.
If »yes« is selected, the pitch of the heart beat tone varies with oxygen saturation.
If »no« the plain heart beat tone is of invariable pitch.

tone sequence

Specifies the tone sequence, either to Euro- or to Dräger standard.

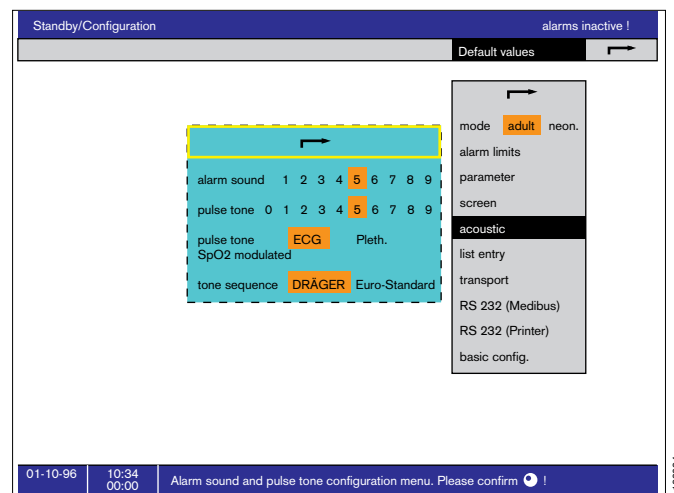

List entry

This option opens a menu in which you can define the times (fixed intervals) or events (warning, caution, NiBP measurement) that generate list entries.

In addition, this menu defines which blood pressure source is represented.

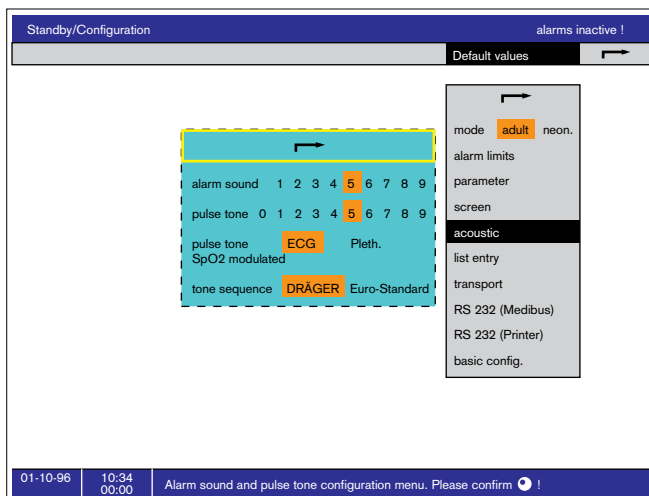

Transport function

The parameter box stores the following data from the system monitor:

- patient data for the list screen,
- alarm limit settings and
- measurement parameter settings.

The patient therefore remains connected to the parameter box while in transit. The patient's data is continuously available. There is no need to reconnect and set monitors. A complete list of transportable data is given in the chapter »**Technical Data**«.

The transport function can be preset in »**Standby**«.

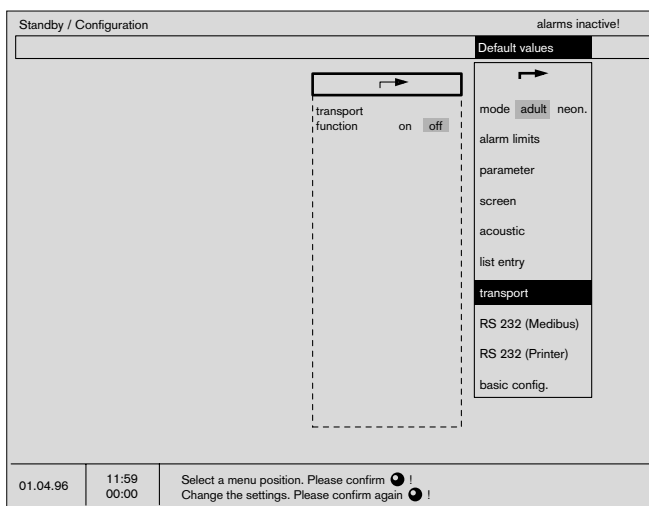

Transport function on/off

When the transport function is »**off**«, no data is exchanged between the system monitor and the parameter box (for stationary use of the parameter box).

When »**on**«, data is communicated.

Transport menus yes/no

If set to »**no**«, data is transferred during operational use according to the default settings in »**Standby**« (fully automatic process).

If »**yes**«, the user has the option of modifying the type and scope of the data transfer. The displayed transport menu always corresponds to the default settings described here (semi-automatic mode).

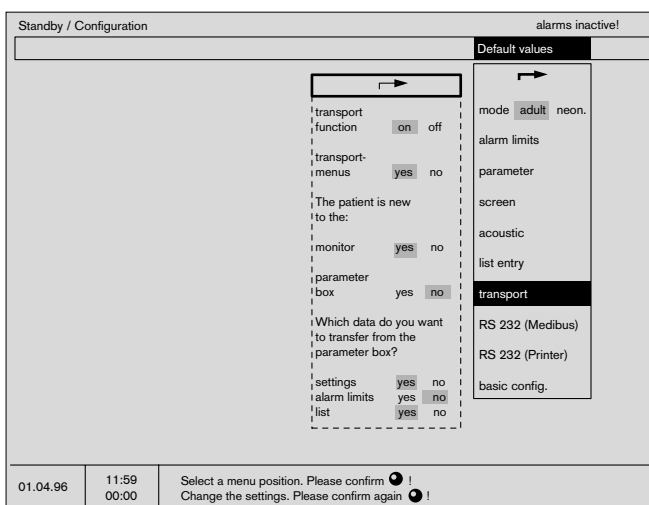

The patient is new for ...

If a patient is connected for the first time, no data on the patient is yet stored in the system monitor or parameter box. This case will generally apply in the induction room. (see the example in the left-hand of the two isolated menus opposite).

- 1 In this case, »yes« must be entered both for »system monitor« and for »parameter box«.

Any data remaining from the previous patient will be deleted.

- 2 If the patient arrives with a connected parameter box, i.e. with a "previous history", enter »no« after »parameter box«: the data from the parameter box will be transferred to the system monitor. This case will generally apply in theatre or recovery room. (See the example in the right-hand of the two isolated menus opposite).

The following dialogue then appears on the system monitor:

»Which data do you want to transfer from the parameter box?«

Settings yes/no

If »yes«, the measurement parameter settings are transferred from the box (e.g. iBP calibration, mode, NiBP interval, ECG amplitude etc.)

If »no«, the current system monitor values remain valid.

Alarm limits yes/no

If »yes«, the alarm limits are transferred.

If »no«, the current system screen values remain valid.

List yes/no

If »yes« the data stored in the parameter box is transferred and inserted in the list.

If »no« the system screen sets up a new list. The new list is valid ("start-time") as soon as these settings have been validated.

In normal operation (see section on »Parameter Box«), this dialog only occurs when »Transport Menus« is set to »yes«. Otherwise, the instructions programmed here are executed immediately.

In standardised operating theatre organisation, the transport menus can also be switched off (Transport Menus set to »no«). In this case, data is transferred as specified by the preselected settings, without any further dialog or confirmation.

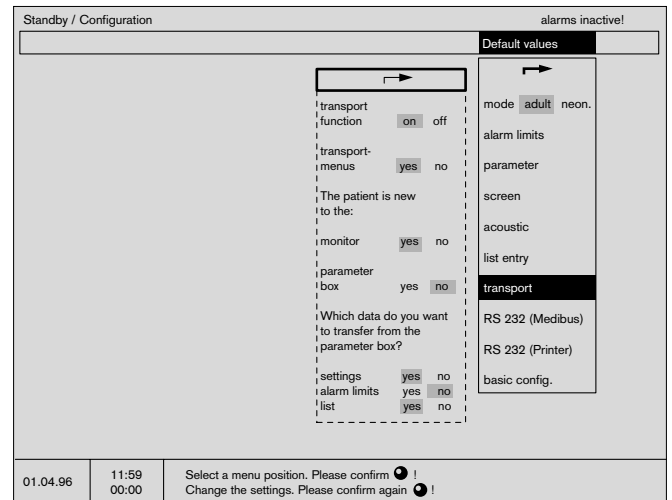

1

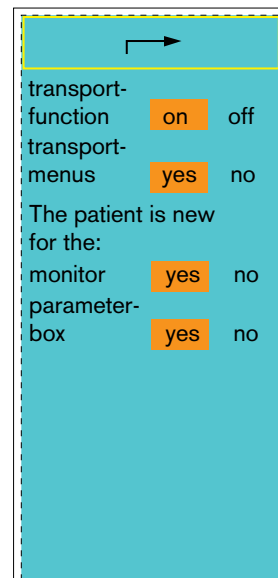

2

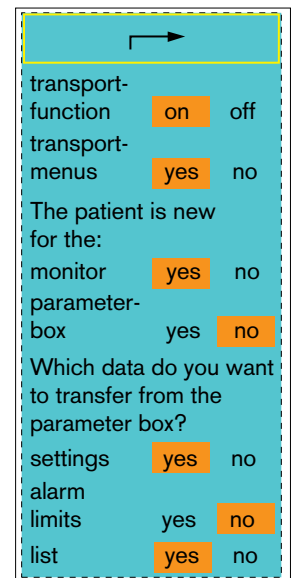

RS 232 (MEDIBUS)

This menu is used to configure the data transfer interface:

baud rate Transmission speed (variable, see Instructions for Use of the device you wish to connect).
1.2 or 9.6 kBaud

The following parameters are displayed for information only and cannot be changed:

parity even

data bits 8

stop bits 1

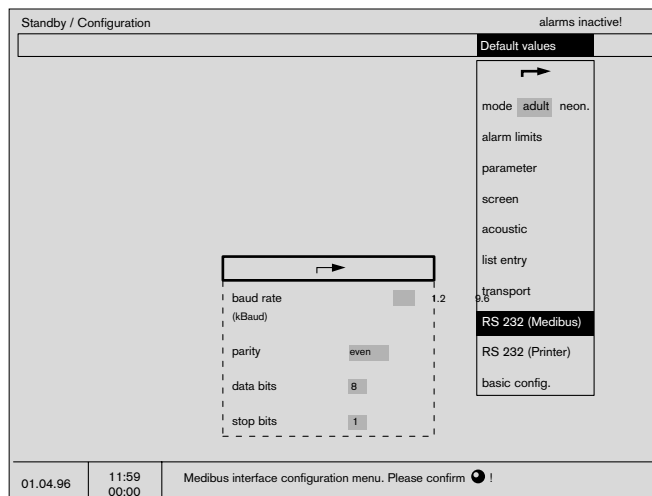

RS232 (Printer)

This menu is used to configure the interface for data transfer to a printer (see Instructions for Use of the device you wish to connect).

select protocol Selects whether the interface should be used for a printer or as an additional MEDIBUS interface

baud rate Transmission speed

parity Parity of the check bits

data bits Number of data bits

stop bits Number of stop bits

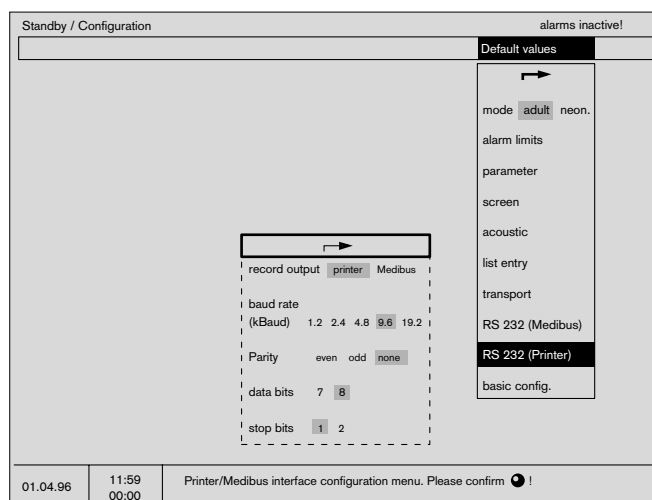

Basic configuration

The basic configuration comprises the following items:

- **time** for the current time
- **date** for the current date
- **language** for the language version. The following languages are available:

English	GB
French	F
German	D
Dutch	NL
Italian	I
Spanish	E
Danish	DK
Swedish	S
Norwegian	N
- **location** The location of the machine can be entered with a maximum of 9 alphanumeric characters. This location name will then be displayed in the list after the defined interval.

This menu is automatically closed on confirming the 9th character.

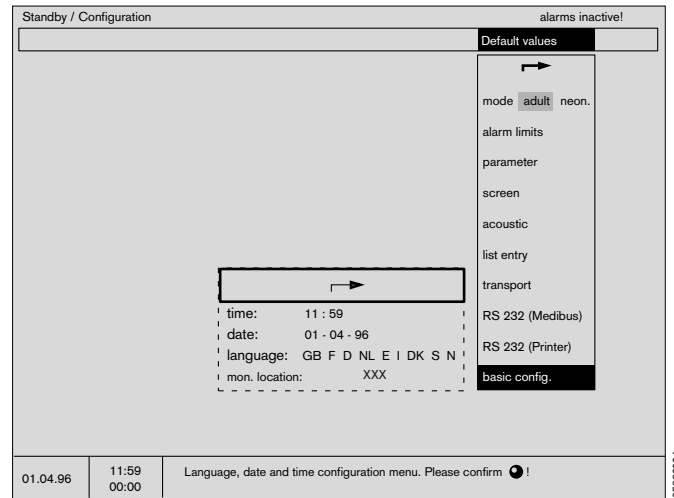

Screen functions during operation

Starting up the screen

- 1 Press the  key.

The standard screen is displayed.

- 2 To call up other screens:
Press the  key.

A selection menu for the following screens is displayed:

- **Standard screen 1,**
 - **Standard screen 2,**
 - **List screen** and
 - **Trend screen.**
- 3 You can return directly to the »Standard screen« at any time by pressing the  key.

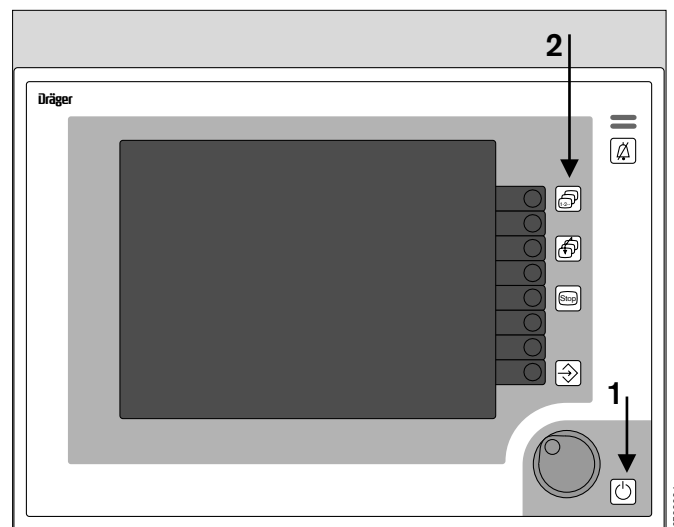

Screen functions
Screen functions during operation

- **Standard screen**
contains the graph and measured value fields configured by the user.

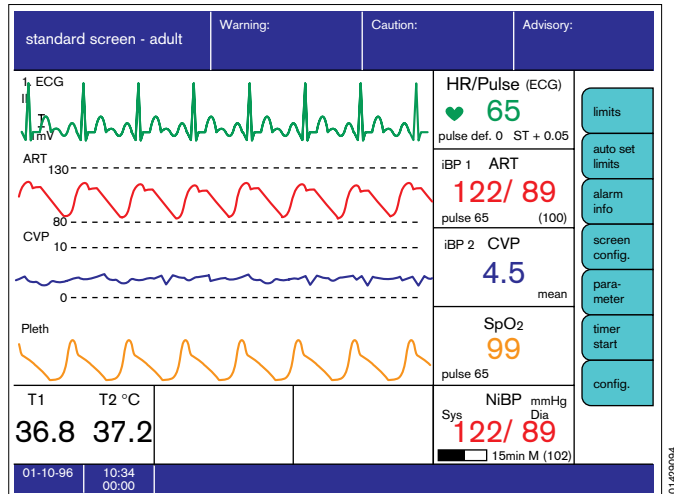

- **The list screen**
contains all the measured values and alarms which have been saved and makes it easier to complete the anaesthetic record (see page 38). The uppermost graph of the standard screen is shown at the top.

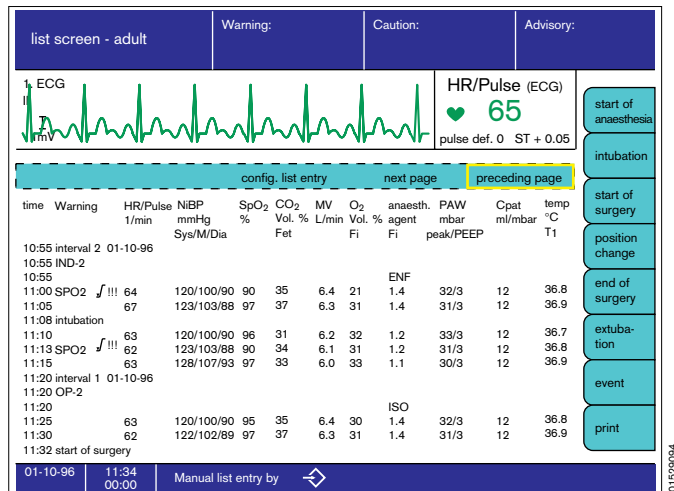

- **The trend screen**
shows graphically the measured values over time. The uppermost graph of the standard screen is shown at the top.

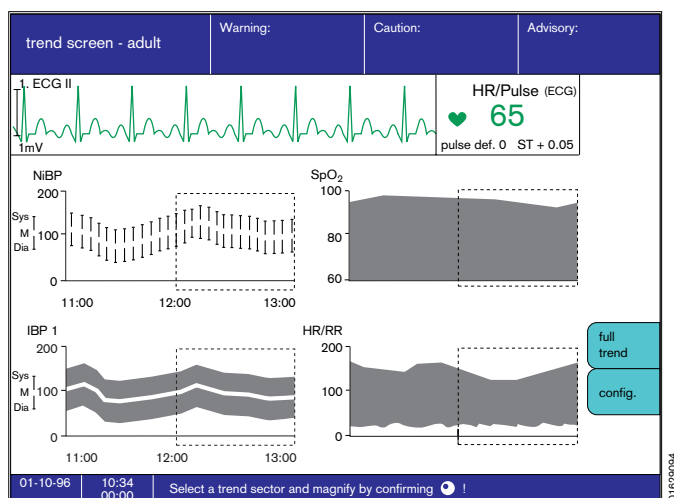

Standard screens

The standard screen is preconfigured by the manufacturer.

The configuration of these screen pages is described from page 26 onwards.

The screen keys (softkeys) are described from page 38 onwards.

Example »standard screen«:

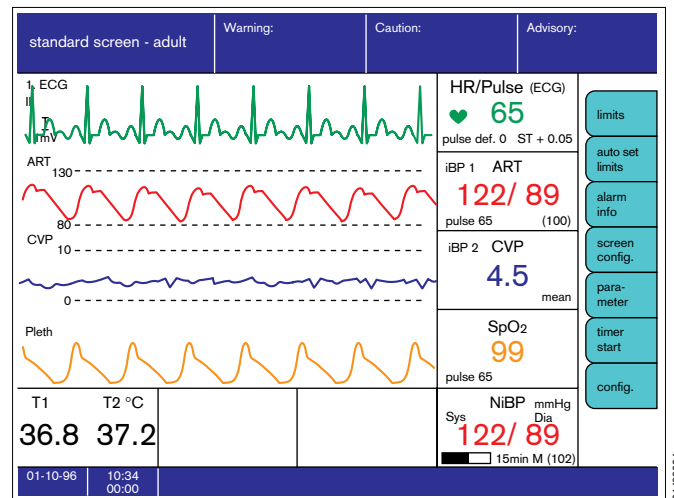

List screen

Certain measured values which have been automatically or manually saved are displayed here for documentation (to facilitate compilation of the anaesthetic record).

An interval, limited by clipping the parameter box in and out, is displayed in the list by the label »interval« and the associated location of the machine.

The list can contain a maximum of 100 lines.

This page also contains ventilation parameters imported via the MEDIBUS interface.

The measured values and the warning or caution messages triggering them are recorded line by line, together with the time, either at specified intervals and/or as a function of warning or caution messages or of an NiBP measurement.

A list entry can be generated manually at any time by pressing . If entries are made manually, a suitable designation can be selected by means of the on-screen softkeys:

- For example:
- »start of surgery«
 - »transfer patient«
 - »Intubation«

A paper printout of the entire list is generated on an external connected printer by pressing the »print« screen key.

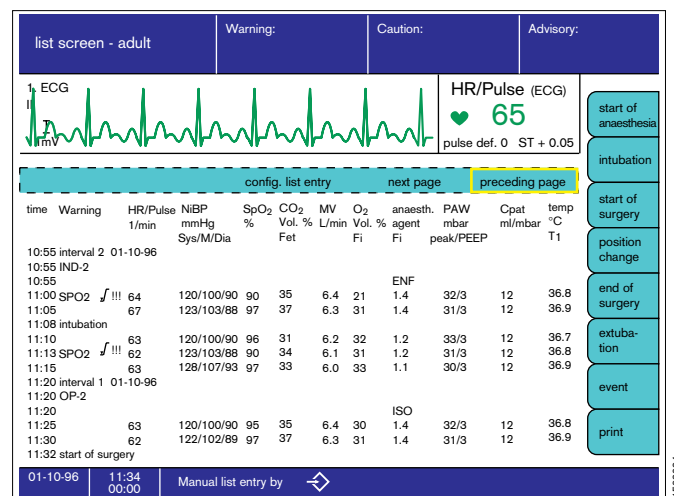

Screen functions

Screen functions during operation

The list may continue for several pages, so that it may be necessary to »leaf through« in order to locate a specific entry.

Return to previous page:

- Turn rotary control to select »previous page« and press to confirm.

Continue to next page:

- Turn rotary control to select »next page« and confirm.

Define list entry:

- Select »list entry« with the rotary control and confirm. A menu appears for you to select at what times (fixed intervals) or events (warning, caution, NiBP measurement) list entries should be made.

In addition, this option is used to define the blood pressure.

The list entries for the currently used screen can also be modified later.

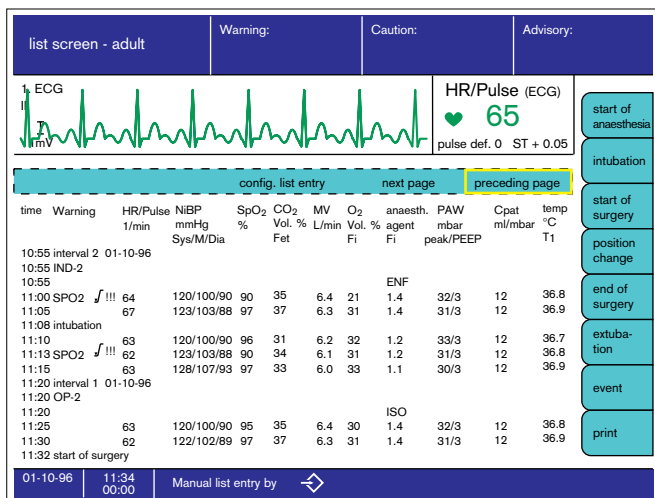

Deleting the list and trend memory:

The trend memory and list are deleted together. They can only be deleted in »Standby« mode. If the parameter box is connected, the data in the parameter box will also be deleted!

- Press the  key to switch over to standby mode.
- Press the »delete trend« softkey.

The system asks you to confirm that you are sure you want to delete the trend.

- Press the »delete« softkey to confirm.

To restore the unchanged screen without deleting, press »do not delete«.

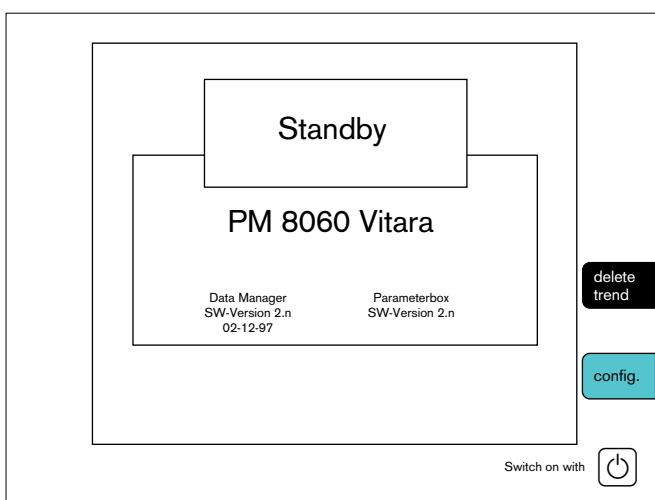

Trend screen with zoom function

This screen displays the histories of the following measured values, in the form of value curves as a function of time since the start of measurement:

- NiBP,
- iBP 1,
- SpO₂ and
- HR / RR

In the heart rate field (HR), the respiration rate (RR) is displayed on the same scale (cardio respirogram).

The values can be stored for a maximum of 8 hours.

The zoom function can be called up when the system has been in operation for more than 30 minutes. A segment of the time range can be enlarged (possibly several times) with this function. The segment is identified by a dashed border. The past is located on the left. Example:

- Turn rotary control - area changes.
- Press rotary control - the dashed area is extended to cover the full display width.

If the monitor has been in operation for a sufficiently long period of time, a new dashed area appears and can then be extended as described above.

The maximum has been reached when no additional dashed frame appears.

Back to full trend:

- Press »full trend« in order to redisplay the complete trend.

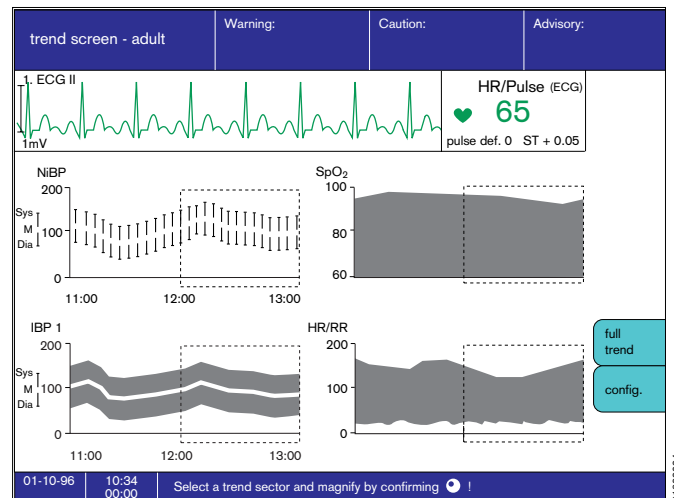

Limits

The display comprises the designation of the measured value, the value actually measured on the patient (large numerals) and the set upper and lower alarm limits (small numerals) underneath the symbols for the alarm limits (« $\sqrt{\quad}$ » for the lower and « $\sqrt{\quad}$ » for the upper alarm limit).

A deactivated alarm limit is indicated by dashes (--) in the numbers field.

The limit value settings only apply temporarily. They are overwritten by the standard alarm limits when

- the PM 8060 vitara is switched off.
- the monitor is switched to **»Standby«**.
- the setting **»Default«** is selected and confirmed under **»Config«** and **»Alarms«**.

To change alarm limits:

- Move the cursor frame to the value for the required alarm limit with the rotary control and press to confirm.
- The value can then be altered by turning the rotary control until the required value has been obtained.
- This value is confirmed by pressing the rotary control
 - this value now represents the active limit.

For information on the links between certain alarms, please refer to the section describing the **»alarm concept«**.

The limit value menu is automatically displayed whenever an alarm limit has been violated (see **»alarm concept«**).

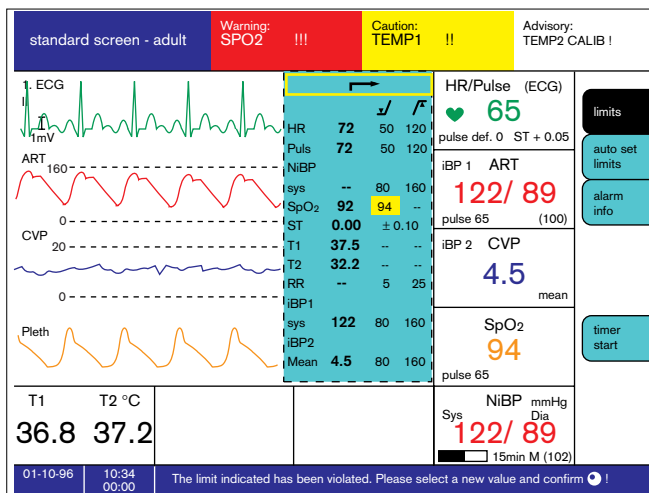
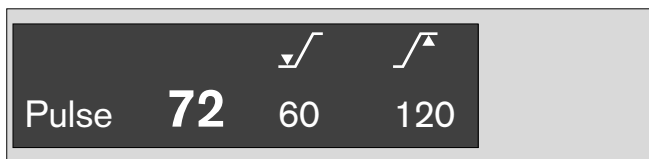

AutoSet Patient Alarm

Alarm limits can also be set **automatically** for a **situation recognised as stable**.

Press the »**auto set pat. alarm**« softkey **once** to set a tolerance range for **monitored** measured values, with new upper and lower alarm limits.

The alarm limits set in the »**limits**« menu are deleted and cannot be reactivated. The default alarm limits remain unaffected by the auto set function and can be reactivated at any time via the functions »**config**«, »**alarms**« and »**default**«.

The alarm limit for SpO₂ remains unaffected.

The autoset function is not permitted to set the lower alarm limits for the heart rate to less than 40 beats per minute and for the systolic pressure values to less than 90 mmHg.

Alarm limits that have been deactivated (– –) are not activated by AutoSet.

The new tolerance ranges generated for the current measured values depend on the parameter in question:

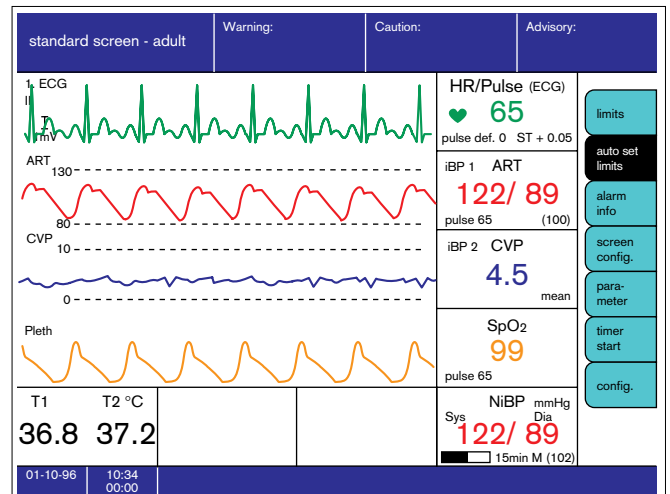

Parameter		new meas. value tolerance		unit	comments
		upper	lower		
ECG	HR	+20.0	-20.0	¹ /min	but not less than 40 per minute
	ST	+0.05	-0.05	mV	
NiBP/ART	SYS	+20.0	-20.0	mmHg	but not less than 90 mmHg (»Neo« not less then 50 mmHg)
	DIA	+20.0	-20.0	mmHg	
AORTA	SYS	+20.0	-20.0	mmHg	
	DIA	+20.0	-20.0	mmHg	
ART pul.	SYS	+15.0	-15.0	mmHg	
	DIA	+5.0	-5.0	mmHg	
	MIT	+10.0	-10.0	mmHg	
CVD	MIT	+5.0	-5.0	mmHg	
ICP	MIT	+5.0	-5.0	mmHg	
	SYS	+20.0	-20.0	mmHg	
	DIA	+20.0	-20.0	mmHg	
mmHg	MIT	+20.0	-20.0	mmHg	
	SYS	+20.0	-20.0	mmHg	
	DIA	+20.0	-20.0	mmHg	
TEMP		+1.0	-1.0	°C	
RESP	RR	+40.0	-40.0	% meas. val	but not outside the following min./max. limits: Adults with RR < 6 per minute and > 30 per minute Neonates with RR < 12 per minute and > 60 per minute

Alarm info

The warning, caution and advisory fields each have space for two to three entries.

If further messages are present, a complete list of all entries in order of priority can be displayed on the monitor by pressing the softkey »alarm info«.

The list can be read as long as the key is pressed.

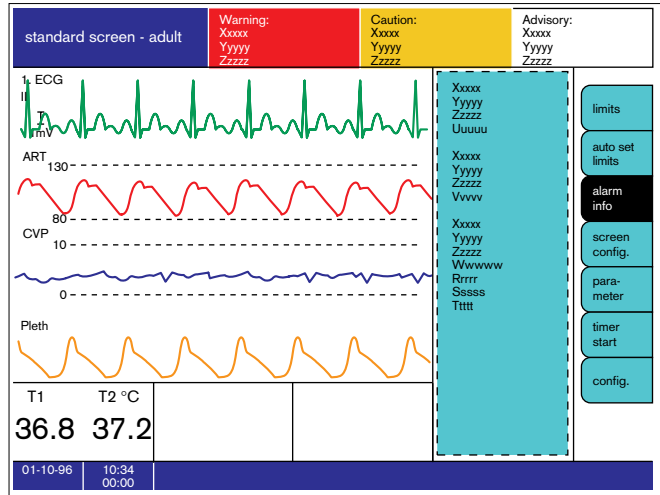

Screen configuration

A selection menu is displayed when the softkey »screen config.« is pressed.

The graphs and numerical modules are selected as described from page 27 onwards.

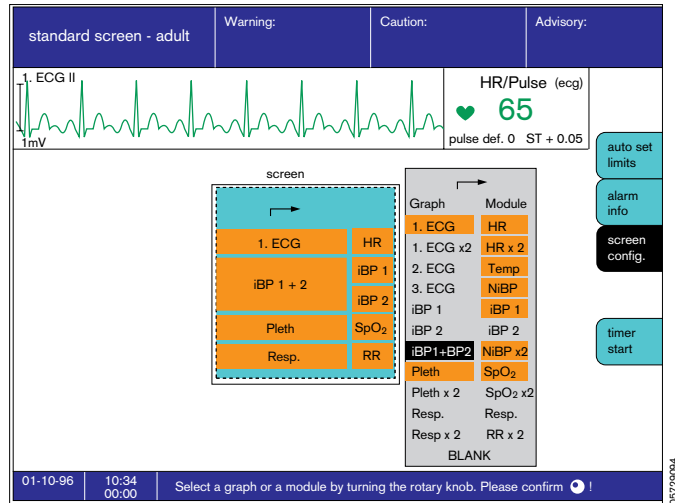

Parameter

Press the softkey »Parameter« to display a selection menu with the functions »ECG«, »NiBP«, »iBP1«, »iBP2«, »SpO2/Pleth« and »Resp.« on the screen.

The procedure for setting the parameters for »ECG«, »NiBP«, »iBP1«, »iBP2«, »SpO2/Pleth« and »Resp.« described in detail in the section headed »Parameter box« (from page 49 on-wards).

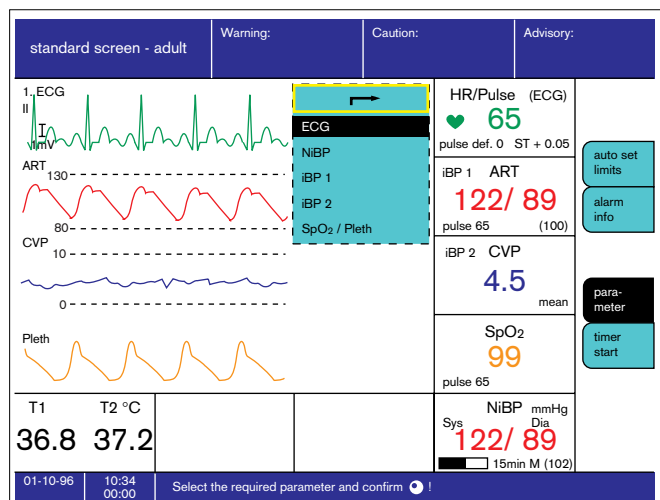

Timer

- Press the »timer start« softkey to start the timer at »00 : 00«.
- Format: »Min. : Sec.«
- 1 The timer reading is shown on the screen below the normal time. The softkey changes automatically to »timer stop«.
- Press the softkey again to stop the timer. The display will be cleared on switching to »Standby«.

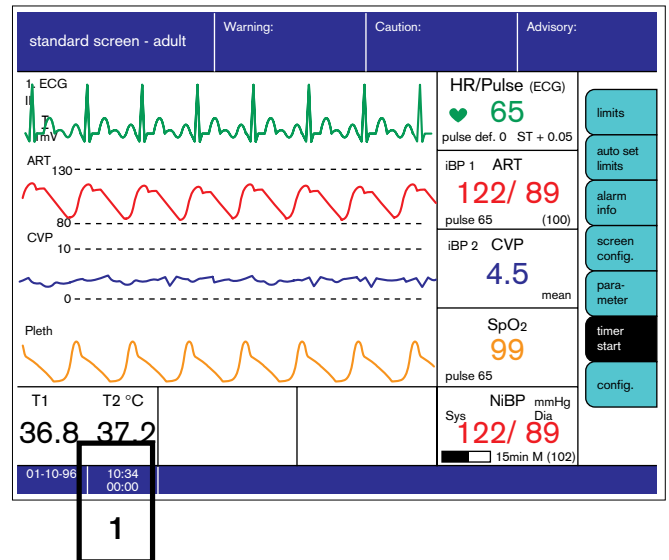

Configuration

This softkey calls up the configuration menu. These settings will only remain valid until the machine is switched off or switched to »standby« mode!

The menu for configuring the default values is displayed with the following settings:

Settings

- **mode** Switches between adult and neonatal modes (toggle function).
- **alarm sound** Sets the volume.
- **pulse tone** Sets the volume of the pulse tone.
- **ECG-Tone - SpO2 modulated** Acoustic heart beat signal. If »yes« is selected here, the pitch of the heart beat tone varies with the oxygen saturation. If »no«, the heart beat tone remains of invariable pitch.
- **colour** Sets the colour configuration.
- **curve speed** Determines the speed of the haemodynamic curves.
- **call standard** Activates all parameter settings configured in »Standby« (but not the default alarm limits!).

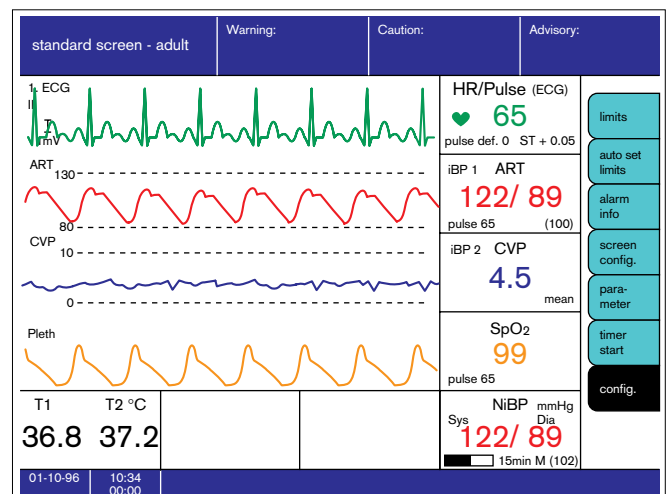

Calibration

- **iBP 1/2** Invasive blood pressure sensor in channel 1 or 2.
- **check NiBP** Checks the NiBP pneumatic measuring circuit for leaks.

Alarms

- **default** Activates all standard alarm limits configured in »Standby«.
- **SpO2** Activates/deactivates all SpO2 alarms.
- **parameter box** Activates/deactivates all parameter box alarms.



06128054

Alarm concept

Alarm priority

The monitor alarms are arranged in order of priority and assigned specific tones or tone sequences. The alarm messages, adapted to the particular situation, are displayed in an easily understandable layout with separate fields for

1 Warning marked	»!!!«	Text on red field
2 Caution marked	»!!«	Text on yellow field
3 Advisory marked	»!«	Text on white field

Warnings are accompanied by a continuous tone, caution messages by an intermittent tone with an interval of 30 seconds and advisory messages by a single beep. Tones conforming to either the Euro standard or Dräger standard are available. Under the Euro standard, the warning tones are separated by pauses of about 15 seconds.



4 Whenever a warning or caution message occurs, the corresponding LED lights up above the  keys:

Warning	Red, flashing
Caution	Yellow, flashing
Advisory	Yellow, continuous

The summary of alarm limit settings appears on the screen, and the exceeded parameter is displayed in inverse video.

Example:

The lower alarm limit for SpO₂ is set to 95 %, and the actual value is below the limit.
The measured value is 94 %.

- The settings menu is automatically opened. The violated upper or lower alarm limit is shown in inverse video.
- The symbol for the lower alarm limit  and the parameter designation »SpO₂  !!!« are displayed in the alarm field.
- The red LED lights up.
- The corresponding tone is heard.
You can change this value by turning the rotary control and confirm the change by pressing the control.

If you do not want to change the alarm limit, you can immediately press the rotary control to confirm the existing value. Pressing the rotary control, at whatever stage, always closes the alarm limits menu. However, the message »SPO₂  !!!« will remain in the alarm window.

If other alarms have been generated at the same time, the relevant alarm limits will be shown against a dotted yellow background. After you have acknowledged the first alarm (by pressing the rotary control on the monitor), the alarm limit with the next lower priority is activated and displayed.

All the received alarms are logged for the anaesthesia record if list entry has been configured for this function.

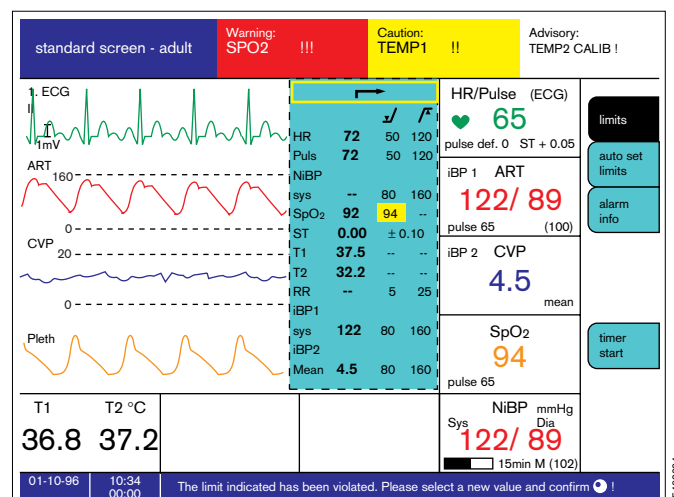
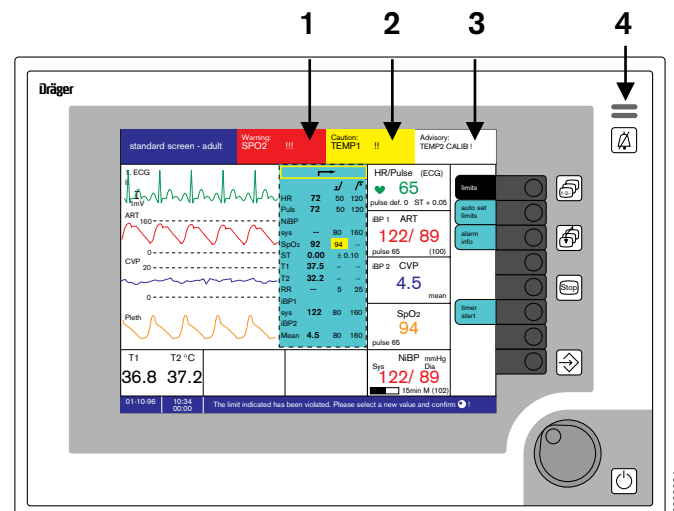

09528094

05428094

Show all alarms

- 1 Press the softkey »alarm info«.
The alarm texts of all warning, caution and advisory messages are displayed in order of priority.

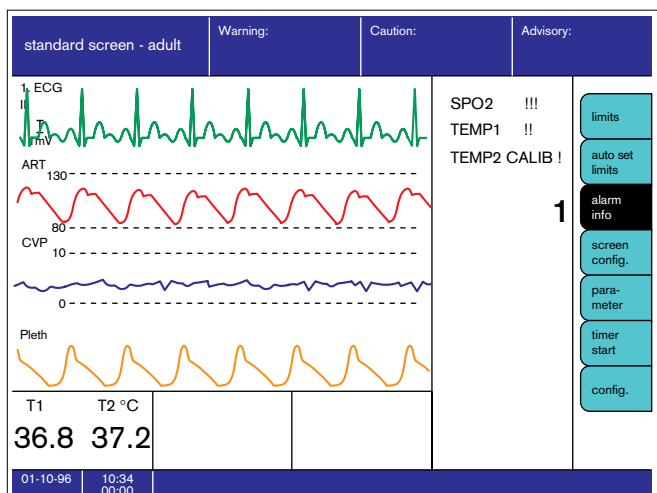

Suppress alarm tone:

- 2 Press key  on the monitor or on the parameter box. The yellow LED of the relevant key lights up. The alarm tone is then suspended for **2 minutes**. However, any new message occurring during this time will be indicated once with its appropriate specific tone.

Exception:

NiBP alarms are suppressed until the next measurement is taken.

- 3 The red (upper) or yellow (lower) lamp remains lit, and the text remains on the display.

To reactivate the alarm tone before the end of the 2-minute period:

- 2 Press  again, and the corresponding yellow LED goes out.

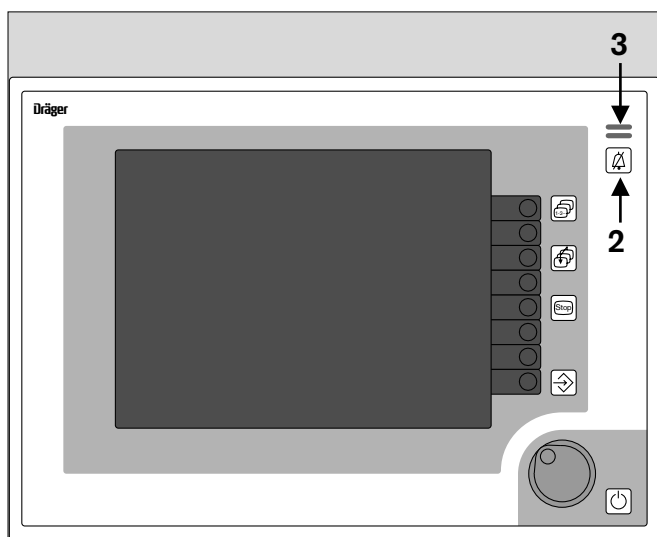

To avoid confronting the user with an unmanageable quantity of individual alarms, combination alarms have been programmed for logically related alarms.

Linkage between alarms for no pulse or heart rate:

The pulse rate is determined from the SpO₂, iBP 1 and iBP 2 measurements. The heart rate is determined from the ECG.

If one of the four parameters is deactivated, the logic of the remaining three is applied. If a further parameter fails, the link between the remaining two alarms is cancelled, and a separate alarm is signalled for each parameter.

Measurement	Result	Message	Special features
ECG SpO ₂ IBP 1 IBP 2	No heart beat any any any	ASYSTOLY !!!	
ECG SpO ₂ IBP 1 IBP 2	heart beat pulse no pulse no pulse	IBP 1 PULSE? !!!	
ECG SpO ₂ IBP 1 IBP 2	heart beat pulse pulse no pulse	CHECK IBP 2 !	
ECG SpO ₂ IBP 1 IBP 2	heart beat pulse no pulse pulse	CHECK IBP 1 !	
ECG SpO ₂ IBP 1 IBP 2	heart beat no pulse pulse pulse	SPO2 SENSOR? !	
ECG SpO ₂ IBP 1 IBP 2	heart beat no pulse no pulse no pulse	SPO2 PULSE? !!!	

Monitoring the alarm limits for pulse rates from different sources:

The heart rate is always determined from the first ECG.

To monitor the pulse rate, two out of three parameters (SpO₂, iBP 1 and iBP 2) are considered. If two parameters output a measured value in the range between the alarm limits, the advisory message »CHECK xyz« is generated instead of a pulse alarm.

A pulse alarm is only generated if at least two parameters indicate a violation of the alarm limits. If a third parameter fails, the link between the alarms is cancelled, and a separate alarm is signalled for each parameter.

Monitoring the alarm limits of the blood pressure values from different sources:

The NiBP alarm is deactivated during simultaneous ART and AORTA measurement.

The standard alarm limits for NiBP and ART are coupled.

NiBP alarms are suppressed by pressing  until the next NiBP measurement is performed.





Parameterbox

Contents

Function keys	50
Indicators.....	50
Transport function.....	51
ECG / Heart rate.....	53
Non-invasive blood pressure (NiBP).....	56
Invasive blood pressure (iBP).....	61
Functional O₂ saturation of the blood (SpO₂).....	64
Temperature measurement.....	69
Respiration.....	70

Function keys

The parameter box is controlled by the PM 8060 vitara. A number of functions can be accessed quickly and directly via the function keys:

-  Suppresses all acoustic warnings for 2 minutes. The yellow LED in the key lights up during this time. New alarms will be signalled once with their specific tone.
-  Starts the automatic NiBP measurement. The yellow LED in the key remains lit as long as »Auto« mode remains active.
-  This key is used to start and end NiBP measurement.
-  This key is used to build up a static pressure in the NiBP cuff to constrict the venous blood flow. The yellow LED in the key lights up during this time. Press the key again to release the pressure. In all events, the pressure will be automatically released after 2 two minutes. The pressure is set by the user in the NiBP menu.
-  Zero alignment key for invasive blood pressure measurement. The infusion system must be exposed to atmospheric pressure and **the key pressed twice**.

When the message »CAL« appears on the monitor:

- Check the position of the shutoff valves.
- Does the pickup still detect an arterial pulse?
- Check pressure pickup.

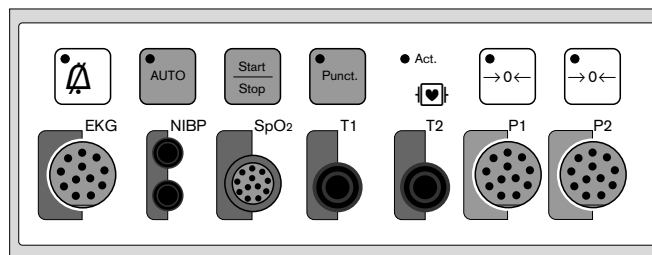

Indicators

- 1 ● **Act.** Power indicator (activation indicator).

Lights up when the parameter box is active. Shortly after inserting the parameter box into the holder, the yellow LED begins to flash until communication with the monitor has been established.

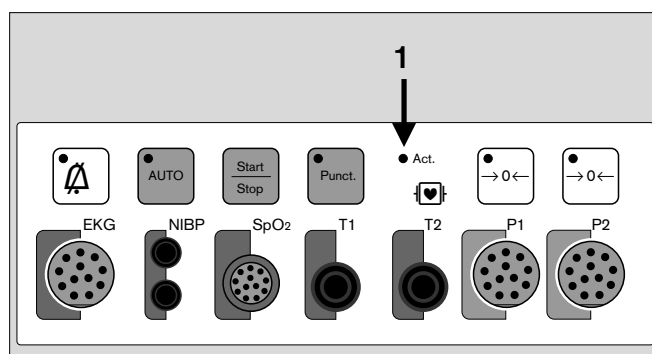

Transport function

The parameter box stores:

- patient data from the list screen,
- alarm limit settings and
- measurement parameter settings.

Engaging and releasing the parameter box

Blue holder:

In this holder, the parameter box can swivel up and down. After exceeding a specific holding force it can be adjusted to an ergonomically favourable position.

To engage:

- Hold the parameter box by the blue handle.
- Place the parameter box on the crossbar of the holder, and swivel the box downwards.

It clicks audibly into place, and all the LEDs on the front panel light up briefly.

To release:

- Pull out the blue handle. Swivel the box upwards to disconnect the electrical connections, and lift it off the crossbar. It is now freely transportable.

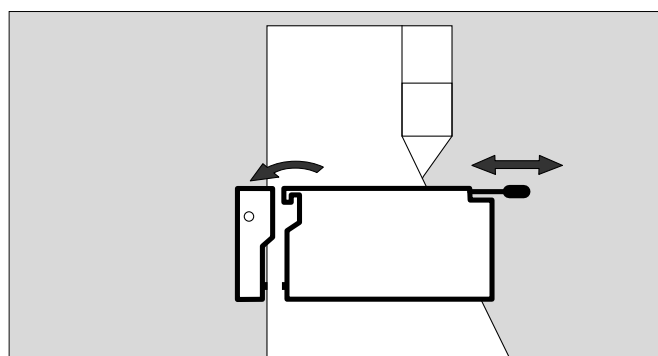

08/2004

White housing (optional):

To engage:

- Hold the parameter box by the blue handle.
- Slide the parameter box into the white holder.

It clicks audibly into place, and all the LEDs on the front panel light up briefly.

To release:

- Pull out the blue handle. After overcoming a tangible resistance, the box is electrically disconnected and freely transportable.

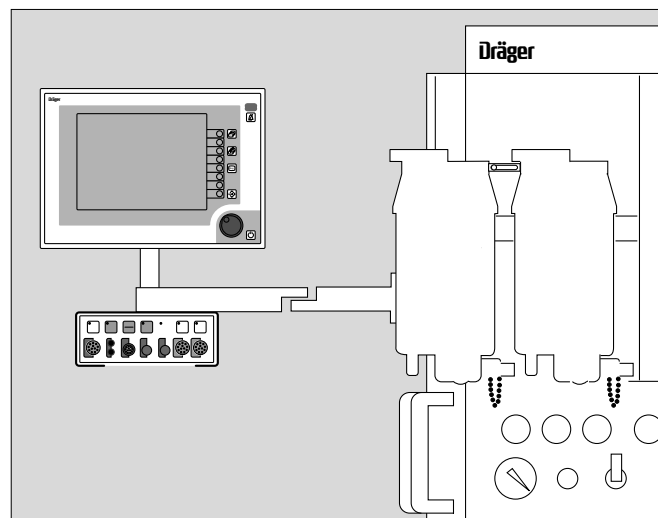

02/2004

Holder for operating table:

Alternatively, the "Op. Table" parameter box holder can be used. This holder is especially suitable for fixing close to the patient. It can remain on the operating table or bed when transporting the patient. The parameter box is connected to the PM 8060 vitara by means of the quick-release cable.

This system is not compatible with the holders with clip-in mechanism.

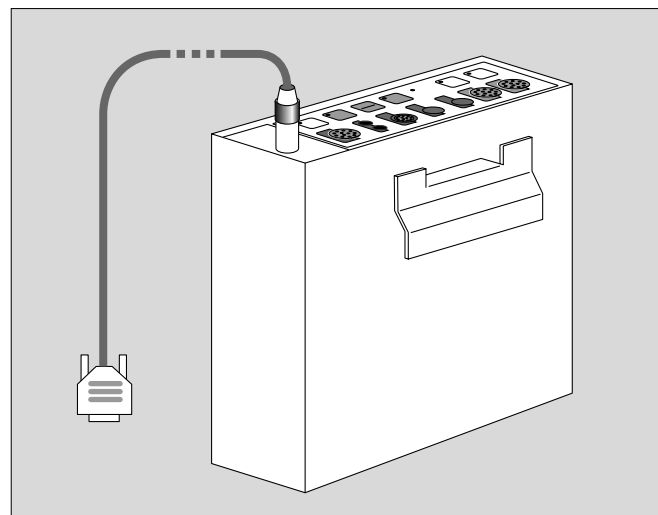

08/2004

Data transfer

As soon as the parameter box has clicked into place, it exchanges your data with the system monitor. The monitor performs as programmed in »Standby« (see Page 32).

A complete list of the transported data is given in »Technical Data« on page 89.

Fully automatic procedure

The advisory message »data being transferred as requested« is displayed.

After about 12 seconds, the new configuration is active. No user intervention is required.

Semi-automatic procedure

The transport menu appears, as preconfigured by the user in »Standby«.

If the monitoring requirements have changed in the meantime, the user can intervene in the data transfer and modify settings in the same way as for the configuration in »Standby«.

The data transfer can of course also be confirmed unchanged after checking the display.

- Press the rotary control to confirm these settings. All parameter box functions will then be activated after about 12 seconds.

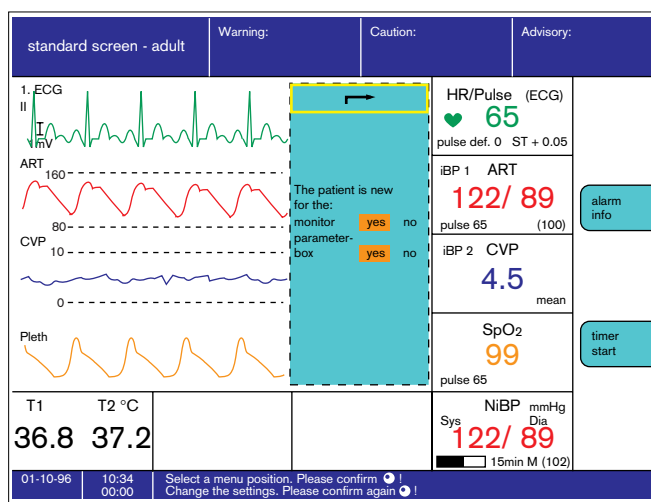

List intervals

If you opt for list data transfer in the semi-automatic procedure, you can now select the intervals.

A (monitoring) interval is the time between the engagement (connection) and release (disconnection) of the parameter box.

In the list screen, each interval is displayed on a separate line and marked »start interval« and »end interval«.

List from interval:		
Date	time	
every session		
03	04-10	16:33/17:30
02	04-10	17:32/17:42
01	04-10	17:32/17:42

ECG/Heart rate

ECG in the operating theatre

The following measures are necessary to ensure an effective ECG, reliable heart rate calculations and patient safety:

- Only use ECG leads with HF protection for HF surgery.
- Never use ECG needle electrodes in the operating theatre when an electro-surgical unit is being used!
- The ECG electrodes must be positioned as far away as possible from the area of surgery and from the neutral electrode of the electro-surgery equipment.
- The ECG electrodes must lie as close together as possible.
- Avoid looping the ECG leads and crossing or routing them in parallel to electro-surgery leads.
- Deactivate pacemaker pulse detection.
- Activate the filter.
- Conductive parts of the electrodes, including the neutral electrode, must not touch other conductive parts, including earth.

Pacemaker pulse detection

The pacemaker pulse detection must be activated if the patient has a pacemaker (see page 24).

The heart rate is normally only calculated on the basis of the ECG complex and not on the basis of the pacemaker pulse.

Particular care must be taken in the case of pacemaker patients, since the pacemaker pulses may be mistaken for ventricular complexes. In such a case, calculation of the heart rate would be continued even in the absence of an ECG!

The following points must also be noted:

- The R-waves of the ECG must be greater than 0.5 mV in order to ensure reliable functioning. If this is not the case, the ECG lead must be changed or the ECG electrodes repositioned!
- Deactivate pacemaker pulse detection if it is not needed.
- Deactivate pacemaker pulse detection in the operating theatre when using electro surgery equipment.

Applying electrodes

- Carefully prepare the areas of skin to which the electrodes are to be applied.
- The electrodes should be positioned in areas in which patient movement will not have a negative effect on the ECG (i.e. not on top of muscles if possible).
- Appropriate points of contact for the electrodes when using 3, 4 or 5 electrodes can be seen from the diagrams alongside.

Abbreviations used in the diagrams:

- Rd** = Red electrode
- Ye** = Yellow electrode
- Gn** = Green electrode
- Bl** = Black (neutral) electrode

Figures 1 and 2

Points of contact when using three ECG electrodes.

The contact points illustrated in Figure 1 are also suitable for monitoring chest ventilation (abdomen ventilation can also be clearly determined if the yellow electrode is applied to the lower costal arch). The contact points in Figure 2 are suitable for monitoring both chest and abdomen ventilation.

Figure 3

Points of contact when using 4 or 5 electrodes (e.g. for S-T segment analysis).

The fifth lead (V-lead) is not shown in the diagram.

Connect the end of the ECG lead with the ECG electrodes to the patient and the other end to the parameter box (colour coded red).

ECG Display

- 1 The ECG of the desired derivation is displayed on screen as defined in the configuration menu.
- 2 The heart rate is displayed after about 60 seconds.

If no ECG signal is present, the pulse value is displayed. The signal source is indicated in brackets, in the following order of priority:

- ECG,
- SpO₂,
- iBP 1 and
- iBP 2.

The iBP sources do not generate a pulse tone.

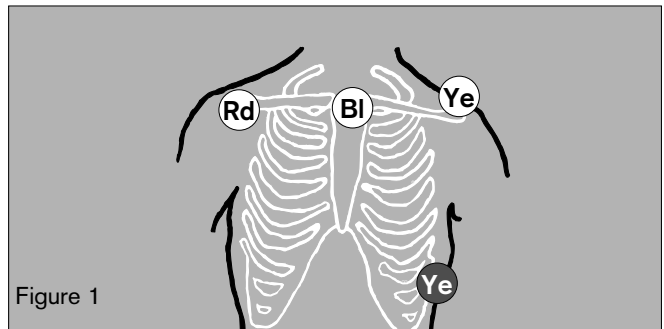

Figure 1

07028094

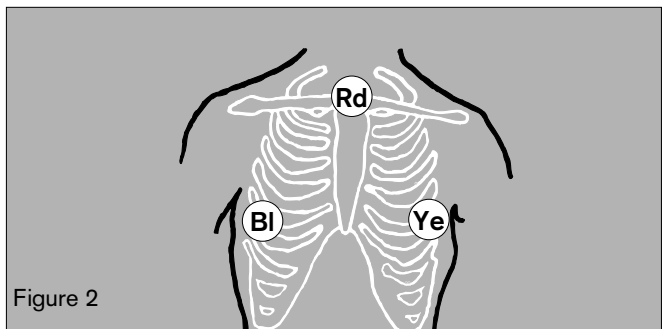

Figure 2

07028094

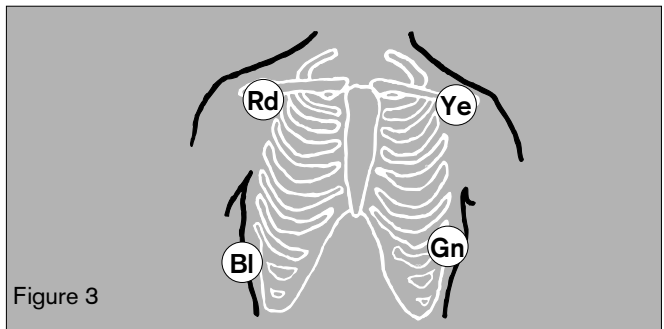
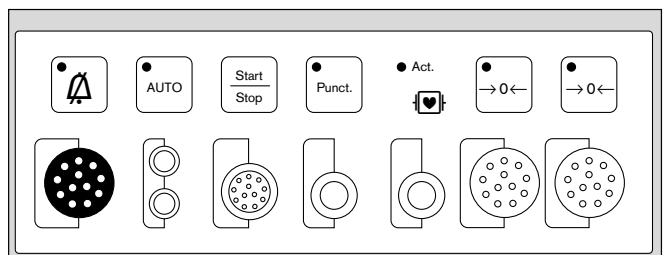
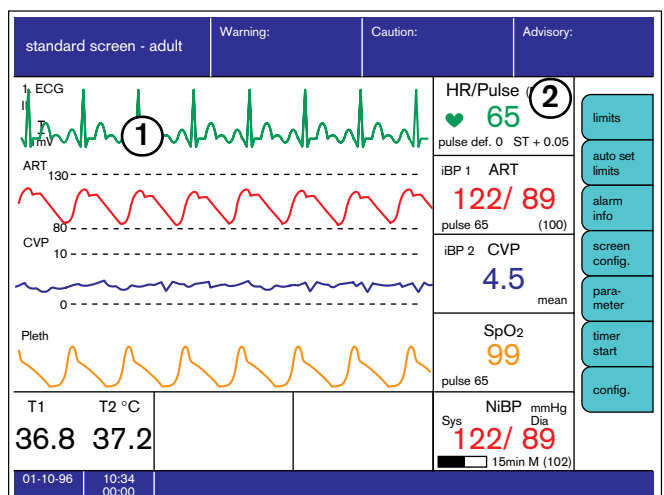

Figure 3

07028094



07128094



07128094

Adjusting settings

- Press the »Parameter« softkey.
The menu for setting the parameters is displayed.
- Move the cursor frame to »ECG« with the rotary control and press to confirm.

function **on / off**
Activates and deactivates the ECG measuring function.

number of leads
3 / 5
The cable type to be used is defined here.
If an ECG cable with 3 leads is used, leads 1, 2 and 3 are available and only one ECG may be displayed. The options for a 2nd and 3rd ECG are cancelled.

The error message »electrode« appears if a cable with four or five leads is selected but only three electrodes are applied.

derivation **1 / 2 / 3 or
I / II / III / aVR / aVL / aVF / V**
The choice of derivations to be displayed is selected here, separately for the 1st, 2nd and 3rd ECG.

Amplitude **4 / 2 / 1 / 0.5 / 0.25**
Sets the ECG amplitude in mV/cm on the monitor, with reference to the reference bar to the left of the ECG graph.

filter **on / off**
»on« yields an extremely stable ECG without interference.
»off« yields an ECG with high frequency resolution, but less stable.

pacemaker **on / off**
Activates and deactivates pacemaker pulse detection.

Pacemaker pulses are enlarged disproportionately when this function is activated (not taken into account when calculating the heart rate).

pulse deficit indication
on/off
Activates and deactivates the pulse deficit indication derived from the heart rate and SpO₂ pulse.

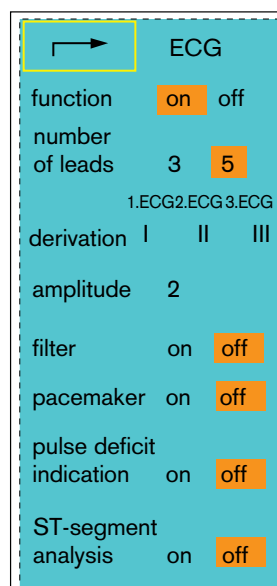
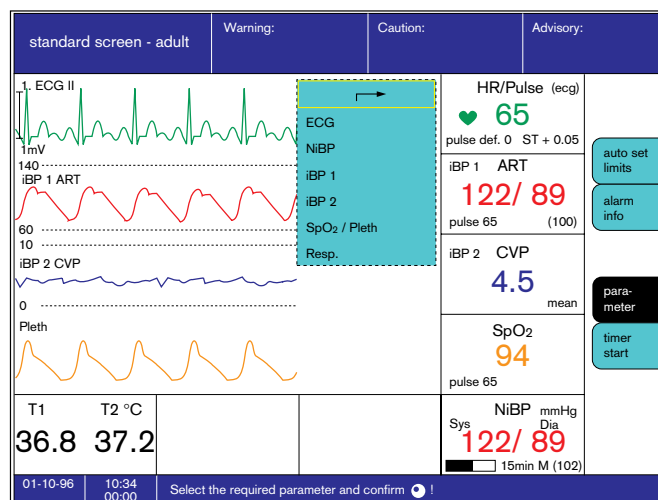

ST segment analysis

on / off

Activates and deactivates ST segment analysis. Alarm monitoring is only active in adult mode. When ST segment analysis is switched »off«, limit value monitoring is deactivated.

ST segment analysis is based on the lead from the 1st ECG.

Simultaneous operation of high-frequency electro-surgery equipment may cause disruptive interference of S-T segment analysis.

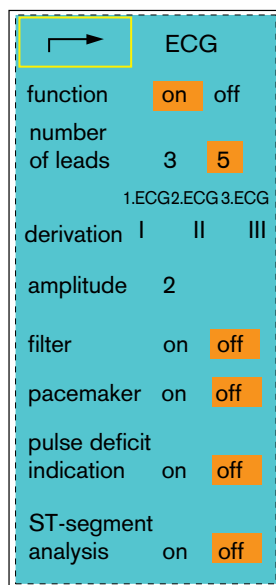

Electro-surgery during an ECG

During electro-surgery or high-frequency surgery, ECG measurements may be susceptible to interference. To prevent unnecessary false alarms, whilst simultaneously ensuring safe monitoring, the system always responds as follows to high-frequency interference:

- the ECG curve is always displayed,
- the message »ECG interference« is displayed,
- the heart rate display is stopped,
- the ECG alarm is suppressed.

After the high-frequency interference subsides, full monitoring activity is restored. If the high-frequency interference lasts longer than 15 seconds, the heart rate value is replaced by dashes (» – – «).

Non-invasive blood pressure measurement (NiBP)

Applying the sphygmomanometer cuff

Correct application of the cuff and use of the correct size are essential prerequisites for reliable measurement without artefacts.

- Only use Dräger cuffs!
- For neonates, make sure that the initial pressure has been suitably set.
- The cuff is normally applied to the upper arm. It can also be applied to the forearm or ankle for prolonged monitoring (less patient discomfort).
- In choosing the limb, make sure that blood circulation will not be impeded by prolonged monitoring and measurement.
- Use the largest possible cuff size.
- Press the remaining air out of the cuff.
- The inflatable part of the cuff must enclose the limb completely (overlapping has only a marginal effect on the measurement), otherwise a disproportionately high systolic pressure will be obtained.

- The cuff must fit snugly in order to minimise tissue movement under the cuff.
- Apply the cuff horizontally, level with the heart. If this is not possible, the difference in level must be corrected by adding/subtracting 0.75 mmHg per cm above/below the level of the heart.
- If the cuff is applied to the upper arm, ensure that it does not compress the ulnar nerve.
- If the arm rests beside the patient, turn the palm of the hand upwards to reduce the pressure on the elbow and ulnar nerves and vessels.
- Ensure that the patient does not speak or move his/her arm during the measurement. Movement of any kind prolongs the measuring time and may lead to incorrect results.
- Ensure that nothing presses, knocks or bumps against the cuff or hose during measurement.
- The cuff has a negative effect on an SpO₂ sensor applied to the same limb. Measure the blood pressure at a different point or activate »interlock« to avoid a false alarm.
- Do not inflate the cuff while loose.
- The cuff must not be applied to a limb that is required for an intravascular canula.
- The hose length must not be changed. Only use the original Dräger hose material.

Limitations of the measuring method

The oscillometric method used here is based on measuring the change of pressure in an inflated cuff due to blood streaming through a partly occluded artery.

This means that the change in pressure must be sufficiently large for measurement to be reliable, and it must also be exclusively due to pulsation in the artery!

Unreliable results or no results at all are therefore to be expected in the following cases:

- Patients in a state of severe shock (low blood and pulse pressure with vasoconstriction).
- Patients whose blood pressure changes rapidly and considerably during the measurement.
- Patients with arrhythmias. Arrhythmias can have an adverse effect on measurement if the pressure pulses per heart beat vary considerably. Such changes in oscillation may also be due to spontaneous breathing/assisted ventilation, hypovolaemia or talking.
- Patients with conically shaped arms (choose a different site, e.g. the forearm or ankle).

Parameter box

Non-invasive blood pressure measurement (NiBP)

- Patients with sclerotic arteries.
- Patients who are moving violently or trembling (try to stabilise the limb).

Starting monitoring

The main operating steps can be undertaken at the parameter box or on the monitor.

- 1 Plug the hose connectors into the parameter box. For easier insertion, the rubber rings of the connectors can be moistened slightly.
- Apply the appropriate cuff to the patient and connect it to the hose. Make sure that all connections are tight. Even slight leaks make measurement impossible.

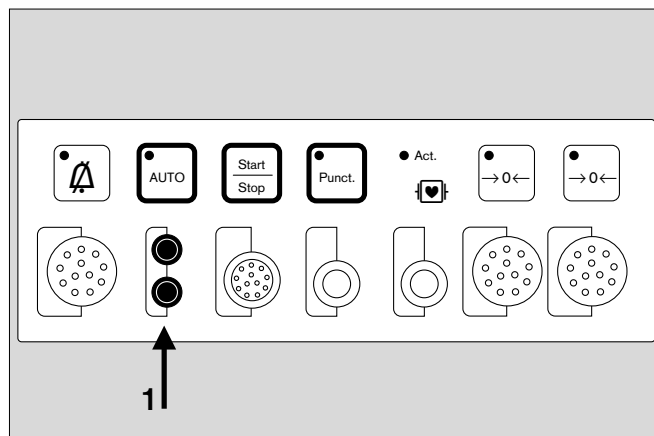

Manual measurement

- 2 Press .

The cuff is inflated and the cuff pressure indicated constantly in the bar graph on the monitor module.

- 3 The systolic, diastolic and
- 4 mean pressure are displayed when the measurement is complete.

Incorrect measurements are repeated 5 seconds after releasing the air. A third and last attempt is made after 30 seconds if the second measurement also proves incorrect.

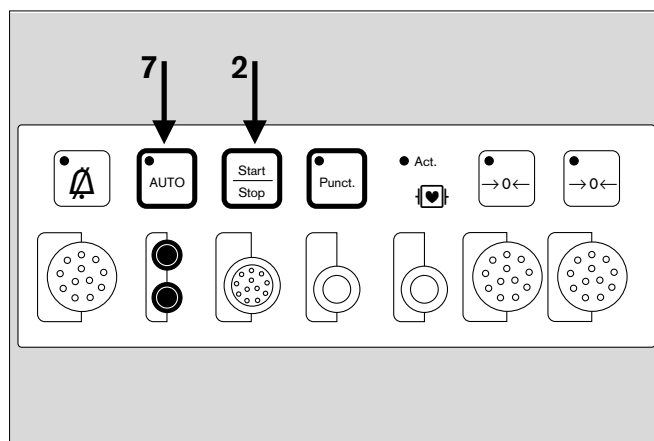

Automatic measurement

- 5 A time bar indicates the relative time elapsed between two automatic measurements. The actual cuff pressure is indicated here during measurement.

- 6 Time interval for automatic measurement.

- 7 Press .

The LED in the key lights up, and automatic measurement starts. NiBP measurements are performed by the parameter box at the set time interval.

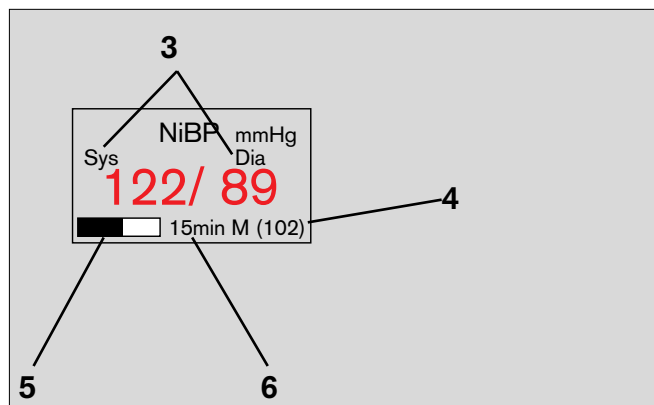

To interrupt measurement

- 2 Press .

to interrupt measurement. The air is immediately expelled from the cuff.

Adjusting settings

- Press the softkey »Parameter«.
- Move the cursor frame to »NiBP« with the rotary control and press to confirm.

The menu for setting the measurement parameters is displayed.

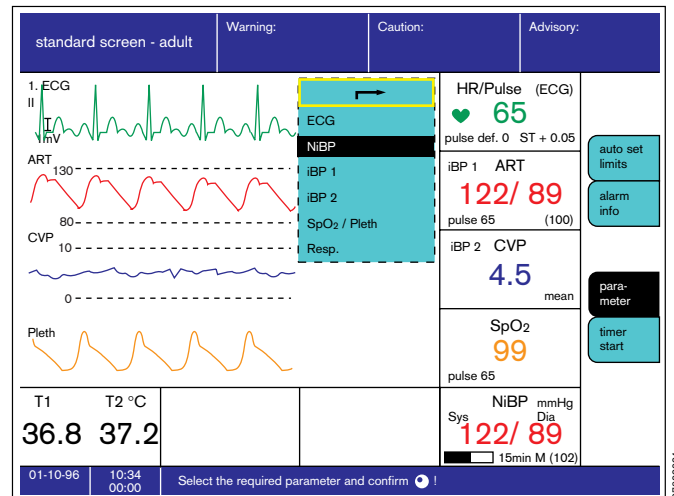

Auto on / off
Activates automatic measurements at the specified time intervals.

punction start / stop
Starts and stops the inflation process for constricting the venous blood flow. The pressure is released automatically after 2 minutes.

measurement Start / Stop / Turbo

»Start«
Starts a manual measurement outside the automatic time interval.

»Stop«
Ends a measurement.
Or press on the parameter box.

»Turbo«
Five simplified measurements in five minutes.
Can also be interrupted immediately by »Stop«.

time interval 2 / 3 / 5 / 10 / 15 / 20 / 30 / 60
Selects the time interval for automatic measurement in minutes. A manually triggered measurement between two automatic measurements does not affect the starting time for the next automatic measurement.

active alarms sys / dia
Determines whether the systolic or diastolic pressure is to be monitored.

initial pressure numerical
(separate for adults and neonates)
Sets the initial inflation pressure for the measurement.

punction pressure numerical
(separate for adults and neonates)
Sets the punction pressure in the cuff.
Change by turning the rotary control. Confirm the new value by pressing the control.

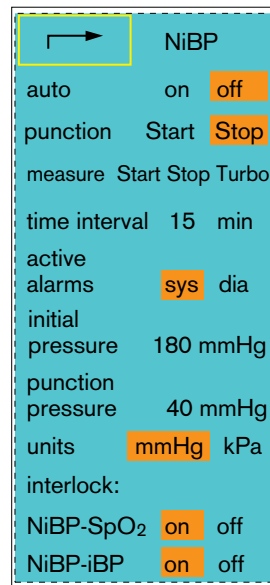

Parameter box

Non-invasive blood pressure measurement (NiBP)

Unit **mmHg / kPa**
 Switches over between pressure measuring units »mmHg« and »kPa«.

Interlock
NiBP-SpO₂ **auto / off**
 Activates and deactivates the interlock function between »NiBP« and »SpO₂«.

When interlock is switched on and the NiBP cuff is inflated, the SpO₂ pulse alarm is deactivated in order to prevent false alarms if both measurements are taken on the same arm.

Interlock
NiBP-iBP **auto / off**
 Activates and deactivates the interlock function between »NiBP« and »iBP«. The »iBP pulse« alarm is suppressed while the cuff is inflated.

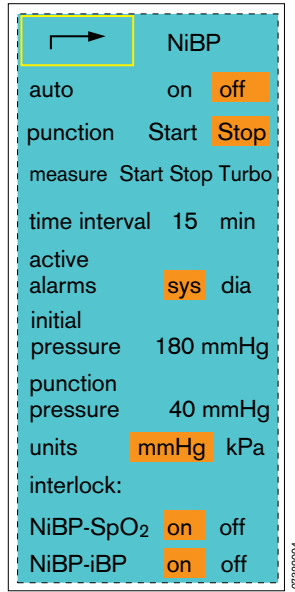

NiBP-alarms:

If an invasive arterial pressure is measured, the NiBP alarms are suppressed.

If an NiBP alarm is triggered, you can suppress the alarm sound until the next NiBP measurement by pressing .

A simple test can be called up in the configuration menu to check the NiBP measurement. When the cuff is at zero pressure, the display must indicate »0 mmHg«.

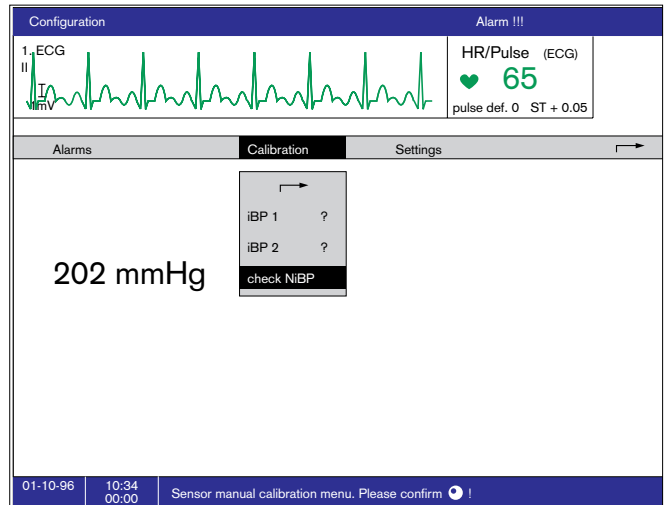

Measuring the blood pressure of neonates

The parameter box contains special algorithms in neonatal mode for monitoring neonates.

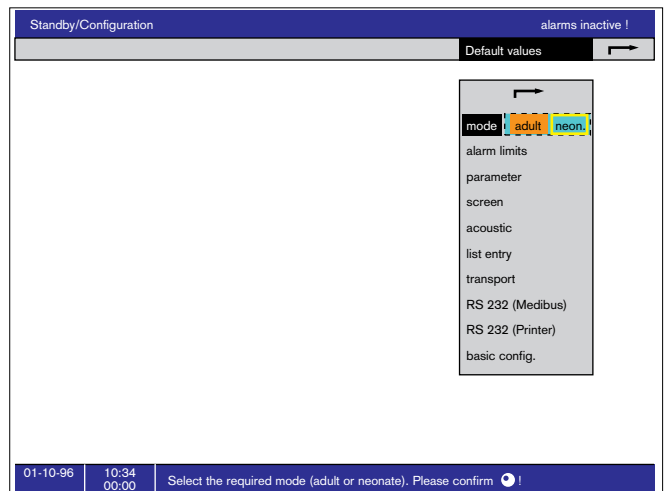

Invasive blood pressure (iBP)

Starting the monitoring of invasive blood pressure

The settings and functions of the channels are identical and are therefore described only once below.

- For intracranial and intracardial operations, an earthing cable must first be connected for equipotential bonding between the ground stud on the back of the device (marked ∇) and the ground connection in the operating theatre.
- Select the pressure transducer type in the standby configuration menu (see page 25 »iBP channels«).
- Connect the pressure transducer to the parameter box (colour-coded grey).
- Connect the infusion system and catheter/canula to the transducer. Eliminate any air bubbles in the catheter/transducer system, as they can impair measurement.
- Apply the pressure transducer level with the heart.
- If necessary, wait until the pressure transducer has warmed up.
- Connect the transducer dome to the catheter/infusion system, and open it to atmospheric pressure.

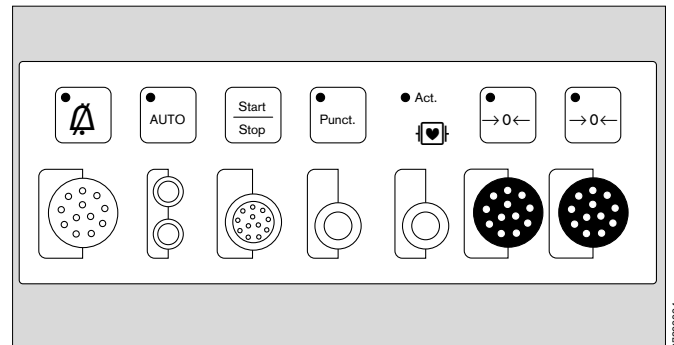

Calibrating the sensors

- Press the »parameter« softkey.
- Move the cursor frame to »iBP 1« or »iBP 2« by turning the rotary control, and confirm by pressing the control.
- Move the cursor frame to »calibrate« by turning the rotary control, and confirm by pressing the control. The system then enquires whether the sensor has been exposed to atmospheric pressure.
- Open the transducer dome and confirm by pressing the rotary control.

The clock symbol \oplus appears during the calibration process. A tick (✓) then appears behind the function.

- Close the transducer dome and reopen the connection to the catheter/infusion system; the pressure trace and pressure values are displayed.

Or on the parameter box:

- Press the zero alignment key $\rightarrow 0 \leftarrow$ of the corresponding sensor **twice**; a tick (✓) appears behind the menu item on the monitor.

If a fault occurs during zero alignment, a question mark (?) appears after the menu item. The message »CAL?« is displayed instead of the measured values, or the LED in the $\rightarrow 0 \leftarrow$ key flashes.

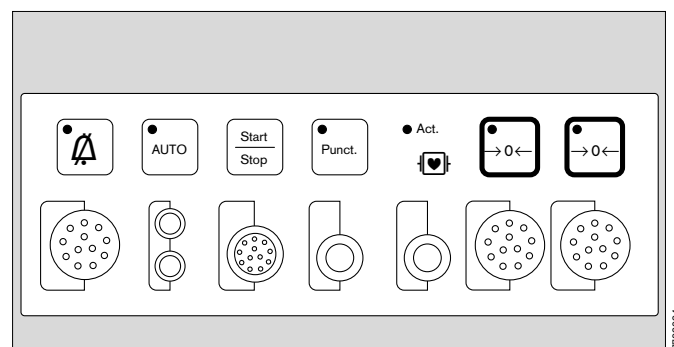
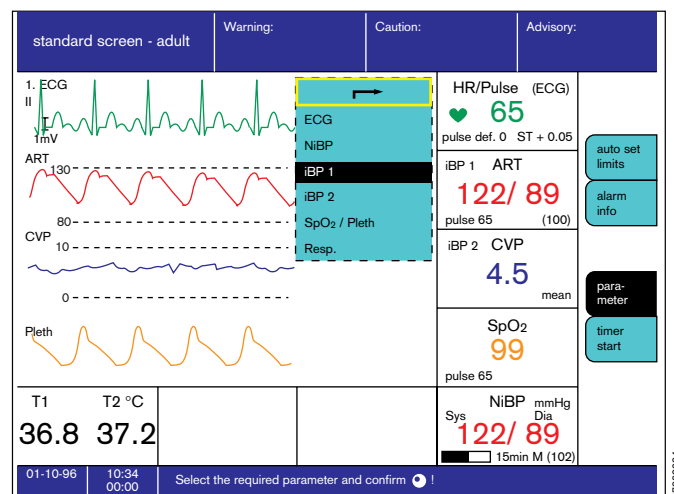

Changing settings

- Press the »parameter« softkey.
- Move the cursor frame to »iBP« by turning the rotary control, and press to confirm.

The menu for setting the parameters is displayed.

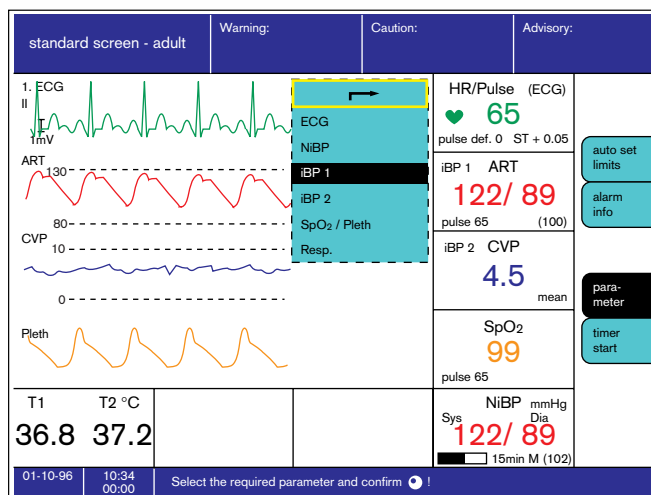

Setting functions

function on / off
Activates and deactivates the iBP measuring function.

site The names of the catheter sites are programmed in combination with the suitable curve amplitude, the display arrangement for systolic, diastolic and/or mean pressure, the alarm limits and the filter function.

The functions are automatically activated on selecting a site designation. The same designation cannot be used for both iBP 1 and iBP 2.

- ART** Arterial
- Aorta** Aorta
- A.Pulm** Pulmonary artery
- CVP** Central venous pressure
- ICP** Intracranial pressure
- ?** any other site

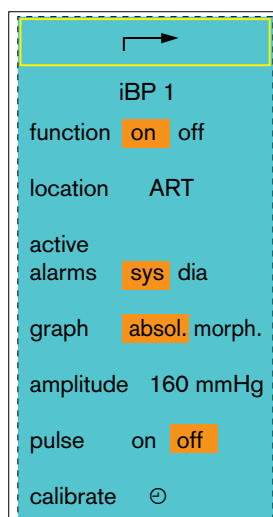

active alarms sys / dia

Selects whether the systolic »sys« or diastolic »dia« is used for monitoring.

graph abs / morph

Selects the type of graph.

– absolute graph, with reference to the zero pressure (= value of the bottom reference line). The scale of the upper reference line can be varied.

or

– morphological curve. This graph is automatically adjusted to the full height (amplitude) of the trace. With this method, manual scale adjustment is not possible.

- amplitude** Determines the magnitude of the absolute pressure graph on the screen. The preselected amplitudes depend on the measuring site.
- pulse on / off** Activates and deactivates pulse indication in the iBP module.
- calibrate** Zero calibration of the pressure transducer.
During calibration, the clock symbol (⌚) is displayed.

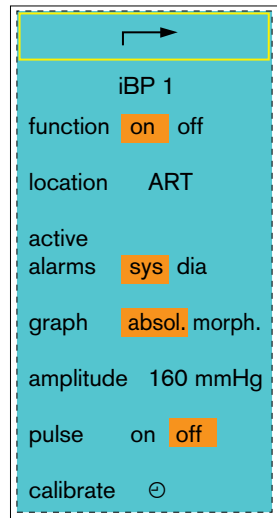

iBP Display

A pressure curve appears (example):

- 1 Absolute graph, with reference to the zero pressure (= value of the bottom reference line).

The scale of the upper reference line can be varied.

or

- morphological graph.

The graph is automatically adjusted to the full height (amplitude) of the trace. Manual amplitude adjustment is not possible in this mode.

If the double iBP module is configured, a pressure curve is displayed for each measuring channel.

Automatic scaling:

After calibration or after connecting the parameter box, the pressure curve is automatically calibrated.

In addition, the system displays the numerical values of the systolic/diastolic and mean pressure (mean pressure in brackets), except for ICP and CVP, in which cases the mean pressure only is displayed.

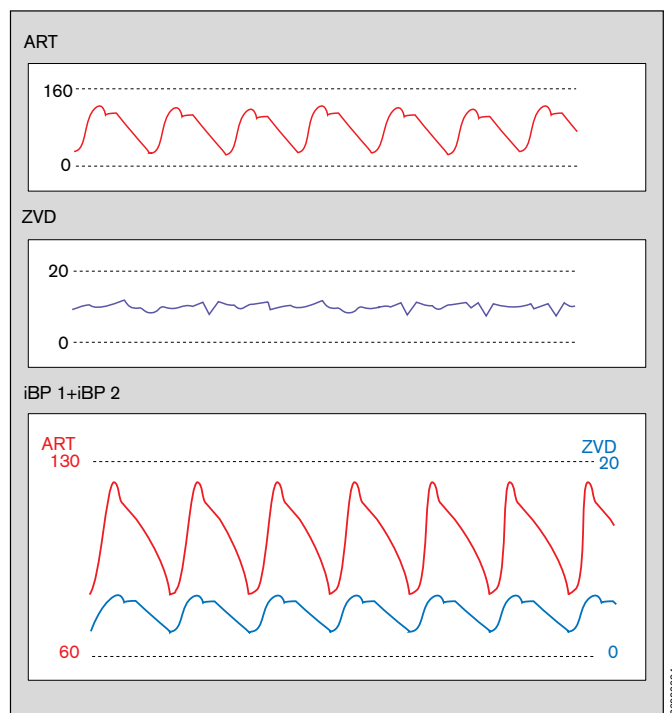

iBP 1 ART mmHg 122/ 89 Puls 65 (100)	iBP 1 AORTA mmHg 122/ 89 Puls 65 (100)
iBP 1 iBP ? mmHg 122/ 89 Puls 65 (100)	iBP 1 A.Pulm mmHg 122/ 89 Puls 65 (100)
iBP 2 ZVD mmHg 4.5 mean	iBP 2 ICP mmHg 4.5 mean

Functional oxygen saturation (SpO₂)

SpO₂ Display

- 1 Presentation of the plethysmogram.
- 2 Numerical presentation of the saturation value and pulse rate.

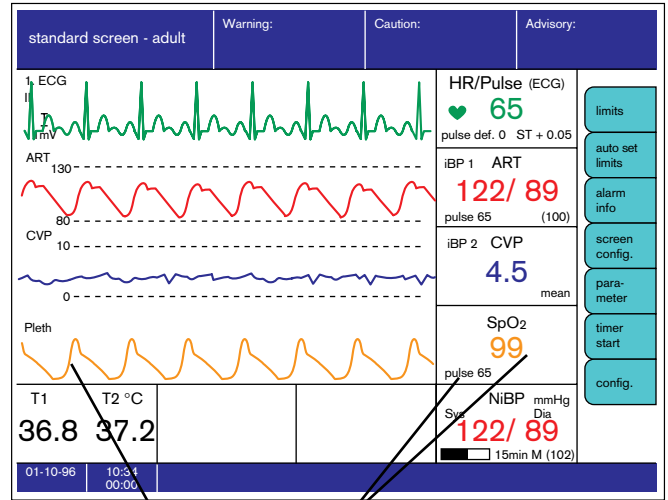

1

2

Changing settings

- Press the softkey »parameter« on the monitor.
- Move the cursor frame to »SpO₂ / Pleth.« with the rotary control and press to confirm.

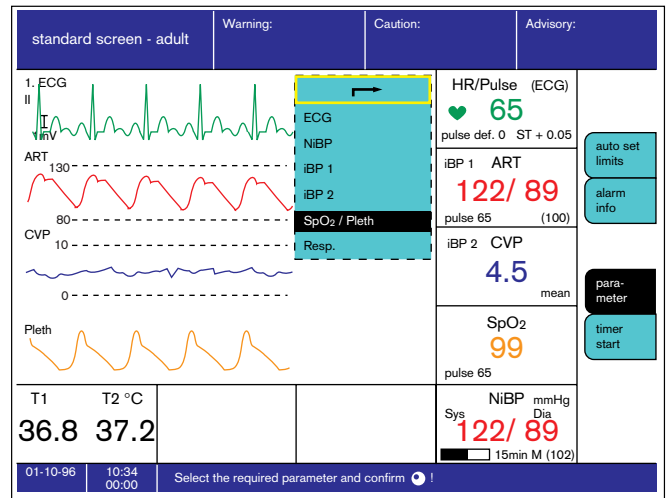

The menu for setting the measurement parameters is displayed.

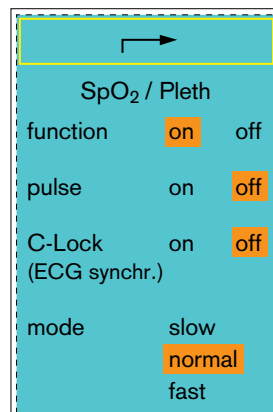

Setting functions

- function** **on / off**
Activates and deactivates the measuring function.
- pulse** **on / off**
Activates and deactivates indication of the pulse rate.
- C-Lock** **auto / off (ECG synchr.)**
Activates and deactivates automatic C-Lock synchronisation. C-Lock synchronises saturation measurement with the ECG. (The ECG pulse triggers SpO₂ measurement). This synchronisation leads to better measurement results if the patient moves or perfusion is poor.
- mode** **slow / normal / fast**
changes the speed of measurement.
- slow mode:** The measured value responds slowly to changes in oxygen saturation. Patient movement has little or no effect.
- normal mode:** The mode for normal conditions with relatively quiet patients.
- fast mode:** This mode should be used whenever rapid reactions are required and patient movement is insignificant.

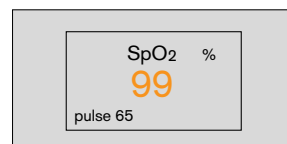
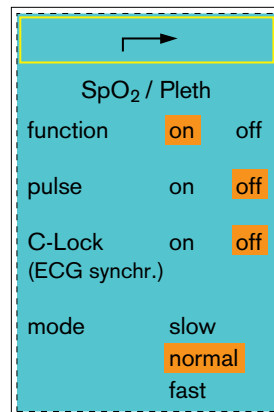

Safety and precautions

- For better results the sensor should not be applied to limbs together with an arterial catheter, infusion or sphygmomanometer cuff.
- Blood circulation must not be impeded during application of the sensor. If possible the measuring site should be changed from time to time, in order to avoid pressure necroses at the measuring point.
- Protect the sensor from bright light (cover the sensor).
- Only use Nellcor sensors, and apply them as described below.
- Damaged sensors must not be used.
- The adhesive strip of the oxiband sensor must be discarded after use. Do not stretch it unduly. Never use two strips together.

Choice of sensor

Use only Nellcor sensors! Note the Instructions for Use of the sensors. Tissue damage may be caused if they are positioned or used incorrectly.

The choice of sensor should be based on the following criteria:

- Weight of patient
- Mobility of patient
- Possible application site
- Perfusion of patient
- Period of use

The following table, listing the various sensors available and their specific characteristics, may prove useful here.

Type of sensor	OXISENSOR I-20	OXISENSOR D-20	DURASENSOR DS-100A	OXISENSOR D-25	OXISENSOR R-15
Age group	Infants	Children	Adults	Adults	Adults
Weight of patient	1 to 20 kg	10 to 50 kg	> 40 kg	> 30 kg	> 50 kg
Period of use	Short and long-term monitoring	Short and long-term monitoring	Short-term monitoring	Short and long-term monitoring	Short and long-term monitoring
Mobility of patient	limited activity	limited activity	inactive patients only	limited activity	inactive patients only
Preferred site	Toe	Finger	Finger	Finger	Nose
Sterility ¹⁾	in sterile packaging	in sterile packaging	—	in sterile packaging	in sterile packaging

1) in undamaged, unopened packaging

- Choose the appropriate sensor.

- 1 Plug the sensor into the socket of the adapter lead.
- 2 Press the flap down over the connector (strain relief and to prevent it being pulled out)
- 3 Plug the round connector of the adapter lead into the brown port on the parameter box.

Do not use an amplifier lead, because a preamplifier is already integrated in the parameterbox!

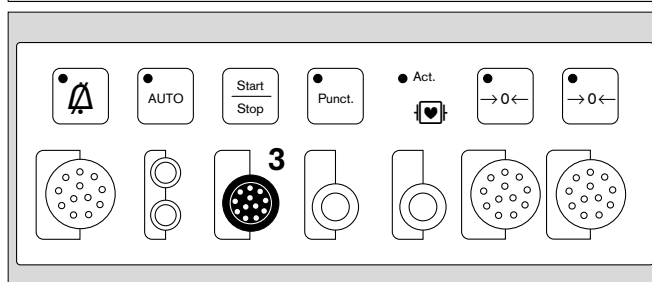
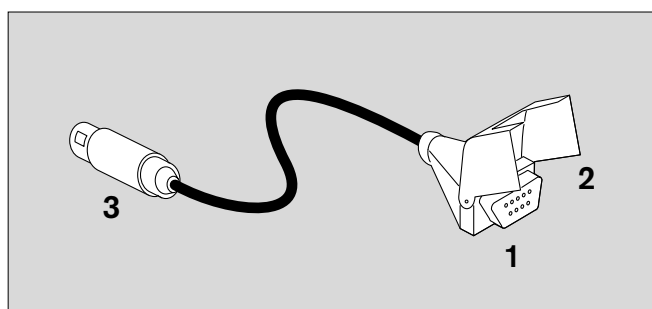

Tips to avoid artefacts

Nellcor sensors only must be used, and they must be correctly positioned to avoid the risk of measuring errors and tissue damage.

Damaged sensors with exposed electric wires or contacts must be withdrawn from use – danger of electric shock.

Adhesive strips must not be reused. They may not adhere properly. The adhesive strips must not be stretched unduly. Never use two adhesive strips together, as this may lead to venous pulsation and the failure of the pulse signal.

High intrathoracic pressure, pressure on the thorax and other consecutive impairments of the venous flow can lead to venous pulsation with failure of the pulse signal.

The pulse signal may fail in the presence of shock, low blood pressure, severe vasoconstriction, major anaemia, hypothermia, arterial occlusion proximal to the sensor and asystolia.

In the presence of bright light sources (e.g. surgical lamps and direct sunlight) the sensor must be covered, otherwise the pulse signal may fail or inaccurate results may be obtained.

The sensor should not be positioned on limbs together with an arterial catheter, sphygmomanometer cuff or intravascular venous infusion: the pulse signal may fail, and measurement becomes inaccurate.

Measurement accuracy may also be reduced in the event of significant concentrations of dyshaemoglobins, such as carboxyhaemoglobin or methaemoglobin, as well as of intravascular dyes, such as methylene blue.

Electrocautery can impair the measuring accuracy; the leads and sensor should therefore be positioned as far away as possible from the electrocautery and its neutral electrode.

Sensor performance may be impaired if the patient moves violently, thus leading to inaccurate results. The sensor should be applied to a different site in such cases in order to reduce the risk of artefacts due to movement.

Coupling with non-invasive pressure measurement

The "interlock" function should be activated if SpO₂ measurement and non-invasive blood pressure measurement are performed simultaneously on the same arm. The interlock function prevents false alarms being generated when the absence of a pulse is detected during NiBP measurement (see page 56).

Functional saturation compared with fractional saturation

Functional saturation is calculated as follows:

$$\% \text{ SpO}_2 (\text{func}) = \frac{100 \times \text{HbO}_2}{\text{HbO}_2 + \text{Hb}} \quad \%$$

Functional oxygen saturation is defined as the ratio of oxygen-laden haemoglobin to the total quantity of haemoglobin capable of transporting oxygen, expressed as a percentage.

Both oxygenated and reduced haemoglobin values are measured. Substantial amounts of dysfunctional haemoglobins, such as carboxyhaemoglobin and methaemoglobin, are disregarded. Fractional saturation can be measured in a variety of ways.

The percentage fractional saturation indicates the ratio of oxyhaemoglobin to total haemoglobin, regardless of whether or not the haemoglobin is available for oxygen transport. The measured dysfunctional haemoglobin is included.

When comparing the results obtained by different module manufacturers, it is important to know which method of calculation has been used in each case. The functional saturation can be calculated from the fractional saturation as follows:

$$\text{Funct. Sat.} = \frac{\text{Fract. Sat.} \times 100}{100 - (\% \text{ CO-haemoglobin} + \% \text{ methaemoglobin})}$$

Comparing the measured saturation to the calculated saturation

The oxygen saturation calculated from the partial pressure of the arterial oxygen (PaO₂) may differ from the values actually measured. The reason may be that when calculating the blood gas value, parameters such as temperature, pH-value, PaCO₂, 2.3-DPG and foetal haemoglobin concentration were not corrected.

SpO₂ measurement

Measuring principle

The light absorption properties of oxygenated arterial blood (oxyhaemoglobin HbO₂) differ from those of unsaturated venous blood (reduced haemoglobin Hb).

O₂ saturation is a logarithmic function of the irradiated light intensity (Lambert-Beer's law).

The effect of dyshaemoglobins such as carbon monoxide haemoglobin HbCO and methaemoglobin MetHb is normally negligible.

Parameter box
Functional oxygen saturation (SpO₂)

The sensor comprises two light-emitting diodes which alternately emit infrared light and red light with a typical wavelength of 920 nm and 660 nm respectively. The radiation intensity is measured by a photodetector opposite the diodes. The sensor is positioned on a limb in which the arterial blood vessels can be irradiated, such as a finger, toe or the nose.

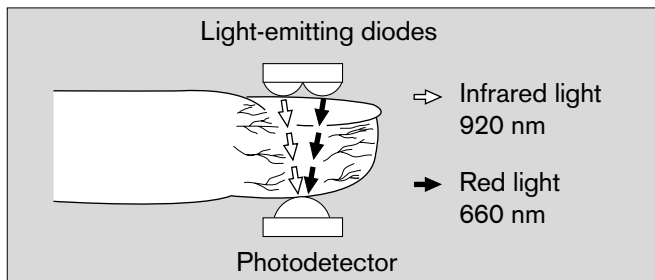

These two wavelengths (920 nm and 660 nm) have been chosen because, even in the presence of slight perfusion, they still provide meaningful absorption values for both oxygenated and reduced blood, while at the same time they differ significantly.

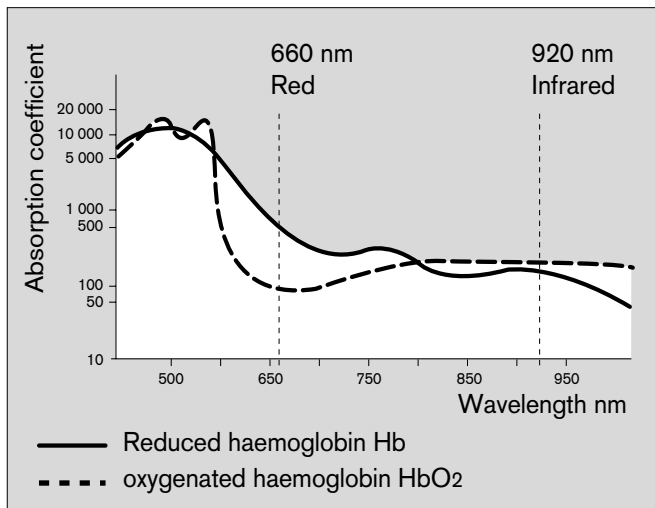

The light alternately emitted by the diodes is completely absorbed by the pulsating arterial blood, the skin, finger nails, muscular tissue, bones and venous blood.

Except for the pulsating arterial blood, the quantity and optical density of the light absorbed by the other components remains constant over a given unit of time.

By contrast, the arterial blood pulsating with every beat of the heart produces a change of tissue volume in synchronism with the pulse in the irradiated tissue, thereby causing a variation in the absorption of irradiated light in time with the pulse.

The light absorbed when there is no pulsating blood (during the diastole) is determined first. This measurement gives the amount of light absorbed by tissue and non-pulsating blood.

Normally, the absorption value does not change during the pulse phase and provides a reference value for the pulsating part of the absorption.

The absorption is then measured after the next heartbeat, when the blood flows into the tissue. For this measurement, the light absorption of both wavelengths changes, due to the pulsating arterial blood.

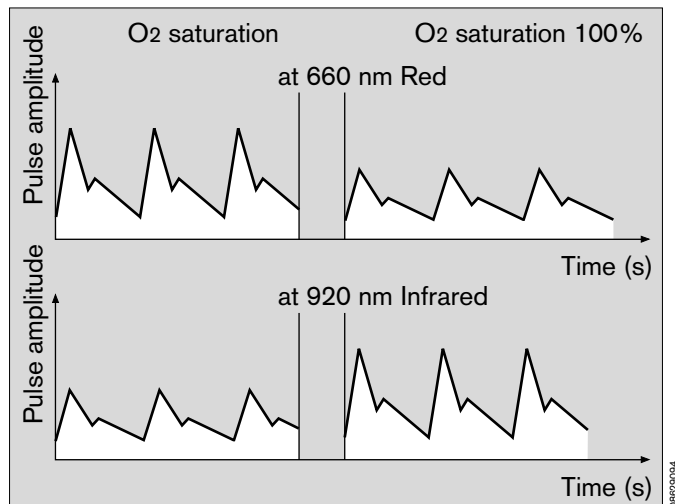

The graph above shows an example of the light absorbed by the blood at 660 nm (red) and 920 nm (infrared).

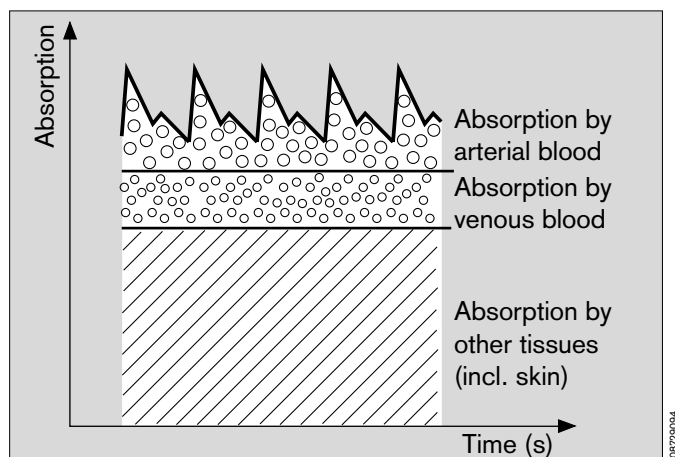

With increasing O₂ saturation, the absorption and corresponding pulse amplitude fall at 660 nm but rise at 920 nm. Since the absorption coefficients of HbO₂ and Hb are known for both wavelengths, the system can calculate the quantity of each of these two haemoglobins present. The quotient obtained by dividing the oxygenated haemoglobin (HbO₂) by the reduced and oxygenated haemoglobin (Hb+HbO₂) is termed the "functional saturation":

$$\% \text{ SpO}_2 (\text{func}) = 100 \times \frac{\text{HbO}_2}{\text{HbO}_2 + \text{Hb}}$$

This functional saturation refers only to the haemoglobin capable of transporting oxygen.

Dyshaemoglobins, HbCO and MetHb are normally negligible but may affect the accuracy of the measurement.

Temperature measurement

Starting measurement

- Use a protective sheath for rectal sensors.
- Apply the sensor(s) to the patient and connect to the parameter box (green colour code).
- The correct temperature values are displayed after about 3 minutes.

Display:

Temperatures T1 and T2 are displayed on the screen module.

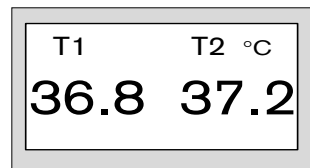

Measuring principle

Temperature-dependent change in the resistance of an NTC resistor (NTC = negative temperature coefficient) with linearisation circuit.

Respiration

Respiration is measured and monitored (rheographically) with the **red** and **yellow** ECG electrodes.

Respiration monitoring is not possible if the green ECG cable is used (HF interference suppressed).

Starting respiration monitoring

Respiration monitoring is activated as soon as ECG monitoring is started after switching on the Respiration function in the Parameters menu.

Respiration monitoring is switched OFF by default.

Cardiorespirogram

The Trend screen shows the trend curve of the cardiorespirogram (HR / RR).

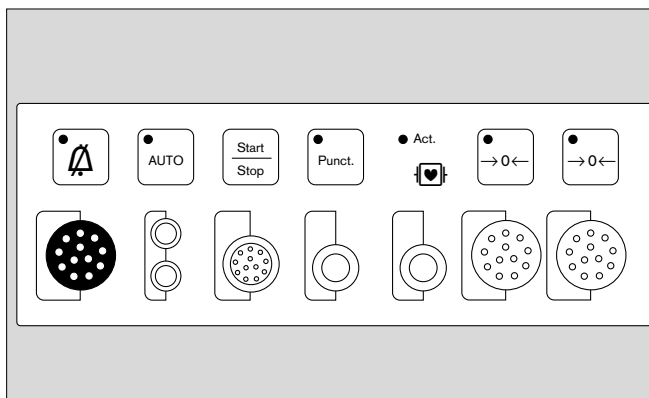

Changing settings

- Select the »Parameter« softkey.
- Move the cursor frame to »Resp.« with the rotary control and press to confirm.

The menu for setting the measurement parameters is then displayed:

function	on/off Switches the measuring function on/off.
mode	auto / man Automatic or manual adjustment of the recording level.
amplitude	1 / 2 / 4 / 8 / 16 / 32 Selects the scale of the respiration curve. The minimum size must correspond to the length of the displayed bar.
trigger	on/off Activates/deactivates the display of respiration recording pulses superimposed on the respiration curve (for checking that respiration is correctly recorded).
apnea	off / 10 / 15 / 20 / 30 Time interval in seconds after which an apnoea alarm is triggered in the absence of respiration measurement signal.

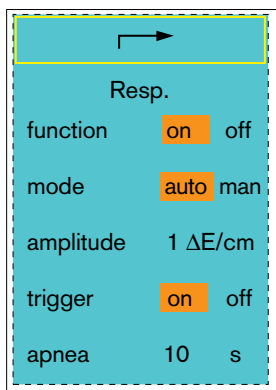

Applying electrodes

- Please refer to the relevant instructions in the section on »ECG/Heart rate«.

The best results are obtained when the electrodes of the **yellow** and **red** connections are applied as far as possible from each other on both sides of the thorax.

Respiration measurement

The breathing rate is calculated from the respiration curve (result of impedance variations in the thorax). Once the curve is recorded, it provides the basis for calculating the respiration rate per minute. Two different measurement methods are applied:

Automatic mode

The recorded level of the respiration curves is automatically adapted to the size of the curve. In this mode, slow-acting variations in curve size do not affect the calculation of the respiration rate. In general, this mode is preferred.

Adjustment of the recorded level to variations in curve size is a relatively slow process. Consequently, the system does not respond rapidly to changes in curve size, and no alarm can be emitted. Manual mode is therefore available for patients with a sporadically very flat respiration pattern.

Manual mode

A fixed level with a bar length (curve amplitude) of 10 mm is displayed on screen to help identify the respiration curve. All curves with a size of more than 10 mm are included in the respiration rate calculation.

Apnoea/coincidence alarm

The screen delivers an apnoea alarm if no respiration is detected during a predefined period of time. This period (duration of apnoea before the alarm is triggered) can be programmed in the parameter menu (off, 10, 15, 20 and 30 seconds).

The mechanical heart function can be superimposed on the respiration curve in the form of amplitude "excursions" (deflections). In the absence of any respiration, these pulsations could be misinterpreted as respiration curves. In this case, the respiration rate and heart rate would be considered roughly equal, and so an apnoea alarm would not be triggered.

The coincidence alarm, which indicates a suspected apnoea alarm, is triggered if the values of the recorded heart rate and respiration rate are identical, to within 5%, for a period of at least 5 seconds, and if respiration is

weak (curve amplitude less than 1 ΔE) and the heart rate is faster than 30 beats/minute. The coincidence alarm is only active in automatic mode.

It is possible that the heart rate and respiration rate are genuinely identical and that for this reason the coincidence alarm, as possible apnoea indication, is a false alarm.

To prevent constantly repeated coincidence alarms in these cases,

- select manual mode

or:

- reposition the electrodes of the red and yellow cable connections for a strong respiration signal (larger curve with the same amplitude setting).

Respiration monitoring in the operating theatre

Respiration monitoring is not possible if the shielded (HF-interference suppressed) ECG cable is used in the operating theatre to protect the patient and machine from interference caused by electrosurgery systems.

In this case, the respiration measurement function must be switched off in the parameter menu under »**Resp.**« in order to prevent false alarms.

Messages

The following messages can occur:

Apnea...s	Warning Displayed in the » Warning « field. Patient has apnoea. Also displayed complete with duration in seconds in place of the respiration value.
Coincidence...S	Warning Displayed in the » Warning « field. Coincidence of heart/respiration rate. Patient might have apnoea. Also displayed complete with duration in seconds in place of the respiration value. Can only be triggered when automatic measuring mode is activated.
Resp. Rate Lo	Warning Displayed in the » Warning « field. The respiration rate has fallen below the lower limit value.
Resp. Rate Hi	Warning Displayed in the » Warning « field. The respiration rate exceeds the upper limit value.

Troubleshooting

Contents

Where messages occur	74
Messages on the Monitor.....	75

Where messages occur

Warning, caution and advisory messages

These are the three types of message output by the system. They are classified in order of priority and listed alphabetically in the following tables (from page 69 onwards).

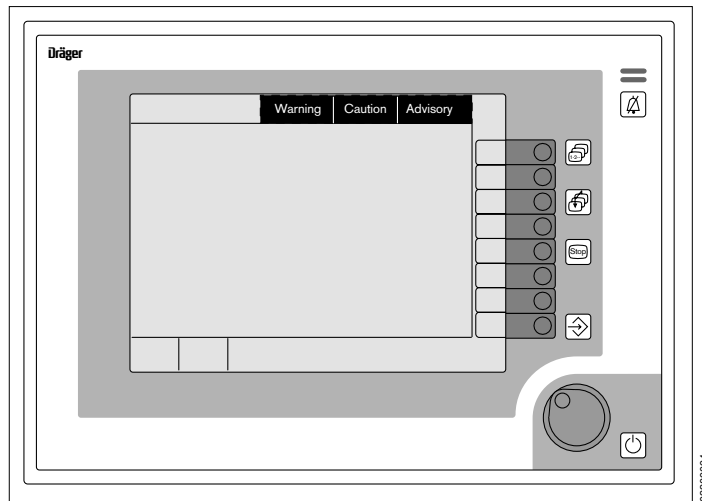

User prompts

appear in the bottom right-hand corner of the screen.

Display all alarms

- 1 Press the »alarm info« softkey.
The alarm texts of all active Warnings, Caution Messages and Advisory Messages are displayed in order of priority on the screen.

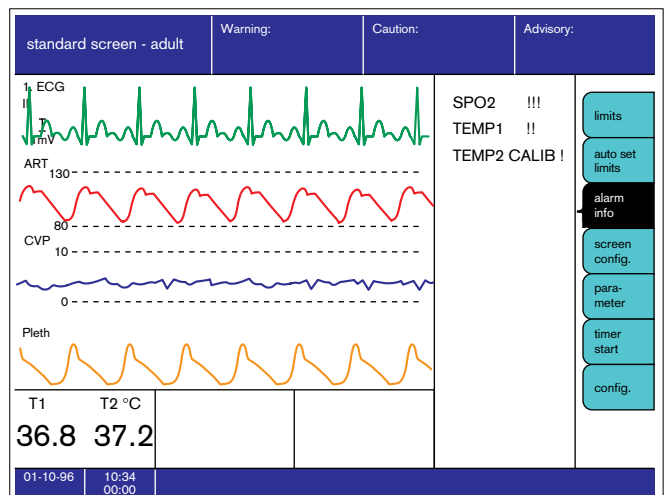

Messages on the monitor

(in alphabetical order).

Alarm messages are assigned to three priority classes (alarm priority) in the monitor of the PM 8060 vitara:

- **Warning** symbol »!!!« Text in red field
- **Caution** symbol »!!« Text in yellow field
- **Advisory** symbol »!« Text in white field

Always check the patient's condition first, before examining the machine for any possible measuring error!

Messages	Cause	Remedy
APNEA ECG !!!	Breathing/ventilation has stopped. No breath detected by rheographic measurement.	Check condition of patient.
ASYSTOLY !!!	No QRS waves have been detected in the ECG signal in the last 6 seconds.	Check condition of patient.
BP CUFF DISC !	Cuff hose disconnected? Leak in hose or cuff?	Check conditions. Replace cuff or hose.
BP CUFF ERR !	Cuff incorrectly positioned. Background interference. Highly irregular pulse?	Check cuff position. Do not touch cuff during measurement.
CAN COM ERR	Communication via CAN interface faulty.	Check connections of data lead. Inform Dräger Service.
CHECK iBP1 ! CHECK iBP2 !	No pulse detected during pressure measurement.	Check transducer and replace if necessary.
COINCIDENCE !	Respiration rate and heart rate are approximately equal.	Check condition of patient.
COOLING 8060? !	Temperature inside machine too high.	Inform Dräger Service.
DIAS iBP1 HI !! DIAS iBP2 HI !!	Diastolic pressure of the displayed channel (1 or 2) above the upper alarm limit.	Check condition of patient. Correct alarm limit if necessary.
DIAS iBP1 LO !! DIAS iBP2 LO !!	Diastolic pressure of the displayed channel (1 or 2) below the lower alarm limit.	Check condition of patient. Correct alarm limit if necessary.
ECG ARTIFACT !	The ECG signal has been disturbed by extraneous factors. The heart rate display will be paused for 15 seconds and will then be deactivated if the interference continues after this period.	
ECG ELECTROD !	ECG electrodes disconnected for longer than 15 seconds.	Check condition of patient. Correct alarm limit if necessary.
ECG INTERFERENCE !	The ECG signal has been distorted by interference from electro-surgery. The heart rate display will be paused for 15 seconds and will then be deactivated if the interference continues after this period.	
ECG N ? ! (!!) ECG LA ? ! (!!) ECG LL ? ! (!!) ECG RA ? ! (!!) ECG V ? ! (!!)	ECG electrodes have fallen off.	Secure electrodes. (Can be configured by Dräger-Service to alarm level » Caution « with display »!!!«)

Messages	Cause	Remedy
ECG SMALL !	ECG amplitude too low.	Check electrodes.
HRT RATE HI !!	Heart rate exceeds the upper alarm limit.	Check condition of patient. Correct alarm limit if necessary.
HRT RATE LOW !!	Heart rate below the lower limit.	Check condition of patient. Correct alarm limit if necessary.
iBP1PULSE HI !! iBP2PULSE HI !!	The pulse measured during invasive measurement is above the upper alarm limit.	Check condition of patient.
iBP1PULSE LO !!! iBP2PULSE LO !!!	The pulse measured during invasive measurement is below the lower alarm limit.	Check condition of patient.
MEAN iBP1 HI !! MEAN iBP2 HI !!	Mean measured invasive blood pressure of the displayed channel (1 or 2) above the set upper alarm limit.	Check condition of patient. Correct alarm limit if necessary
MEAN iBP1 LO !! MEAN iBP2 LO !!	Mean measured invasive blood pressure of the displayed channel (1 or 2) below the set lower alarm limit.	Check condition of patient. Correct alarm limit if necessary
NiBP ALRM OFF !	NiBP alarms are deactivated.	
NiBP DIA HI !!	Measured non-invasive blood pressure above the upper alarm limit.	Check condition of patient. Correct alarm limit if necessary.
NiBP DIA LOW !!	Measured non-invasive blood pressure below the lower alarm limit.	Check condition of patient. Correct alarm limit if necessary.
NiBP ERR !	Internal electronic or pneumatic fault.	Note fault code and inform Dräger Service.
NiBP MOTIONS !	Movement artefacts detected during measurement.	Secure limb if necessary. Measurement repeated automatically.
NiBP SYS HI !!	In non-invasive measurement, the systolic blood pressure is above the upper alarm limit.	Check condition of patient. Correct alarm limit if necessary.
NiBP SYS LOW !!	In non-invasive measurement, the systolic blood pressure is below the lower alarm limit.	Check condition of patient. Correct alarm limit if necessary.
NIBP TUBE ?	Cuff hose kinked.	Straighten out hose.
NO iBP 1 PULS !!! NO iBP 2 PULS !!!	No pulse detected during invasive measurement.	Check condition of patient.
NO S-T !	S-T analysis not possible.	Check electrode position.
NO SPO2 PULS !!!	No pulse signal detected by SpO ₂ measurement for approx. 10 seconds.	Read off ECG. Check SpO ₂ sensor (fallen off? NiBP measurement on same arm?).

Messages	Cause	Remedy
P-BOX ALR OF !	The parameter box alarms are deactivated.	
PB 8800 COM ? !	Communication failure with parameter box 8800	Check cable connections.
RESP RATE HI !!	The measured respiration rate exceeds the upper alarm limit.	Check condition of patient. Correct alarm limit if necessary.
RESP RATE LO !!	The measured respiration rate is below the lower alarm limit.	Check condition of patient. Correct alarm limit if necessary.
RS232COM ERR !	RS 232 communication interrupted.	Check connection.
S-T MV \nearrow !!!	Magnitude of S-T segment exceeds the upper alarm limit.	Check condition of patient. Correct alarm limit if necessary.
SPEAKER FAIL !	No alarm sound. Speaker defective.	Inform Dräger Service.
SPO2 ALRM OF !	The SpO ₂ alarm is deactivated.	
SPO2 ERR !	SpO ₂ measurement faulty.	Inform Dräger Service.
SPO2 HIGH !!	Oxygen saturation exceeds the upper alarm limit.	Check the O ₂ concentration in the fresh gas. Check ventilation.
SPO2 LOW !!!	Oxygen saturation below the lower alarm limit.	Check ventilation. Check the O ₂ concentration in the fresh gas.
SPO2 PULS HI !!	The pulse rate exceeds the upper alarm limit.	Check condition of patient. Correct alarm limit if necessary.
SPO2 PULS LO !!!	The pulse rate has dropped below the lower alarm limit.	Check condition of patient.
SPO2SEN DISC !	No pulse detected by the pulsoxymeter, even though the heart is clearly beating.	Check condition of patient (disturbed circulation?). Check that SpO ₂ sensor is correctly seated.
SYS iBP1 HI !! SYS iBP2 HI !!	In invasive measurement, the systolic blood pressure of the displayed channel (1 or 2) is above the upper alarm limit.	Check condition of patient. Correct alarm limit if necessary.
SYS iBP1 LOW !! SYS iBP2 LOW !!	In invasive measurement, the systolic blood pressure of the displayed channel (1 or 2) is below the lower alarm limit.	Check condition of patient. Correct alarm limit if necessary.
TEMP 1 HIGH !! TEMP 2 HIGH !!	Measured body temperature of the displayed channel (1 or 2) is above the upper alarm limit.	Check condition of patient. Correct alarm limit if necessary.
TEMP 1 INOP ! TEMP 2 INOP !	Temperature measuring function defective.	Replace temperature sensor. Inform Dräger Service.

Messages	Cause	Remedy
TEMP 1 LOW !! TEMP 2 LOW !!	Measured body temperature of the displayed channel (1 or 2) is below the lower alarm limit.	Check condition of patient. Correct alarm limit if necessary.
TEMP1 CALIB ! TEMP2 CALIB !	Fault found during the automatic internal accuracy test.	Inform DrägerService.
VENTR. FIBR. !!!	Ventricular fibrillation detected for longer than 3 seconds.	Check condition of patient.

Care

Contents

Stripping down the machine.....	80
Cleaning/disinfecting.....	80
Active agents and methods	80
Disposing of disposable articles.....	80
Wipe-cleaning.....	80
Disinfecting with formaldehyde vapour.....	80
Preparing the accessories.....	81
Inspection intervals.....	82

Stripping down the machine

Disconnect the device from the power supply, either by switching off the anaesthetic unit or the power adapter of the PM 8060 vitara.

Cleaning/disinfecting

Cleaning/disinfecting the screen and parameter box

- Disconnect the power supply before cleaning.
- Wipe the screen and parameter box with a damp cloth and household liquid soap. Do not allow water or other liquids to enter the device.
- Disinfect by wiping with disinfectant.
- The disinfecting method must conform to the relevant regulations and recommendations.
- **Do not use corrosive detergents, scouring agents or solvents.**

Agents and methods for disinfecting, cleaning and sterilisation

Only products from the list of surface disinfectants should be used for disinfecting. To ensure material compatibility, products based on the following agents may be used:

- aldehydes,
- alcohols and
- quaternary ammonium products.

The following products are suitable:

- Bacilloform,
- Buraton 10F,
- Alhydex (Cidex),
- Gigasept,
- Liquidasept,
- Halamid,
- Savlon,
- Hybitan,
- Cetavlon
- Terralin.

Follow the manufacturer's instructions.

The following products are not suitable:

- phenols,
- halogen-releasing compounds,
- strong organic acids and
- oxygen-releasing compounds

Do not use Ivisol or Edisonite.

Users in the Federal Republic of Germany are advised to use disinfectants specified in the current list published by the German Society for Hygiene and Microbiology (DGHM). The DGHM list also specifies the active agent of each disinfectant.

Users in countries in which the DGHM list is not available are advised to use the agents mentioned above.

- **Do not expose the devices to gaseous disinfectants.**
- Spray-disinfecting is not recommended. If a room is disinfected with an atomiser, the devices must be carefully covered with a piece of plastic. The devices must be switched off at the power switch and allowed to cool down sufficiently.
- **Do not operate the devices in the presence of disinfectants that evaporate and form explosive mixtures. The vapour must have escaped before the devices are switched on again.**

Disposal of disposable articles

Disposable articles and articles with limited service life can be disposed of as household refuse, provided that they have been used with non-infectious patients.

Infectious waste must be disposed of in accordance with the applicable special regulations.

Wipe cleaning

Parts which can be wipe-cleaned are listed in the table page 82.

Use a disposable cloth moistened with disinfectant cleaner.

Note effective time – parts must only be wiped, not immersed – do not allow liquid to seep inside the machine!

Disinfection with formaldehyde vapour

The PM 8060 vitara and the parameter box must not be treated with formaldehyde vapour!

Care of accessories

(ECG) Cable

- Do not immerse connections in liquid.
- Wipe with a cloth dipped in glutaraldehyde liquid.
- Do not use phenol-based or alcohol-based disinfectants because they may damage the plastic material.

Invasive blood pressure sensors

- Follow the manufacturer's instructions.

Sphygmomanometer cuff

- Clean with mild soapsuds. The cuff can also be sterilised, e.g. with Glutarex, taking care to observe the manufacturer's instructions. Rinse the cuff thoroughly.
- Fully dry the cuff (about 15 hours at room temperature). Do not heat.
- Do not use alcohol or other solvents.
- Fully close the orifice of the hose before immersing the cuff. Avoid any ingress of liquid in the cuff. Do not use the cuff again in the event of liquid ingress.

SpO₂ sensors

- Do not dip sensor in liquids.

Cleaning:

- Release the sensor from the parameter box.
- Clean with mild soapsuds or with a wad of cotton-wool soaked in isopropyl alcohol (70 %).
- After cleaning, dry the sensor thoroughly before reusing.

Sterilisation:

- Sterilise in an ethylene oxide mixture at 45–50 °C. Observe the specified ventilating times.
- Do not autoclave the sensors.

Temperature probes

- Do not dip connector in liquids.

Cleaning:

- Clean with a soft cloth and domestic liquid soap.
- Hold the probe at the sensor end and wipe down to the connection. Do not pull the cable while cleaning.

Sterilisation:

- Sterilise in a non-corrosive solution (e.g. 70 % alcohol, 0.5 % chlorine hexidine and 29 % water)
- The probes can be briefly dipped in water.
- Gas sterilisation is possible in ethylene oxide.
- Do not autoclave the probe.

Summary of recommended methods:

Machine components:	Method:			
	Disinfecting by wiping or immersion	Cleaning with automatic cleaners	Steam sterilisation at 121 °C	at 134 °C
Monitor	Wipe	No	No	No
Parameter box	Wipe	No	No	No
Sensors: Temperature sensor (skin/rectal/oesophagus)	Yes	No	No	No
The following parts cannot be processed and prepared: SpO ₂ -Sensors				

Machine and machine parts must be cleaned and disinfected before starting any maintenance work and before returning to the manufacturer for repair.

The following work may only be undertaken by qualified experts!

Safety inspections	Every 6 months
Metrology inspections for NiBP and body temperature measurements in the parameter box	Every 2 years (see calibration sticker on parameter box)
3V lithium battery for data backup (screen)	Change every 3 years.
Other intervals:	
Inspection and service*	Every 6 months.

* According to DIN 31 051

- Inspection = examination of the actual condition
- Service = measures to maintain the specified condition
- Repair = measures to restore the specified condition
- Maintenance = inspection, service and repair

What's what

Contents

Operating elements and displays on the Monitor 84
Operating elements and indicators on the Parameter Box 85
Back panel 86
Dimensions..... 87

What's what

Operating elements and displays on the monitor

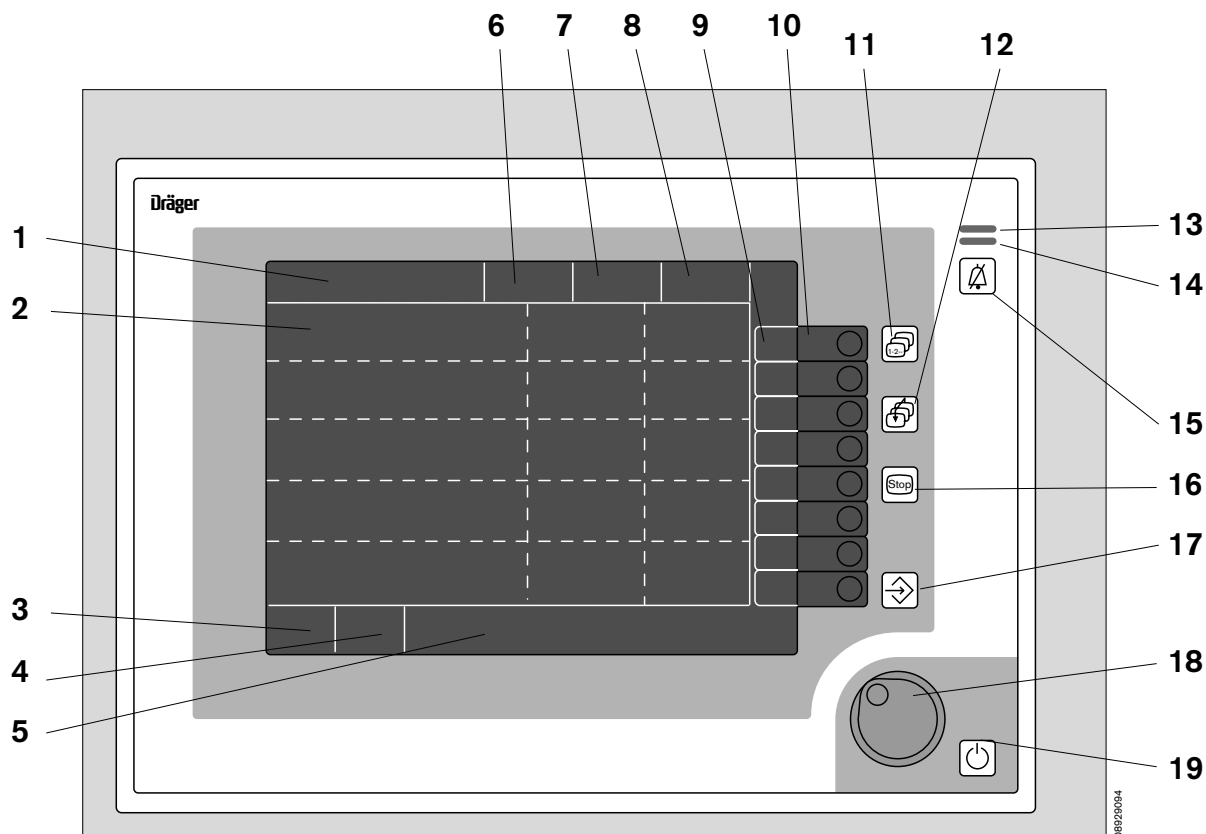

1 Status field with indication of alarm mode

2 Screen for graphs and measured values

3 Date field

4 Field for time and timer

5 User advisory field

6 Field for warning messages

7 Field for caution messages

8 Field for advisory messages

9 Designation of softkeys

10 Softkeys

11 Key for calling up preconfigured screens

12 Key for calling up the standard screen

13 Yellow LED for caution messages

14 Red LED for warning messages

15 Key for suppressing the acoustic alarm

16 Key for freezing displayed real-time curves

17 Key for manual list entry

18 Rotary control

19 Standby key

Operating elements and indicators on the parameterbox

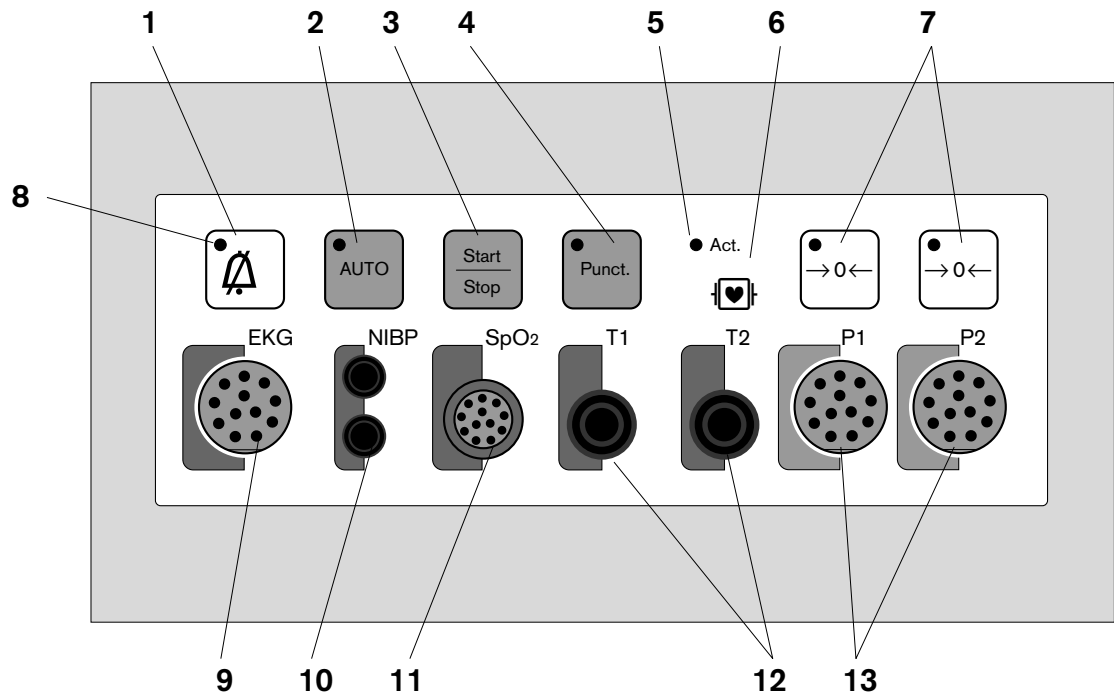

- 1 Key for suppressing acoustic alarm
- 2 Key for starting automatic NiBP measurement
- 3 Key for starting and stopping NiBP measurement
- 4 Key for starting inflation of the NiBP cuff
- 5 LED lights up when parameter box active
- 6 Symbol for intracardial application
- 7 Keys for zero alignment of each individual measuring channel for invasive blood pressure measurement (iBP)
- 8 LEDs in the keys light up when the corresponding function is active (in this case: acoustic alarm suppressed)
- 9 Socket for ECG electrodes, colour-coded red
- 10 Hose connectors for NiBP cuff, colour-coded purple
- 11 Socket for SpO₂ sensor, colour-coded brown
- 12 Sockets for temperature sensors, colour-coded green
- 13 Sockets for invasive blood pressure (iBP) measuring sensors, colour-coded grey

Back panel

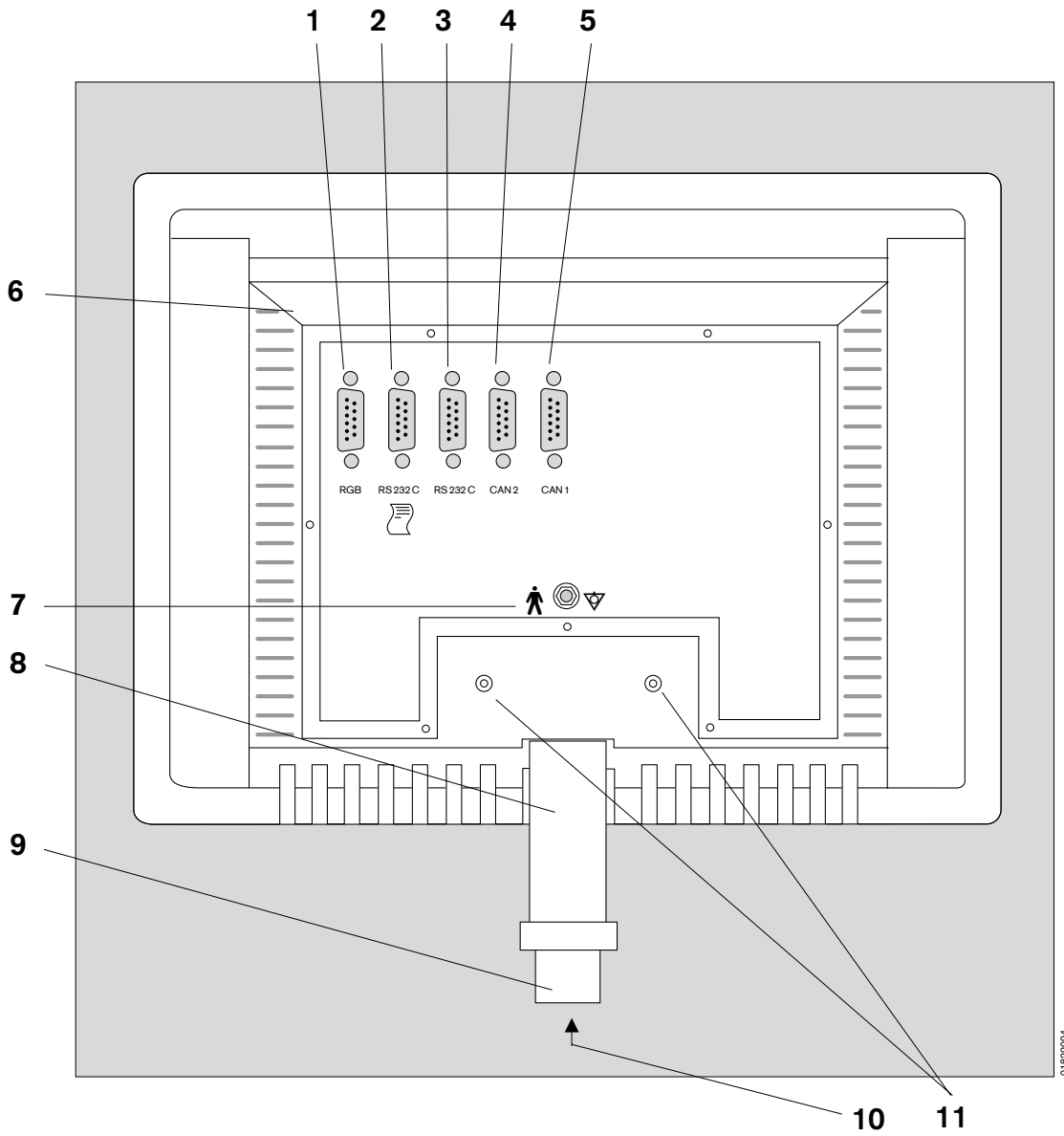

- 1 Connection for external RGB screen
- 2 RS 232 C Connection – serial printer port
- 3 RS 232 C Connection – serial MEDIBUS port
- 4 Connection 2 for CAN bus
- 5 Connection 1 for CAN bus
- 6 Ventilation slits. Do not block!
- 7 Ground stud for equipotential bonding
- 8 Mounting post
- 9 Fixing thread (M 20 x 2.5 - Allen screw, A/F 12 mm)
- 10 Adjustment of swivel resistance - Allen screw, A/F 5 mm
- 11 Adjustment of tilt resistance - Cross-slotted screw

Dimensions

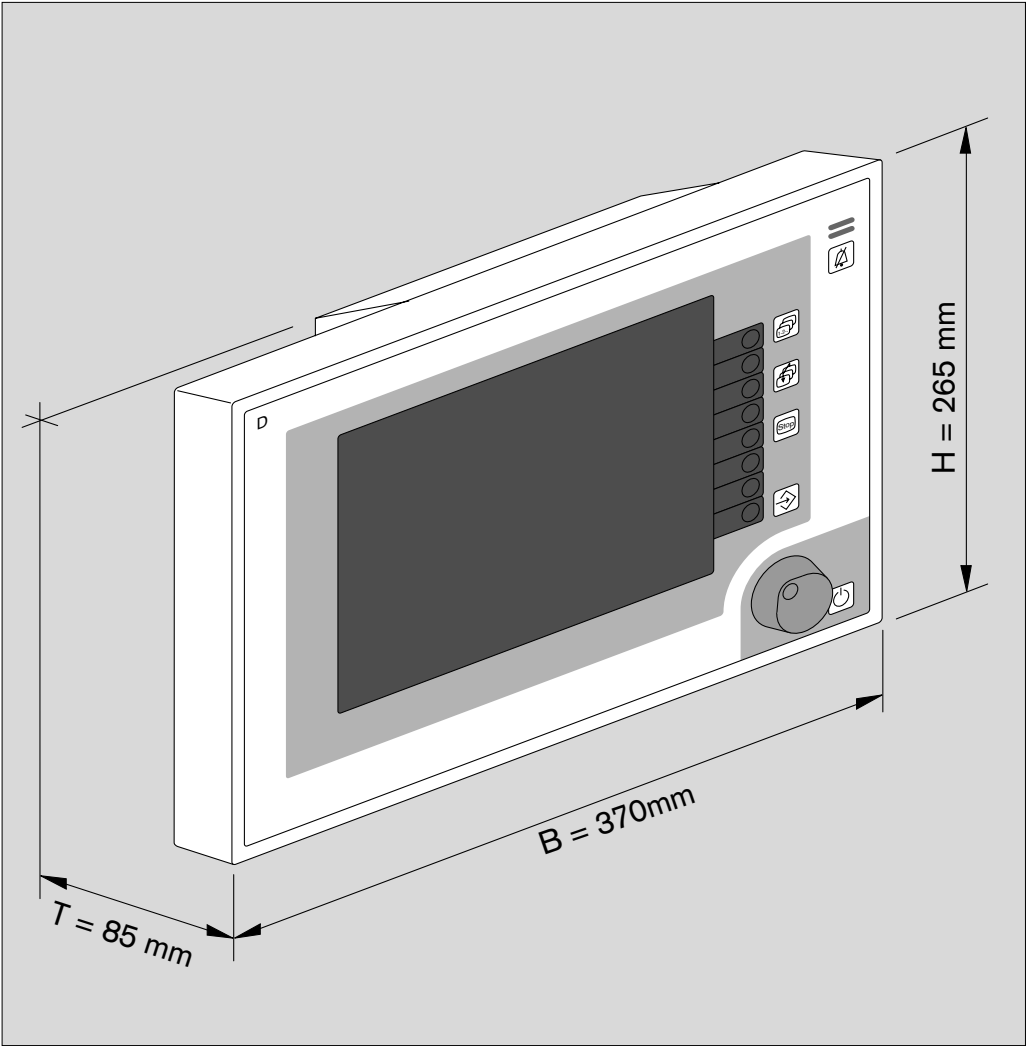

09125004

Technical data

Contents

Power supply	90
Ambient conditions	90
Data communication	91
Electrocardiogram	91
Heart rate	91
Non-invasive blood pressure (NiBP)	92
Invasive blood pressure (iBP)	93
Oxygen saturation	93
Body temperature measurement.....	94
Respiration.....	94
Transport function.....	95

Technical data

Where tolerances are given in percent and as absolute values, the higher value applies in each case!

Identification	The serial number of the PM 8060 vitara and the CE_{0023} symbol are located on the rating plate (nameplate) fixed to the back of the device. The device configuration and equipment level is coded in the appliance number and can therefore be identified.
Weight:	About 3.8 kg.
Dimensions	265 x 370 x 85 mm (H x W x D)
Electromagnetic compatibility (EMC)	Tested in conformity with EN 60601-1-2



Power supply for the PM 8060 vitara

Operating voltage	19 to 26 VDC
Current consumption	Max. 1.5 A (2 A with parameter box)

Power adapter

Operating voltage	85 to 264 VAC, 45 to 65 HZ
Current consumption	0.33 A for 230 V input voltage

Equipment Protection Classes

PM 8060 vitara	 , Type B
Power Supply	Class 1,  , Type B
Parameter box PB 8800	 , Type CF, protected against defibrillation shocks

Environmental conditions

Temperature	0 to +40 °C	(operation)
	-20 to +60 °C	(storage/transport)
Relative humidity	20 to 90%, no condensation	(operation)
	10 to 90%, no condensation	(storage/transport)

Data communication

RS-232-C (MEDIBUS)

Socket 9-pole Sub D, isolation 500V
 Pin layout 2 ≙ TxD, 3 ≙ RxD, 5 ≙ Earth

Printer

Socket 9-pole Sub D, isolation 500V
 Pin layout 2 ≙ TxD, 3 ≙ RxD, 5 ≙ Earth

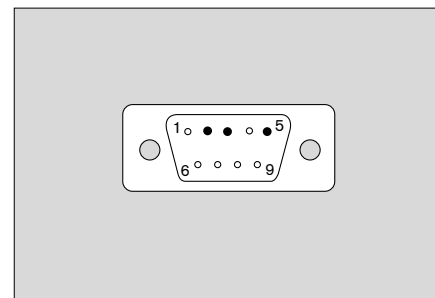

Electrocardiogram (ECG)

Input Isolated, IEC type CF; for ECG leads with 3, 4 or 5 electrodes; colour-coded red.
 Input impedance > 20 MΩ at 10 Hz
 > 4 MΩ at 40 Hz
 Leads 1, 2, 3 or I, II, III, aVR, aVL, aVF, V
 Display Position can be configured as required
 Input voltage max. 6 mV peak
 Graph display 0.25, 0.5, 1, 2, 4 mV/cm
 DC offset max. 300 mV (Filter set to »on«)
 Bandwidth 0.5 to 30 Hz (-3 dB; Filter set to »on«)
 0.05 to 70 Hz (-3 dB; Filter set to »off«)
 Interference suppression
 50/60 Hz with ECG lead and 5 kΩ unbalanced: > 127 dB
 Output impedance < 10 Ω, output current < 1 mA, short-circuit-proof.
 Noise < 25 μVpp with an impedance of 51 kΩ // 0.047 μF to each neutral line per electrode
 Zero stabilisation Automatic; when the mean peak value exceeds the display range.
 Stabilisation time < 0.5 s; artefact message and alarm after 15 seconds.
 Pacemaker pulses Automatically magnified on display when detection function active.
 Not counted in the majority of cases.
 Defibrillator Protected against defibrillation shocks; synchronisation pulse available.
 Socket receptacle, outer contact: ground
 Socket receptacle, inner contact: TTL output with 15 ms pulse duration
 Maximum retardation relative to R-wave: 26 ms
 Test specifications EN 601-2-27

Heart rate

Source of heart rate Derived from 1st ECG
 Heart beat indication Acoustic and visual; acoustic indication derived from SpO2 value
 (can be programmed).
 Frequency Average value measured over approx. 10 beats
 Measuring range 30 to 300 beats per minute
 Accuracy ± 2 beats/minute

Technical data

Pulse deficit indication	Difference between heart rate (derived from ECG) and pulse rate (derived from SpO ₂).		
Detection of asystolia/ ventricular flutter	Cannot be deactivated; asystolia alarm after 6 seconds; ventricular flutter detected after approx. 15 seconds; not available for children.		
S-T segment analysis	Amplitude	±3 mV,	
	Resolution	0.01 mV	
	Max. heartbeat	150 beats per minute	
	Lead (derivation)	Derived from the 1st ECG	
	Measuring point	40 ms after J point	

Non-invasive blood pressure (NiBP)

Input	Colour code: lilac. IEC Type CF		
Measuring method	Oscillometric		
Measuring range	Adult mode	20 to 290 mmHg	(3.0 to 38.6 kPa)
	Neonatal mode	5 to 150 mmHg	(0.6 to 20 kPa).
Accuracy	dynamic:	8 mm Hg	
	static	4 mm Hg	
Measuring unit	mmHg or kPa		
Cuff inflation	For the first measurement, the cuff is inflated to the maximum pressure preselected by the user (up to 180 mmHg for adults or 100 mmHg for adults); after reading off the systolic pressure, for the next measurement the cuff must be inflated to 20 mmHg above the last measured systolic value.		
	If the inflation pressure is too low for correct measurement of systolic pressure, air is automatically released from the cuff, and the measurement is repeated 5 seconds later with a higher cuff pressure. If this pressure is still too low, air is again released from the cuff, and the measurement is repeated 30 seconds later with increased cuff pressure.		
Release air from the cuff	<ul style="list-style-type: none">– On completion of the measurement.– When measurement is broken off by hand.– When the maximum measuring time is exceeded.– When the maximum cuff pressure is reached.– In the presence of undue artefacts.– In the event of a power failure / when switching off the monitor.– When NiBP function deactivated.		
Max. cuff pressure	300 mmHg	(40 kPa)	for adults
	150 mmHg	(20 kPa)	for neonates
Max. measuring time	90 seconds	for adults	
	60 seconds	for neonates	
Intervals for automatic measurement	every 2nd, 3rd, 5th, 10th, 15th, 20th, 30th and 60th minute. Manually triggered interim measurement does not affect the time between automatic measurements.		
Venous stasis	configurable between 10 and 100 mmHG.		
Test specifications	EN 60 601 - 2 - 30.		

Invasive blood pressure (iBP)

Input	Floating, IEC, type CF; colour-coded grey
Input sensitivity	42.5 and 50 $\mu\text{V/V}/10\text{ mmHg}$
Input impedance	90 k Ω (can be changed to 1 M Ω)
Bridge voltage	5 V DC
Bridge impedance	200 Ω to 10 k Ω
Zero alignment	Semi-automatic; not possible while pressure continues to fluctuate (with site label »Art« or »Aorta«); range $\pm 70\text{ mmHg}$. Inaccuracy < 0.5 mmHg.
Bandwidth	0 to 7 Hz (-3 dB)
Measuring ranges for graph display	5 to 320 mmHg in increments of 5 mmHg
Max. pressure signal	-10 to 320 mmHg for undistorted display
Measured parameters	Systolic, diastolic and mean pressure
Measuring range	-10 to 320 mmHg
Accuracy	0 to 40 mmHg: $\pm 1\text{ mmHg}$ >40 to 160 mmHg: $\pm 2\text{ mmHg}$ >160 mmHg: $\pm 4\text{ mmHg}$
Measuring unit	mmHg
Site labels	Art, Aorta, APul, CVP, ICP, ? (the question mark stands for the manually entered site label). A site label automatically controls the adjustment of the measuring range, alarm limits and display configuration for the relevant site.
Test specifications	EN 601-2-34

Oxygen saturation (SpO₂)

Input	Colour code: brown. Floating input, IEC Type CF
Cable type	no amplifier
Wavelengths	660 nm (red) and 920 nm (infrared)
Display refresh rate	After every pulse
Alarm limit	Adjustable from 50 % to 100 %
Measuring range	0 to 105 %
Accuracy	Adults: 0 to 50 % undefined 50 to 70 % $\pm 3\%$ 70 to 100 % $\pm 2\%$ Neonates: 0 to 70 % undefined 70 to 100 % $\pm 3\%$
Accuracy of Durasensor	$\pm 3\%$ (additional)
Measuring modes	Normal mode: measurement over 5 to 7 seconds Fast mode: 2 to 3 seconds Slow mode: 10 to 15 seconds Off: Module deactivated

Technical data

Plethysmogram	Automatic amplitude control, proportional to the pulse volume.
Pulse rate	Derived from plethysmogram; no pulse rate tone in slow mode. The pulse rate tone is controlled by the SpO ₂ measurement when programmed accordingly.
Measuring range (pulse)	20 to 250 beats/min
Accuracy (pulse)	± 2 beats/min
Test specifications	pr EN 865

Temperature measurement

Inputs	Floating, IEC type CF, colour-coded green.
Parameter	Two temperature values (T1, T2); both are monitored by alarm limits.
Measuring ranges	0 °C to 45 °C; resolution 0.1 °C
Accuracy	±0.1 °C
Self-test	A fault message is output when one of the automatically tested fault limits is exceeded.

Respiration measurement

Application	Adults and neonates
Input	ECG input, use of ECG electrodes
Method	Impedance measurement between yellow and red electrode connection
Measuring current	Approx. 90 µA, 125 kHz with patient impedance of 1 kΩ
Curve speed	6.25 mm/s
Frequency value	Respiration rate, calculated over approx. 5 breaths
Measuring range	0 to 150 breaths/minute
Accuracy	±5 % of measured value or ± 3 breaths per minute: the higher value applies.
Measuring method	Automatic level adjustment for identifying curve peaks, or manual adaptation of the curve to a fixed detection level of 10 mm.
Respiration data	Respiration rate, duration of apnoea in seconds
Apnoea detection	Off, 10, 15, 20 and 30 seconds apnoea times
Coincidence alarm	The coincidence alarm indicates suspected apnoea. It is triggered if the heart and respiration rates are identical to within 5%, while respiration is weak (curve smaller than 1 ΔE) and the heart rate is higher than 30 beats/min. The coincidence alarm is only active in automatic measuring mode.

Transport function

The transport function permits continuous uninterrupted logging even while the patient is being moved, for example between the bed, pre-op, operating theatre and post-op.

The haemodynamic parameters are stored in the parameter box PB 8800 exchanged between the parameter box and the connected PM 8060 Vitaro.

The following data can be communicated:

Parameter	Settings	Measured value for the list	Alarm limits
ECG	3, 4 or 5-core cable Selected lead (derivation) Amplitude Pacemaker on/off recognition function	Heart rate Pulse frequency	Upper and lower alarm limits Upper and lower alarm limits
NIBP	Function on/off Automatic on/off Interval (time) Cuff inflation pressure Automatic on/off	Systolic pressure Diastolic pressure Mean pressure	Upper and lower alarm limits Upper and lower alarm limits
iBP 1/2	Function on/off Zero point of pressure pick-up Sensitivity of pressure pick-up Curve amplitude Graph display absolute/morphological Catheter position Interlock with NIBP on/off	Systolic pressure Diastolic pressure Mean pressure	Upper and lower alarm limits Upper and lower alarm limits Upper and lower alarm limits
SpO ₂	Function on/off Mode C-Lock on/off Interlock with NIBP on/off	O ₂ saturation	Upper and lower alarm limits
Temp. 1/2	Function on/off	Temperature T1	Upper and lower alarm limits

continued on next page

Parameter	Settings	Measured value for the list	Alarm limits
Resp.	Function on/off Trigger mode (manual/automatic) Amplitude		Upper and lower alarm limit
General	Application mode Site name Start time of monitoring phase End time of monitoring phase Patient name	Storage times of day Storage marks	
Data transferred from the anaesthetic or ventilation machine			
Parameter	Measured value for the list	Alarm limit	
None	End-expiratory CO ₂ Inspiratory O ₂ Ventilation minute volume AMV Inspiratory anaesthetic gas concentration Airway peak pressure Peak Airway pressure level PEEP Compliance	None	

Description

Contents

Abbreviations and symbols.....	98
Index.....	101





















Abbreviation and symbols

Abbreviation	Meaning
A/F	Width across flats
Act.	"Activity" (LED in the parameter box)
AMV	Minute ventilation
BW	Body weight
CAL	Calibration has been performed
C-Lock	Cardio-Lock (ECG synchronised)
C _{pat}	Patient compliance
DGHM	German Society for Hygiene and Microbiology
et CO ₂	End-expiratory CO ₂ concentration
Fet Des.	End-expiratory desflurane concentration
Fet Enf.	End-expiratory enflurane concentration
Fet Hal.	End-expiratory halothane concentration
Fet Iso.	End-expiratory isoflurane concentration
Fet N ₂ O	End-expiratory N ₂ O concentration
Fet Sev.	End-expiratory sevoflurane concentration
Fi Des.	Inspiratory desflurane concentration
Fi Enf.	Inspiratory enflurane concentration
Fi Hal.	Inspiratory halothane concentration
Fi Iso.	Inspiratory isoflurane concentration
Fi Sev.	Inspiratory sevoflurane concentration
Fi N ₂ O	Inspiratory N ₂ O concentration
Fi O ₂	Inspiratory O ₂ concentration
Hb	Haemoglobin
HbCO	Carbon monoxide haemoglobin
HbO ₂	Oxyhaemoglobin
in CO ₂	Inspiratory CO ₂ concentration
INOP	Malfunction
IPPV	Automatic ventilation mode: intermittent positive pressure ventilation
LED	Light-emitting diode
Man./Spont.	Manual ventilation or spontaneous breathing
Mean	Mean pressure
NTC	Resistance-type temperature sensor with negative temperature coefficient

Abbreviation	Meaning
Off	Switched off, deactivated
ON	Switched on, activated
P _{aw}	Airway pressure
PC	Personal computer (IBM compatible)
P _{peak}	Actual measured peak pressure
P _{lat}	Plateau pressure
Pleth.	Plethysmogram
P _{mean}	Mean airway pressure
Power	Electricity supply
PEEP	Positive end-expiratory pressure
Resp.	Respiration
SIMV	Synchronised intermittent mandatory ventilation
SpO ₂	Functional O ₂ saturation

Description
Abbreviations and symbols

Symbol Meaning

	Pulse rate
	Lower alarm limit
	Upper alarm limit
	Alarm monitoring inactive
	Close menu, return to previous menu level
	Changeover switch for Standby and Measuring modes
	Cyclic activation of basic pages
	Display standard page
	Suppress acoustic alarm for 2 minutes
	Connection for equipotential bonding
	Protection class type B (DIN IEC 601)
	Protection class type BF (DIN IEC 601)
	Protection class CF, protected against defibrillation shock
	Request for calibration
	Action has been completed successfully
	Action in progress
	Warning message
	Caution message
	Advisory message
	Alarm limit deactivated

Index

Abbreviations	98	Dimensions	87
Accessories	4	Disposable articles, disposing of	80
Accessories, care	81	ECG settings, standby	24
Acoustic, Standby	31	ECG, adjusting settings	55
Active agents, cleaning and disinfecting	80	ECG, applying electrodes	54
Alarm concept	45	ECG, display	54
Alarm info, operation	42	ECG, ST segment analysis	56
Alarm limits, auto set	41	ECG, technical data	91
Alarm limits, blood pressure, monitoring	48	ECG/heart rate, parameter box	53
Alarm limits, pulse rate, monitoring	47	Environmental conditions, technical data	90
Alarm limits, standby	23	Field, black/white	22
Alarm priority	45	Field, orange	22
Alarm tone, deactivating	6	Formaldehyde	80
Alarms, linkage	47	Full trend, operation	39
Alarms, show all	46	Function keys, parameter box	50
Apnoea alarm, respiration	71	Graph modules	28
Arrow, return	22	Hardkeys	8
Basic configuration, standby	35	Heart rate, technical data	91
Blue holder, parameter box	51	Holder for OP table, parameter box	51
Care	79	Holder, blue, parameter box	17
Care of accessories	81	Holder, OP table, parameter box	17
Care of device	80	Holder, slot-in housing, parameter box	17
Cause, fault messages and remedy (troubleshooting)	73	iBP channels, standby	25
Coincidence alarm, respiration	71	iBP locations, standby	25
Configuring general settings, standby	31	iBP, calibrating sensors	61
Connecting, "Cato"	15	iBP, changing settings	62
Connecting, external devices	14	iBP, display	63
Connecting, "Julian"	15	iBP, setting functions	62
Connecting, system	14	iBP, starting monitoring	61
Connection with other electrical equipment	4	iBP, technical data	93
Controls, screen, user interface	8	Indicator lamps	10
Curve speed, configuring, standby	31	Indicators, parameter box	50
Data communication, technical data	91	Instructions for use, strictly follow	4
Data transfer, fully automatic, parameter box	52	Instructions for use, working with, general	2
Data transfer, parameter box	52	Intended use, medical	6
Data transfer, semi-automatic, parameter box	52	Interface, MEDIBUS, standby	34
Data, technical	89	Interface, printer, standby	34
Default values, changing	21	Keys with dedicated function (hardkeys)	8
Device, care	80	Keys with variable function (softkeys)	8
Device, cleaning/disinfecting	80		
Device, stripping	80		
Device, switching on	14		

Liability	4	Respiration, messages	72
Limits setting, operation	40	Respiration, standby	26
Linkage, alarms	47	Respiration, starting monitoring	70
List entry, standby	32	Return arrow	22
List intervals, parameter box	52	Rotary control	9
List screen, operation	37		
Maintenance	4	Safety, for your own and that of your patients	4
Menu structure	10	Screen background, configuring	30
Messages on the monitor	75	Screen colours, configuring	30
Messages, where they occur	74	Screen configuration, operation	42
Methods, cleaning and disinfecting	80	Screen functions	19
Mode, adults/neonates	22	Screen module, graph	28
		Screen module, numerical	29
NiBP settings, standby	24	Screen saver	11
NiBP, adjusting settings	59	Screen structure	10
NiBP, applying the sphygmomanometer cuff	56	Screen, configuring, operation	43
NiBP, interrupting measurement	58	Screen, configuring, standby	20
NiBP, limitations of measuring method	57	Screen, configuring, standby, calling up	20
NiBP, measuring blood pressure of neonates	60	Screen, configuring, temporary	20
NiBP, starting monitoring	58	Screen, starting up	35
NiBP, technical data	92	Show, all alarms	46
Numerical modules	29	Slot-in housing, parameter box	17
		Softkeys	8
Operating concept	7	SpO ₂ , changing settings	64
		SpO ₂ , choice of sensor	66
Pacemaker pulse detection, parameter box	53	SpO ₂ , coupling with NiBP	67
Parameter box	49	SpO ₂ , display	64
Parameter box, fitting	17	SpO ₂ , measuring principle	67
Parameter, operation	42	SpO ₂ , safety and precautions	65
Parameters, standby	23	SpO ₂ , setting functions	65
Patient alarms, auto setting	41	SpO ₂ , technical data	93
Patient safety	4	SpO ₂ , tips to avoid artefacts	67
Power supply, connecting	14	SpO ₂ /plethysmogram, standby	25
Power supply, technical data	90	Standard screen, operation	37
Precautions for use	6	Standard screens, configuring, standby	27
Preparation for use	13	Standard screens, configuring, standby	27
Protection classes, technical data	90	Suppressing, alarm tone	46
		Swivel arm, mounting	16
Remedy, fault messages and cause	73	Symbols	98
Respiration measurement, automatic	71		
Respiration measurement, manual	71	Technical data	89
Respiration measurement, technical data	94	Temperature measurement, display	69
Respiration monitoring in operating theatre	72	Temperature measurement, measuring principle	69
Respiration, applying electrodes	71	Temperature measurement, starting measurement	69
Respiration, cardiorespirogram	70	Temperature measurement, technical data	94
		Tilting, screen	16

Timer, operation	43
Transport function, parameter box	51
Transport function, standby	32
Transport function, technical data	95
Trend screen, operation	39
Troubleshooting	73
Turning and tilting, screen	16
What's what	83
What's what, back panel of monitor	86
What's what, dimensions	87
What's what, monitor	84
What's what, parameter box	85
White housing, parameter box	51
Wipe-cleaning	80
Z oom function, trend screen, operation	39

These Instructions for Use apply only to
PM 8060 vitara
with Serial No.:

If no Serial No. has been filled in by Dräger
these Instructions for Use are provided for
general information only and are not
intended for use with any specific
machine or device.



Directive 93/42/EEC
concerning Medical Devices

Dräger Medical AG & Co. KGaA

Germany

🏠 Moisinger Allee 53 – 55

D-23542 Lübeck

☎ +49 451 8 82 - 0

📠 26 80 70

FAX +49 451 8 82-20 80

🌐 <http://www.draeger.com>

90 29 095 - GA 6497.705 en

© Dräger Medical AG & Co. KGaA

3rd edition - July 2001

Subject to alteration