

Cardio-M Plus OPERATION MANUAL



CE0123

Warranty

- The warranty for this product runs for 2 years (for EU countries). But the warranty for accessories runs for 6 months.
- Warranty repair or replacement will be made by the Medical Econet GmbH Service Center at no charge for the warranty period, if properly used under normal conditions, in accordance with the instructions for use.
- In the event of a malfunction or failure during the warranty period, the customer should inform Medical Econet GmbH. of the model name, serial number, date of purchase and a description of the problem with the equipment.

Contact Medical Econet GmbH

Contact Us

If you have any questions or comments relating to our products or purchasing, please contact our office at the telephone number or e-mail address below. You can talk to our sales people. Medical Econet GmbH always welcomes your inquiries. Please contact us.

- Customer service → +49 (0) 2365 92437 0

⌘ When the product is not operating correctly, please contact our customer service center with the name of the model, serial number, and a description of the problem you are experiencing.

Technical assistance

Please contact this number for technical support.

- +49 (0) 2365 92437 15
- e-mail: service@medical-econet.com

Fee-Based Service

If you wish to make a claim when the product is damaged through misuse, we charge repair fees. Please read the manual before you make a claim.

1. The warranty does not cover cleaning, adjusting and instructions for use.

2. A fault of customer

When the product is damaged or broken due to customer's improper use or misuse.

- When the power cord is replaced improperly by the user.
- When the user drops the product while moving.
- When the user uses unauthorized accessories.
- When the product is repaired by an unauthorized person.

3. Others

- When the product is damaged by any external means; such as, but not limited to a natural disaster (fire, flood or earthquake).
- When warranty of main unit or accessories ends.

Definition of WARNING, CAUTIONS and NOTE

- In order to stress the contents of this manual, we define the terms below. Please follow the warning and caution instructions.
- The manufacturer or service agents are not responsible for the damage resulting from inappropriate use or carelessness.

WARNING

There may be serious injuries, fatal accidents or financial damages if you violate these instructions.

CAUTIONS







There may be slight injuries or reduced damages if you violate these instructions.

NOTE

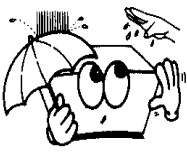
There may not be any dangerous events, but it is important to note this instruction for installation, use, maintenance or repair.

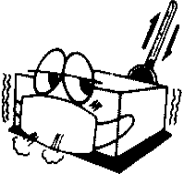
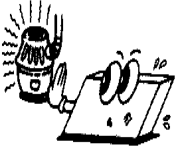
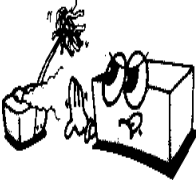
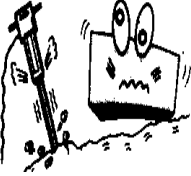
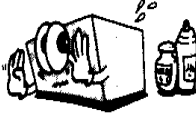
Environment Instructions

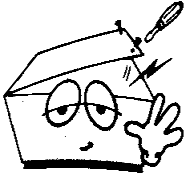
- Please do NOT use or place the product in such an environment explained below.

	<p>Avoid placing in an area exposed to moisture. Do not touch the equipment with wet hands.</p>		<p>Avoid exposure to direct sunlight.</p>
	<p>Avoid placing in an area where there is a high variation of temperature. Operating temperature ranges from 10 to 40°C (50 to 104°F) and humidity ranges from 30 to 85%.</p>		<p>Avoid placing in the vicinity of electric heaters.</p>
	<p>Avoid placing in an area where there is an excessive rise in humidity or a ventilation problem.</p>		<p>Avoid placing where there is an excessive shock or vibration may occur.</p>
	<p>Avoid placing in an area where chemicals are stored or where there is danger of gas leakage.</p>		<p>Avoid inserting dust, and especially metal material into the equipment.</p>
	<p>Do not disjoint or disassemble the equipment. Medical Econet GmbH America, Inc takes no responsibility for it.</p>		<p>Power off when the equipment is not fully installed. Otherwise, equipment could be damaged.</p>

Safety Instructions for Electricity

Please note the following precautions before using the product.

- Is the power supply cord proper? (100 - 240V AC)
- Is every cord connected properly to the product?
- Is the grounding connected correctly? (Otherwise, noise can occur.)

NOTE

In order to avoid signal noise, do not place the product near power generators, X-ray equipment, broadcasting equipment or mobile electric cords. These may cause the product to report inaccurately. It is important to use an independent electrical circuit and stable grounding. When sharing an electrical outlet with other appliances, the result may also be inaccurate.

NOTE

The classification of Cardio M Plus is as below:

- Its classification against electric shocks is Class I, Type-BF.
- It is not proper to use this product near a flammable anesthetic or solvent.
- IEC/EN 60601-1 (Safety of Electric Medical Equipment) standard, noise events: A class & IEC/EN60601-1-2 (Electromagnetic Compatibility Requirements) standard, noise level: B

NOTE

Diagnosis of Cardio M Plus needs to be confirmed by a medical specialist.

NOTE

The accessories connected to analog or digital connectors should be authorized in accordance with IEC standards (e.g. IEC 950 for data processing equipment and IEC 601-1 for medical equipment). Moreover, every composition should correspond with EN 60601-1:1993.







WARNING

This equipment must only be connected to a grounded electrical connection.

WARNING

Do not touch accessible connector pins and the patient simultaneously.

Safety Symbols

Symbols	Contents
	Isolated patient connection. (IEC 601-1-Type BF)
	Power on.
	Power off.
	ATTENTION: Refer to the user's manual.
	Ground connection.
	External Signal IN/OUT Port
	ECG

Contents

Chapter 1. General Information	12
1) Product Overview	13
2) Product Features	13
3) Product Configuration	14
Basic Components And Accessories	14
Optional Components	15
Body Configuration	16
Front Panel	19
Control Panel	21
Power	22
4) System Installation	24
Precautions For Installation	24
Power Connection	24
Patient Cable Connection	24
Paper Installation	24
System Start	25
5) System Setup	26
Reset	26
Chapter 2. Preparation For Electrocardiography	27
1) Location Of Electrode	28
2) Electrode Connection	29
Patient Cable Connection	29
How To Attach Electrodes.....	29
Countermeasures For Bad Lead Connection.....	30

Chapter 3. Electrocardiography	31
1) To Start	33
2) Basic Setup	34
General	34
Sensitivity Setup	35
Printing Speed Setup	35
Channel Form Setup	36
Rhythm Printing Setup	37
Grid On/Off	37
Beat Report Setup	38
Diagnosis Printing Setup	39
Rhythm Lead	39
Patient Information Input	40
Pediatrics Diagnosis	42
3) LCD Monitor Display	43
4) Rhythm Mode Printing	45
Printing Speed	45
How To Print	45
5) Record Mode Printing	46
10 Second ECG Recording	46
60 Second ECG Recording	47
5 Minute ECG Recording	48
6) Printing Form	49
7) Copy Mode Printing	55
8) Device Setup	57
Basic Setup	57
Network Setup	69
Hospital Setup	70
9) Network Functions	71
10) Data Management	72

Chapter 4. System Management..... 75

- 1) Maintenance And Cleaning..... 76
- 2) Regular Check-Up 76
- 3) Trouble Shooting..... 76

Chapter 5. Specification 78

Chapter 1. General Information

1) Product Overview

2) Product Features

3) Product Configuration

Basic Components And Accessories

Optional Components

Body Configuration

Front Panel

Control Panel

Power

4) System Installation

Precautions For Installation

Power Connection

Patient Cable Connection

Paper Installation

System Start

5) System Setup

Reset

1) Product Overview



Cardio M Plus is an electrocardiogram (EKG) device capable of measuring and recording 12 channels of cardiac signals of patients. The device enables operators to record cardiac signals, review them using various viewing modes, and perform automatic detection of cardiac conditions.

In addition, the device allows operators to enter patient information for it to be printed alongside cardiac signals, so that operators can sort and manage charts conveniently. Furthermore, user convenience has been further enhanced by addition of a functionality that can initiate EKG recording & saving, filter enhancing, parameter sorting and automatically detecting cardiac signal all at once by pressing one key.

A battery (optional) can be added to the device so that the device can be operated conveniently during bedside visits or emergency conditions.

2) Product Features

- Print 12-channel (ch) cardiac signals with reports in: 3ch+1 rhythm, 3ch+3 rhythms, 6ch+1 rhythm, and 12ch rhythm patterns on A4 size printing paper.
- Record a rhythm from 1 channel for 60 seconds or 5 minutes then print it on A4 size printing paper.
- Record and print 12 channel rhythms continuously and simultaneously.
- Calculate heart rate, P-R-T axis and PR, QRS, QT and QTc widths from recorded signals automatically and print them on a report for use in rhythm analysis.
- Get diagnostic reports using automatic detection functionality.
- Able to modify filter setting, signal sensitivity, printing speed, channel view settings and rhythm settings, and print on previously recorded EKG signals to aid data analysis.
- Able to attach a battery so that the device can become portable.
- Manage chart effectively by addition of patient and operator data on EKG printout.
- Up to 120 EKG recordings can be saved in device memory.

3) Product Configuration

The Cardio M Plus system consists of the items below. Unpack the package and check the items below are included. Also, be sure to check for any damage to the body and accessories.

Basic Components And Accessories



- ① Cardio M Plus Body (1 ea.)
- ② Patient Cable (1 ea.)
- ③ Disposable Electrodes (1 set)
- ④ ECG Clips (1 set)
- ⑤ ECG Paper (1 ea.)
- ⑥ Rechargeable Battery
- ⑦ User Manual (1 ea.)
- ⑧ Power Cord

Body Configuration

▣ Top View

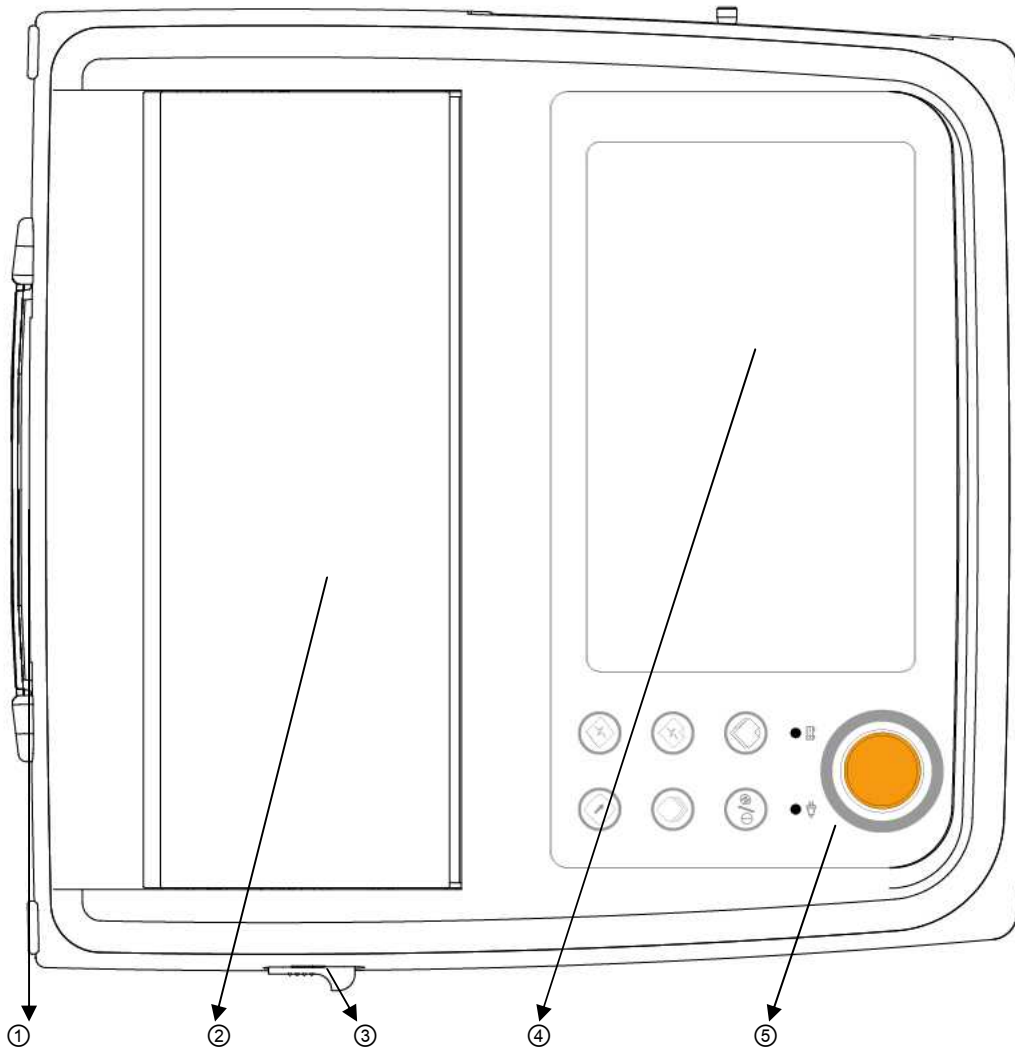

- ① Handle
- ② Printer Cover
- ③ Printer Cover Opening Button
- ④ LCD
- ⑤ Control Panel

Cardio-M Plus Operation Manual

▣ Front View

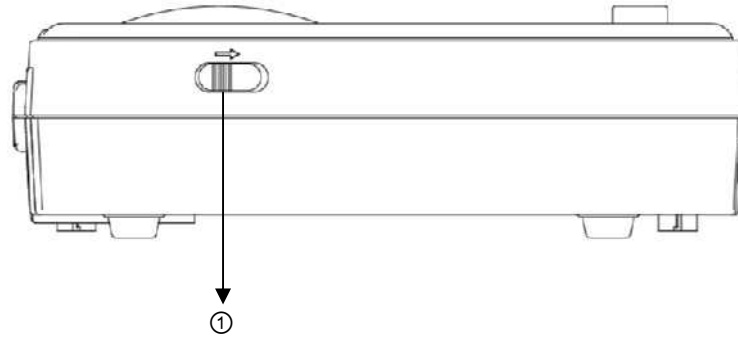

① Printer Cover Opening Button

▣ Rear View

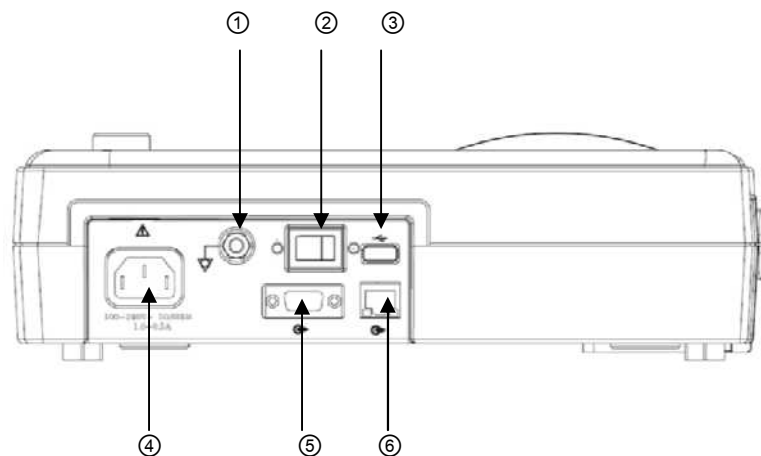

① Protective Ground Terminal

② Power Switch

③ USB Port

④ AC Power Connection Port

⑤ RS-232C Serial Port

⑥ RJ45 LAN Port

Cardio-M Plus Operation Manual

▣ Left Side View

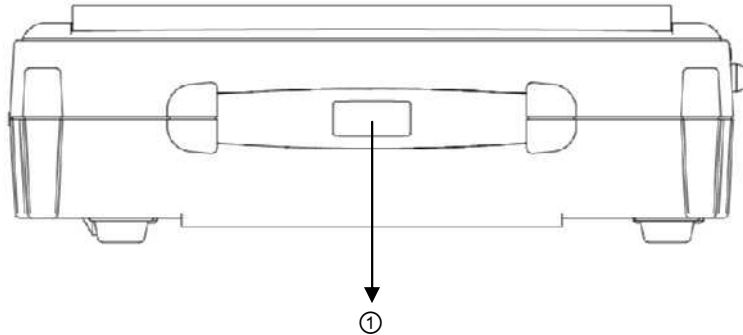

① Handle

▣ Right Side View

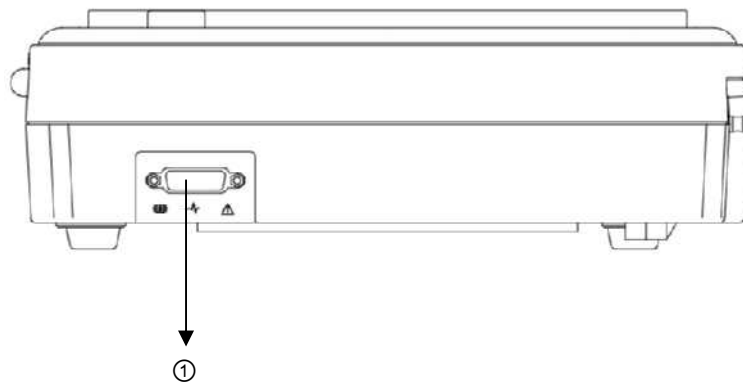

① Patient Cable Connection Port

NOTE

To avoid an expected electric shock, do not open the equipment cover or disassemble the equipment. Refer servicing to Medical Econet GmbH America, Inc.

Front Panel

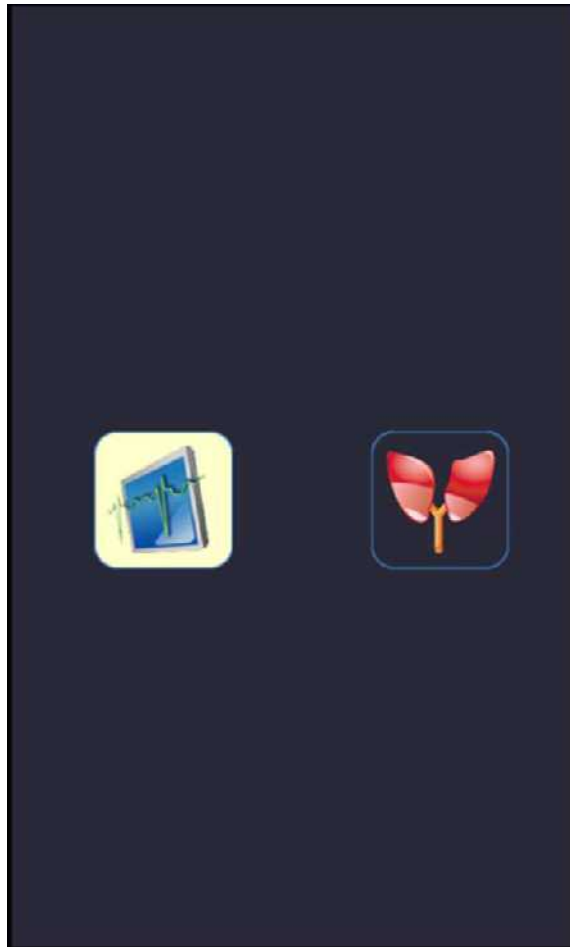

Graphic display window

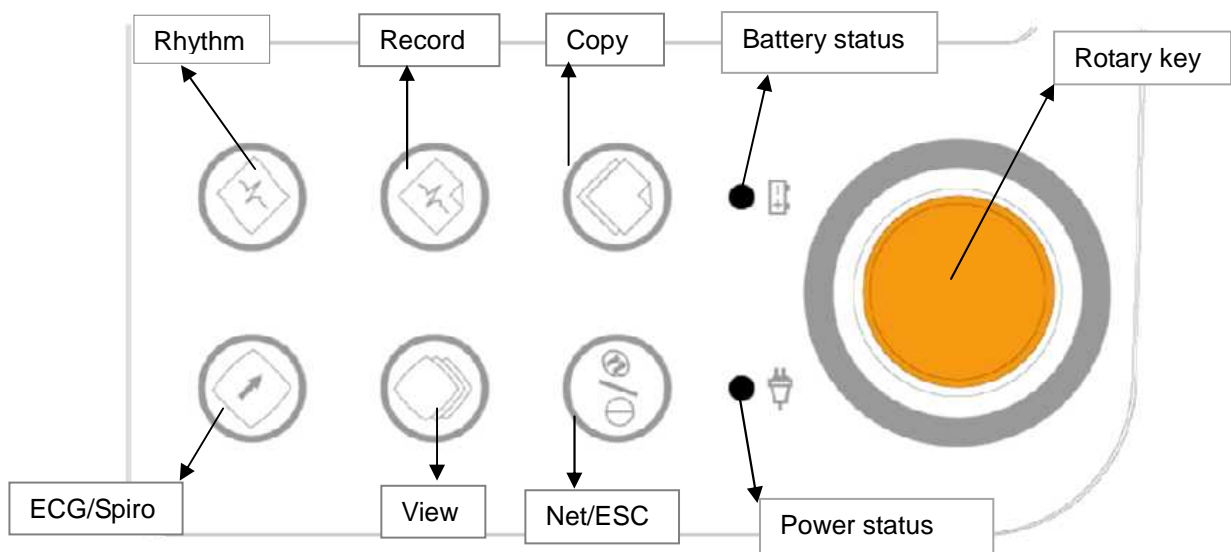

Cardio-M Plus Operation Manual

During device boot up, you can see the system version and the Medical Econet GmbH name.

Cardio-M Plus Operation Manual

The following descriptions explain data on the graphic LCD.

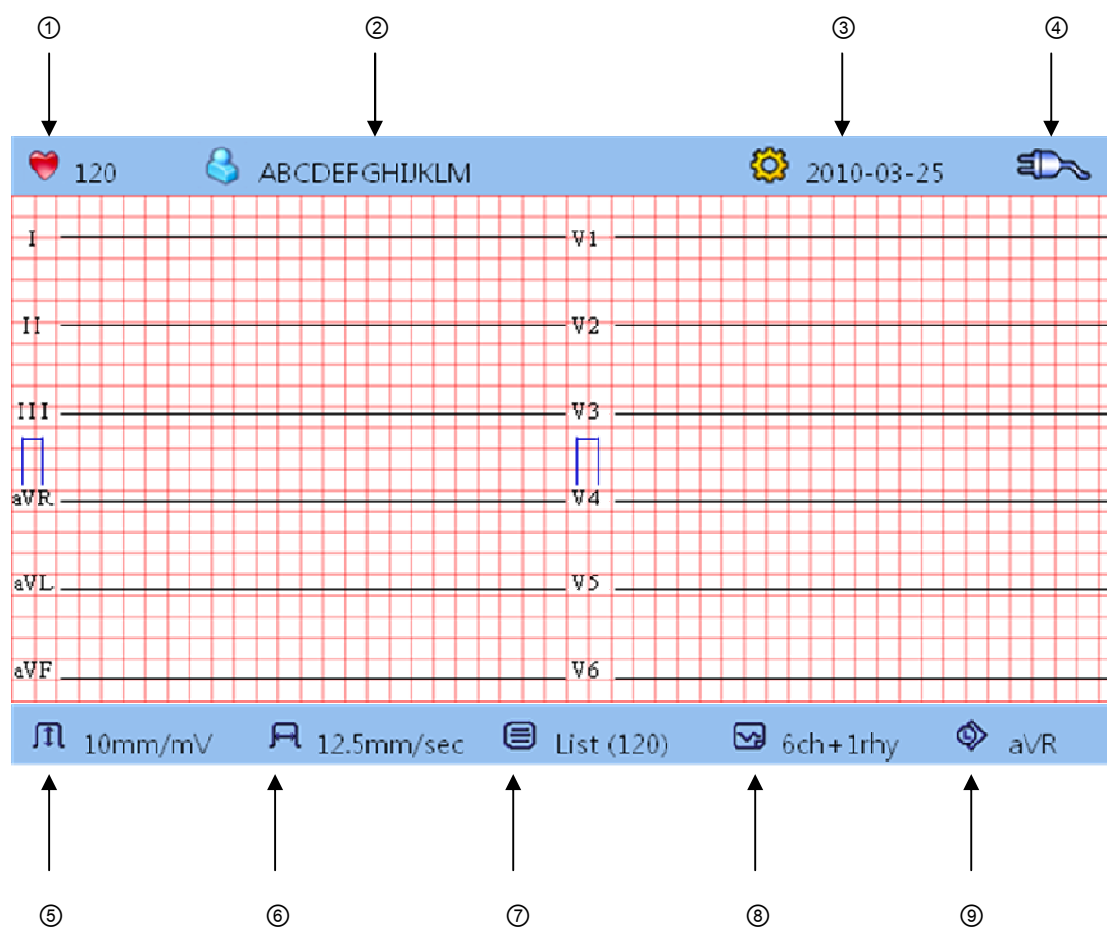

- ① Displays The Heart Rate.
- ② Displays Patient ID.
- ③ Displays The Date.
- ④ Displays Battery Status or AC Power Connection Status.
- ⑤ Displays ECG Sensitivity with One of 5, 10, 20, and Auto (mm/mV).
- ⑥ Displays Printing Speed With One Of 12.5, 25, And 50 (mm/sec).
- ⑦ Displays Number Of Data In Memory.
- ⑧ Displays A Printing Report Channel Form With One Of 3ch+1rhy, 3ch+3rhy, 6ch+1rhy, 12ch rhy, 60s 1rhy and 5m 1rhy.
- ⑨ Displays a Rhythm Channel Setup with One Of I, II, III, aVR, aVL, aVF, V1, V2, V3, V4, V5 And V6.

Control Panel

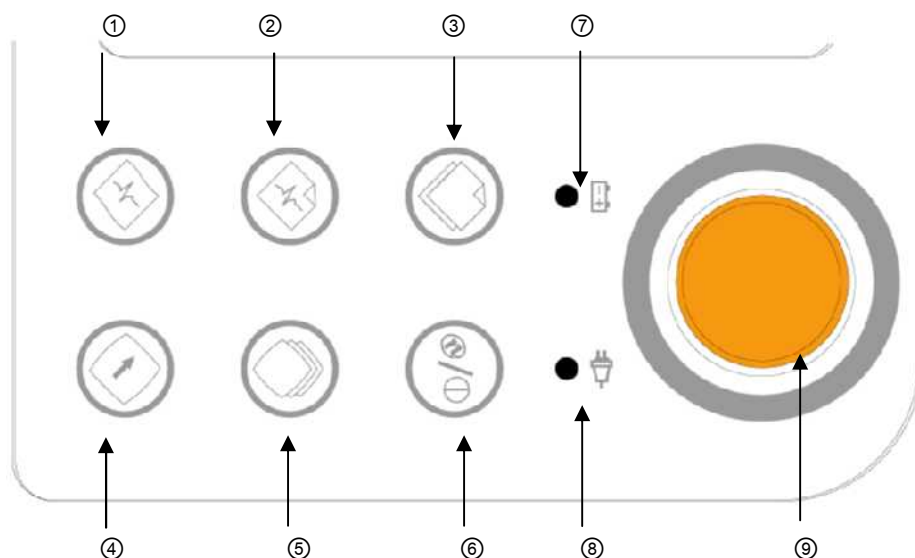



▣ Button

①		Print out the rhythm data on A4 size or continuous paper.
②		Print out the data in a selected form after recording 10 sec data or 60 sec data.
③		Process the recorded data with or without revision and print them out.
④		Change a view of the graphic display window to initial main window.
⑤		Change the view of the graphic display window.
⑥		NET: Execute communication using networking. ESC: Cancel commands or change into the former mode for main menu printing. (This key is context sensitive.)

Cardio-M Plus Operation Manual

▣ LED

⑦		A light indicator lets you know that the battery is on and shows your current battery charging status. A red light indicator lets you know that the battery is charging and a green light indicator lets you know the batter is fully charged.
⑧		Green light indicates connection with an AC adapter.

▣ Rotary Switch

⑨		Use when navigating or selecting menu items (same functionalities can be achieved by touching menu items on the screen).
---	--	--

Power

▣ AC Power

When AC Power is connected to the device, power LED light will be green; if the battery is installed, charging will commence.

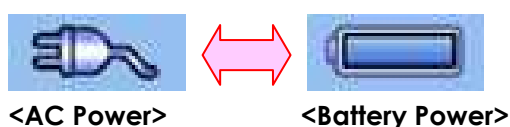





▣ Battery Power

The device will get its power from the battery and the unit will display the battery power icon (shown above), when the system is powered on, the battery is connected to the device and the AC power is disconnected. When the battery power is low, an alarm sound will ring from the device speaker and LCD display will show a "Battery Low" message. Connect the AC power immediately or the device will automatically shut down in a few minutes.

- Charging time: Maximum 4 hours
- Time to use continuously: Over 1 hour(100 ECG printouts)

▣ Display Battery Power Status

-  : Battery Fully Charged
-  : Battery Charge Half-Full
-  : Battery Charge Low
-  : Battery Almost Fully Drained

▣ Replacing Battery

When replacing battery for this device, the same type of battery should be used.

- Type: GP1300AAM-PACK Ni-MH battery (12V/2600mAh)
- When to replace: Battery will automatically be charged when the device is connected to AC power, and cannot be charged when separated from the device. Battery is designed to have a charging cycle of 500 times or more. If the device could only last 20 minutes or less on a battery power, the battery needs to be replaced. Additionally, when a battery pack is damaged or leaking chemicals, replace it immediately. Do not use damaged battery packs with the device.

NOTE

When replacing the fuse, use the same type (T3A250V) to protect the device from risk of fire.

4) System Installation

Precautions For Installation

While installing Cardio M Plus, please pay attention to the following items:

- Use the equipment between the ambient temperature 10 to 40°C (50 to 104°F) and humidity 30 - 85%.
- Check the power cord is properly connected, and the probe carefully handled.
- Do not plug multiple cords in a power outlet.
- Install and operate Cardio M Plus unit on a flat surface.
- If you experience noise, ground the device.
- Do not use a power cord that may make a connection noise.
- Device preference will be recorded in the internal memory even when it is off.
- Prevent any shock or excessive force that may cause damage to the device.
- Place the device away from any dust or flammable materials.

Power Connection

The equipment needs electrical power to operate. Plug in one end of the power cable to wall socket and the other to Cardio M Plus.

Patient Cable Connection

- Connect the patient cable to the patient cable connection port on the right side of the body.
- Connect limb electrodes to RL (N), LL (F), RA(R), and LA (L) leads of the patient cable and chest electrodes to V1 (C1), V2 (C2), V3 (C3), V4 (C4), V5 (C5), and V6 (C6), respectively.

Paper Installation

- Push the printer cover release button to the right to open the printer door of the Cardio M Plus. Install EKG paper with the side to be recorded appearing on top. Close the cover to finish the paper installation process.

System Start

- After all installation processes are finished; turn on the power switch to see the Cardio M Plus logo, system firmware version, the company name, and icons for ECG or spirometer mode displayed on the LCD screen.

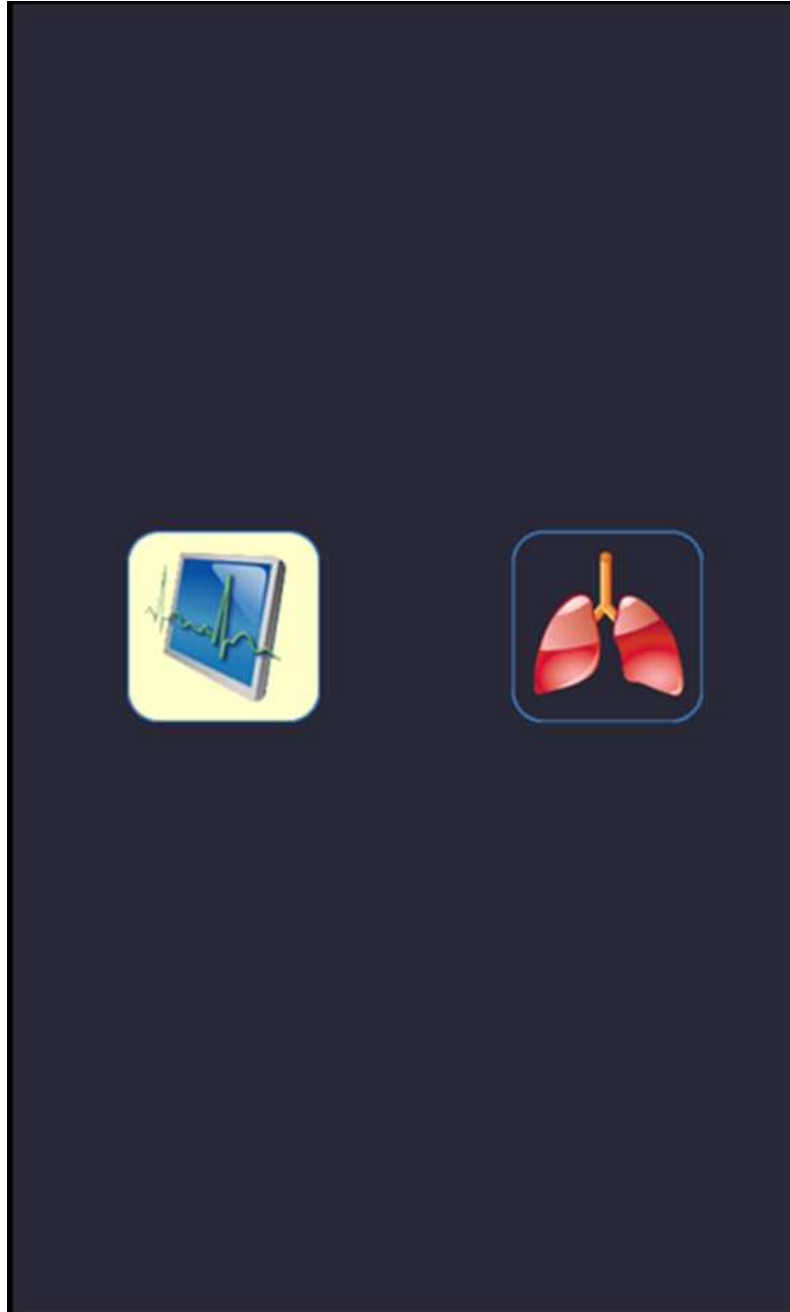

- To select ECG mode, locate the selection box on the ECG and press the rotary key or touch the selection box on the screen.

5) System Setup

Reset

Press the VIEW key on the control panel for more than three seconds to initialize the system setup to the factory mode. In three seconds, the following messages are displayed for a second and then reset starts.

SYSTEM MESSAGE
Factory Default Setting Loading...

* Defaults Are As Follows:

Sensitivity (SENS)	10mm/mV
Printing speed (SPD)	25mm/s
Grid (GRID)	Off
Channel form (FORM)	6ch+1rhy
Rhythm channel (RHY)	II
Base Line filter (BASE)	On
EMG filter (MUSC)	Off
Power noise filter (AC)	60Hz when ENG, ENG_US setting 50Hz for other languages
Low pass filter (LPF)	40hz
Diagnosis (Diagnosis)	On
Stored Data (List)	Delete
Pace Maker (P/M)	Off
Lead Fault (L/F)	On
Unit Setting(unit)	cm/kg
Beat form	On
Monitoring Form	Continue
QRS Sound	Off
File Save	Off
Printer Line	Normal

Chapter 2. Preparation For Electrocardiography

1) Location Of Electrode

2) Electrode Connection

Patient Cable Connection

How To Attach Electrodes

Countermeasures For Bad Lead Connection

1) Location Of Electrode

Attach electrodes to the patient's body to record an electrocardiogram of twelve standard leads [I, II, III, aVR, aVL, aVF, V1, V2, V3, V4, V5, V6], as shown below.

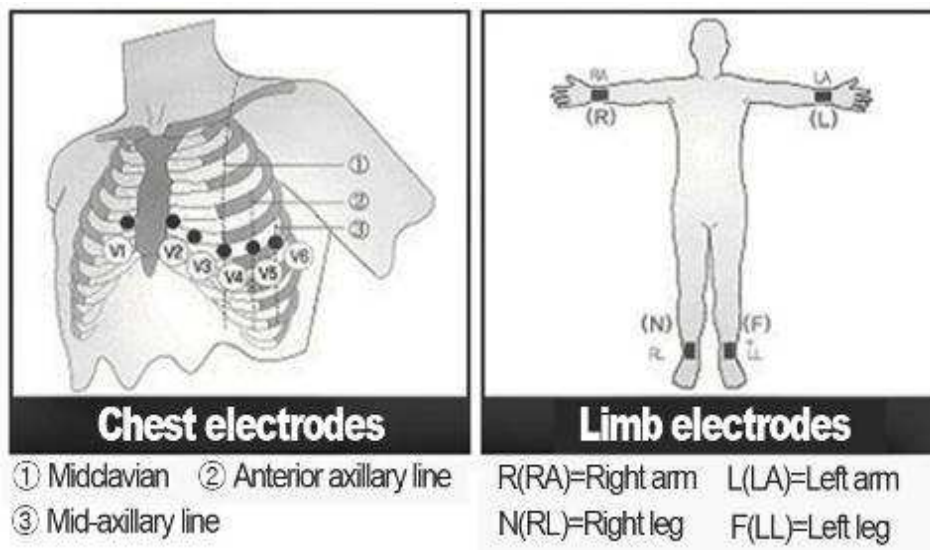

Limb electrodes are located as follows.

- RL (N): Right Leg
- LL (F): Left Leg
- RA (R): Right Arm
- LA (L): Left Arm
- V1 (C1): Fourth Intercostal Space At The Right Border Of The Sternum
- V2 (C2): Fourth Intercostal Space At The Left Border Of Sternum
- V3 (C3): Midway Between Location V2 and V4
- V4 (C4): At The Mid-Clavicular Line In The Fifth Intercostals Space
- V5 (C5): At The Another Axillary Line On The Same Horizontal Level As V4
- V6 (C6): At The Anterior Axillary Line On The Same Horizontal Level As V4 and V5

2) Electrode Connection

* Check Points

Check the status of equipment and attachment to patient's body before measuring.
Check for any mechanical danger.
Check cables and accessories connected to the outside.
Check all the devices to measure the patient.

Patient Cable Connection

Connect the patient cable to the patient cable port of the Cardio M Plus.

How To Attach Electrodes

Attach electrodes after placing the patient on the bed, helping him/her to be relaxed, and cleaning electrode contact points on the patient's skin by using a disinfective alcohol or water. Finally, attach leads to the parts as explained in aforementioned "location of electrode" part.

Caution

Use only electrodes and patient cables provided from Medical Econet GmbH America, Inc. Medical Econet GmbH America, Inc. will take no responsibility for any accidents involving 3rd party accessories.

Countermeasures For Bad Lead Connection

After turning on the power switch, enter the ECG test to check waveforms of all leads. On this menu, operators can check waveforms of all leads and their noise, and may see "Lead Fault" message displayed on the LCD screen.

NOTE

- Message will be displayed when L/F is set to ON in System Setup, and will NOT be displayed when set to OFF.
- "Lead Fault" message will appear, and a buzzer alarm will go off when lead fault occurs during printing.

Lead Fault! All Leads.

The following two cases could cause a lead fault error.

- First case, leads are detached from the patient's body. In this case, re-attach leads normally.
- Second case, signal conductivity between leads and the patient's body is low. In this case, replace the electrodes.

If the two above cases have been performed and the operator is still experiencing noise or lead fault conditions, the patient cable may be faulty. Please contact the Medical Econet GmbH service center.

Chapter 3. Electrocardiography

1) To Start

2) Basic Setup

- General
- Sensitivity Setup
- Printing Speed Setup
- Channel Form Setup
- Grid On/Off
- Rhythm Printing Setup
- Beat Report Setup
- Diagnosis Printing Setup
- Rhythm Lead
- Patient Information Input
- Pediatrics Diagnosis

3) LCD Monitor Display

4) Rhythm Mode Printing

- Printing Speed
- How To Print

5) Record Mode Printing

- 10 Second ECG Recording
- 60 Second ECG Recording
- 5 Minute ECG Recording

6) Printing Form

7) Copy Mode Printing

8) Device Setup

Basic Setup



Network Setup

Hospital Setup





9) Network Functions

10) Data Management

1) To Start

- . Connect leads to the patient, and then turn on the device in accordance with the preparation steps for measuring electrocardiogram in Chapter 2.
- . Set up filter, sensitivity, printing speed, channel form, and rhythm settings in accordance with the steps shown in "Basic Set-Up" in Chapter 3.
- . Enter the patient information in accordance with the steps of "Basic Setup" in Chapter 3.
- . If the waveform displayed on the LCD is abnormal or has excess noise, follow the instruction of "Countermeasures by Bad Lead Connection" in Chapter 2.
- . If the waveform displayed on the LCD is normal, press the REC key to record the electrocardiogram of the patient.
- . To copy the same report as the previously printed report, press the COPY  key
- . To do monitoring signal by printer, press the RHYTHM  key
- . To stop the machine during the printing or saving processes, press the STOP  key

The following buttons will be most commonly used when operating Cardio M Plus.

	Rhythm Printing: Pause monitoring on the LCD display, and print real-time waveform using the printer. Can get either continuous or A4 sized EKG rhythm printouts.
	Diagnostic Printing: Record 10 seconds of data starting after button is pressed. Then, the device will extract important parameters for diagnosis and print the summary on an A4 sized printout.
	Copy Printing: Reprint the report with the same settings or adjusted settings. The following settings can be adjusted between printouts; such as, filter, wave sensitivity, printing speed, channel mode, etc.
	Pause: Used when cancelling execution, returning to previous mode when entering main menu or pausing the printer during printing.

2) Basic Setup

General

When the device is on, the current configuration values of the system will be shown on the LCD in the order of the heart rate, patient information, time, battery status, sensitivity, printing speed, application of the base line filter, application of the electromyogram filter, printing channel configuration, and selection of the rhythm lead.

These configuration values can be changed using either a rotary key or touch screen. With the rotary key, the desired menu and changed configuration values can be set easily.

Same functionality can also be achieved with the touch screen by pressing and changing the desired information on the LCD.

1. Changing The Configuration Value With The Rotary Key

In this case, please follow these steps: enter Menu Mode, navigate and select Menu and then change values.

- Entering Menu Mode: Operate by rotating the rotary key clockwise or counter-clockwise.
- Menu Navigation: Operate by rotating the rotary key. Menu movement will occur in the same direction as the direction of the key's rotation.
- Menu Selection: Initiate by pressing the rotary key. Menu box for setting of the selected menu will be displayed.
- Modifying setting values: Move to desired setting, then modify & select values in the same manner as menu movement shown above. If there are any previously set values, setting the menu box with the previous value will appear. If there are no OK buttons, setting the menu will automatically close and return to setting the menu display. If there are a lot of setting values, enter them all, then click on the OK button to indicate data entry is complete to close the menu box.

2. Changing The Setup Value With The Touch Screen

You select Menu and change the setup value.

- Select Menu: You could select the menu by touching the screen. Unlike the rotary key, the setup box appears when you select Menu.
- Change the value: You need to touch the item on the screen to select.

(In the event of system configuration, you should use only the rotary key to set up a value.)

Sensitivity Setup

This is a functionality that can modify sensitivity of the output signal, when the outputting signal's amplitude is too large to cause overlap with neighboring signals, or too small so that signal diagnosis is difficult.

Users can set all 12 channels to 2.5mm/mV, 5mm/mV, 10mm/mV or 20mm/mV. Users can also set it to Auto which will automatically set the sensitivity level for each channel; for example I, II, III, aVR, aVL, aVF to 10 mm/mV and V1, V2, V3, V4, V5, V6 to 5mm/mV. Note that 10mm/mV means printing 1mV signal as 10mm in amplitude on the printing paper.

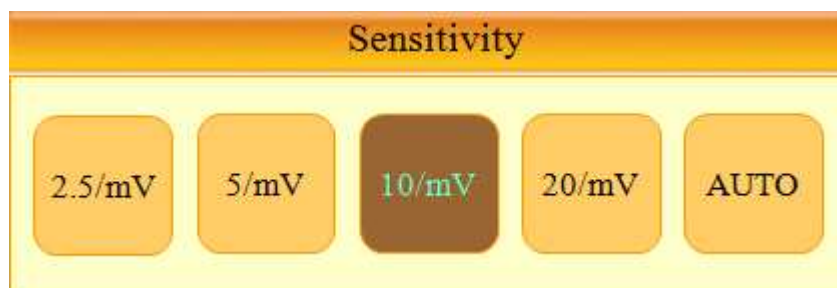

To change the sensitivity of the signal, select and enter the wave amplitude menu on the main display () using the rotary key or touch screen, and open the setting menu display shown above. After that, use the rotary key to select the desired sensitivity level and press down to enter or select it using the touch screen to set the size of waveform displayed on screen.

Selected values are shown on the bottom of EKG printouts in the following way: when 2.5, 5, 10 and 20 are selected, they will be displayed as "all channels: 2.5mm/mV," "all channels: 5mm/mV," "all channels: 10mm/mV" and "all channels: 20mm/mV" When Auto is selected, sensitivity level will be printed as "I-aVF: 10mm/mV, V1-V6: 5mm/mV."

The left side of the graph display will show the channel name and a bar graph, so users can notice recently changed values easily. (For 20mm/mV, only one bar graph will appear so that overlapping of indicators does not occur.)

Printing Speed Setup

This is the function used to adjust the width of the signal displayed. Three values, 12.5 mm/s, 25 mm/s, and 50 mm/s are available for adjustment. 25 mm/s means to record the signal of the electrocardiogram for a second on 25 mm. Therefore, the width of 12.5 mm/s is a half of the width of 25 mm/s, and the width of 50 mm/s becomes two times the width of 25 mm/s. If you want to record the broad width of the signal, set up the higher value.



To modify EKG waveform's printing speed, place the selection block to speed information menu (J1) by rotating the rotary key, then press it to select or touch the speed information menu directly. The above Printing Speed menu will be shown. Select desired speed using the rotary key or touch screen. Set value will be displayed on the bottom of the printout form as 12.5mm/s, 25mm/s or 50mm/s. Note that if the user wishes to print in A4 size, set the printing size to 25mm/s.

Channel Form Setup

Select the channel form setting of the Printing Form. Currently 6 types of channel forms (3ch+1rhy, 3ch+3rhy, 6ch+1rhy, 12ch rhy, 60s 1rhy and 5m 1rhy) are offered in Cardio M Plus.



To select the printout channel form settings, place the selection block to the print setup menu. (J2) and press down using the rotary key or touch screen input to select the desired channel forms in the printing form menu.

Set values will be printed on top of the printout form as: "3 Channels + 1 Rhythm Report," when it's 3ch+1rhy; "3 Channels + 3 Rhythm Report," when it's 3ch+3rhy; "6 Channels + 1 Rhythm Report," when it's 6ch+1rhy; it will show "12 Channels Rhythm Report," when it's 12ch rhy; it will show "1 Rhythm Report(60 sec)," when it's 60 sec 1rhy; and it will show "1 Rhythm Report(5 min)," when it's 5 min 1rhy.

Cardio-M Plus Operation Manual

- 3ch+1rhy mode will be showing a 10-second EKG recording with channels I, II, III for the first 2.5 seconds; aVR, aVL, aVF for the next 2.5 seconds; V1, V2, V3 for the following 2.5 seconds; then V4, V5, V6 for the final 2.5 seconds. Additionally, it will display the rhythm of the selected 1 lead on the bottom for 10 seconds.
- 3ch+3rhy mode will be showing a 10-second EKG recording with channels I, II, III for the first 2.5 seconds; aVR, aVL, aVF for the next 2.5 seconds; V1, V2, V3 for the following 2.5 seconds; then V4, V5, V6 for the final 2.5 seconds. Additionally, it will display rhythms of the selected 3 leads on the bottom for 10 seconds.
- 6ch+1rhy mode will be showing a 10-second EKG recording with channels I, II, III, aVR, aVL, aVF for the first 5 seconds; then V1, V2, V3, V4, V5, V6 for the last 5 seconds. Additionally, it will display the rhythm of the selected 1 lead on the bottom for 10 seconds.
- 12ch rhy mode will record 10-second EKG measurements of all 12 leads in the order of channels I, II, III, aVR, aVL, aVF, V1, V2, V3, V4, V5, V6.
- 60 sec 1rhy mode will record the EKG of the selected 1 lead for 60 seconds with 6 lines of 10-second long measurements.
- 5 min 1rhy mode will record the EKG of the selected 1 lead for 5 minutes with 15 lines of 20-second long measurements.

Rhythm Printing Setup

Under rhythm printing mode, the user can set whether a printout will be done continuously or fit in A4 size (10-second EKG recordings). The rhythm printout setting can be set using the printing form mode. Under Mon menu, use the rotary key or touch screen to select between A4 or continuous options.

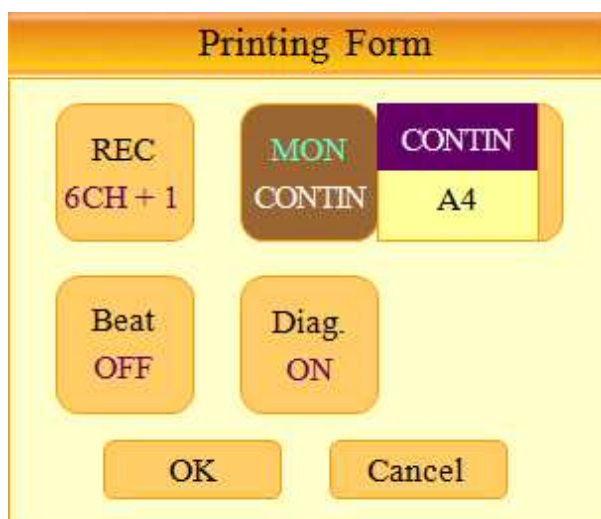

Grid On/Off

Printing grid may be needed when fax paper is used instead of EKG paper for printing. A grid line will be shown for every 5mm X 5mm space and dots for every 1mm X 1mm space. If EKG paper supplied by Medical Econet GmbH is used, the grid option should

be turned off as it already contains a grid on the paper.

The grid option could also be set on the Printing Form menu. In the Grid menu, use the rotary key or touch screen to change the grid option between ON and OFF. When the Grid option is set to ON, the grid will be printed out, and no grid will print if the unit is OFF.



Beat Report Setup

During the diagnostic print, set the output of the representative beat information. The beat report is added to regular printout (3ch+1rhy, 3ch+3rhy, 6ch+1rhy and 12ch rhy output), and has "Representative Beat Report" printed on the upper part of the printout form. This Beat report has representative waveforms of each lead and shows any important parameters calculated from recordings.

In the Beat menu under the Printing Form menu, use the rotary key or touch screen to select between ON and OFF to turn the option on or off. ON will cause the Beat report to be printed, and selecting OFF will disable the Beat report from printing.



Diagnosis Printing Setup

Under diagnosis printing mode, users can set whether diagnosis results will be printed alongside waveforms. Diagnosis printing can be turned ON or OFF in the Printing Form setting under Diag menu. ON sets diagnosis results to be printed and OFF disables diagnosis printing.

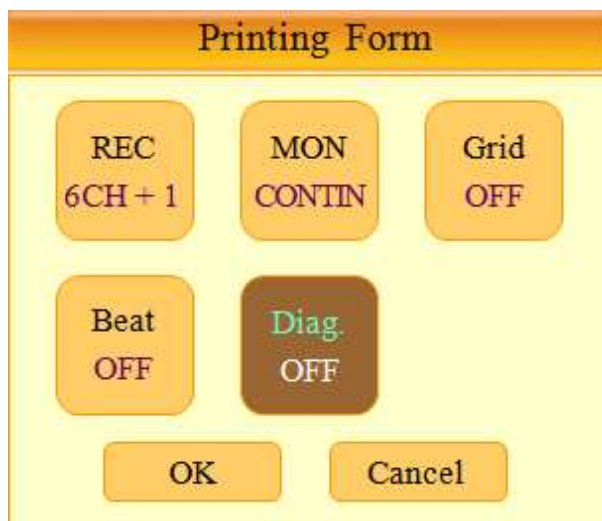

Rhythm Lead

To select Rhythm Lead, move the selection block to the Rhythm Lead setting (📏) located at the bottom of the screen and select, using either the rotary key or touch screen, to enter the Rhythm Lead setting. In the Rhythm Lead setting, select the desired channel, then select the desired rhythm lead using the rotary key or touch screen.

The lead selected from channel 1 will become the base lead in 3ch+1rhy and 6ch+1rhy modes, showing on the bottom of the printout form. It will also be used in 60 sec 1rhy and 5 min 1rhy modes as the only lead being recorded and printed. For 3ch+3rhy mode, lead selected under channels 1, 2 and 3 will be printed on the bottom of the printout and become the base rhythm for other channels.

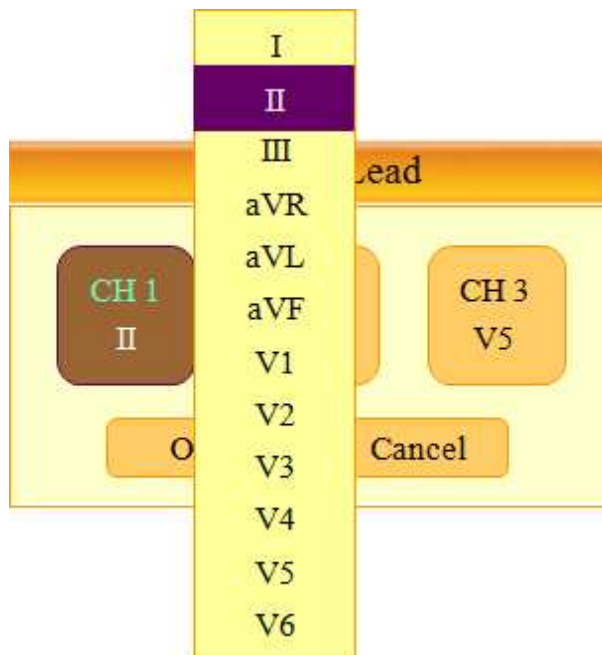

Patient Information Input

In this menu, operators can input the patient's ID, name age, sex, height, weight, race and smoking habit. In order to enter the patient's information, move the selection block to the Patient Information input setting (👤) and select input fields using either the rotary key or touch screen.

Patient Information

ID _____

Name _____

Age _____

Gender Male _____

Height _____ cm

Weight _____ kg

Race Oriental _____

Smoke No _____

<Patient Information Selection Mode>

Cardio-M Plus Operation Manual

The Information input mode will be displayed after selecting the value to enter using either the rotary key or touch screen. Use the rotary key or touch desired values on the screen to enter information. Input mode includes Keyboard for both characters and numbers and Keypad mode for numbers only. On values where only the number should be entered, users will see the keypad appear instead of the regular keyboard input.

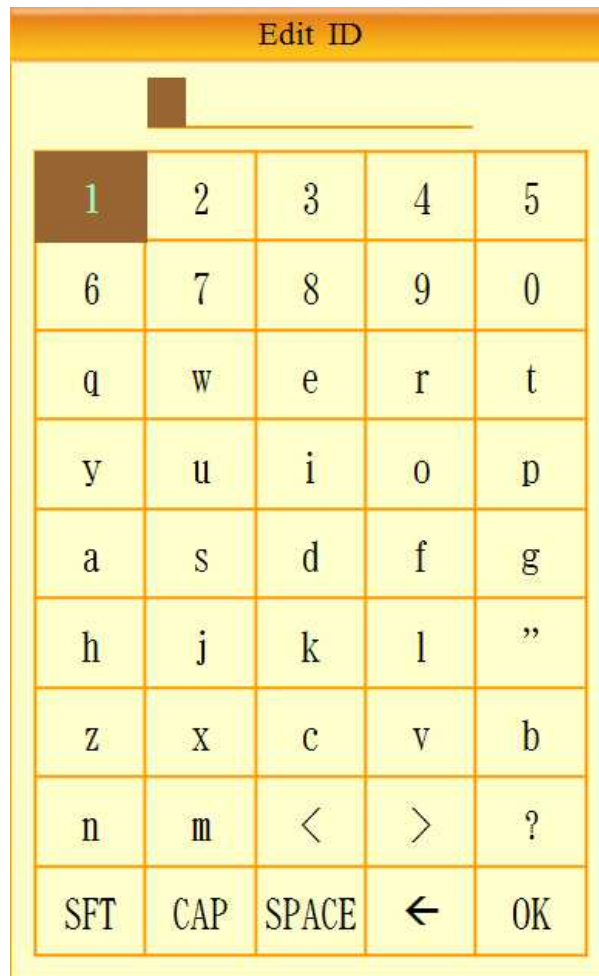

⟨Information Input Mode⟩



〈Information Input Mode〉

Pediatric Diagnosis

Pediatric diagnosis is supported for patients ages 3 to 15 years old. When entering patient information, if the input age entered by the operator in the Age section falls between 3 to 15 years old, the device will automatically apply a pediatric diagnosis. If the patient is 16 years old or older, the device will perform a regular (adult) diagnosis instead.

3) LCD Monitor Display

Monitor mode display shows the currently measured electrocardiogram signal in real time. The monitor mode display function is used for the following two purposes: One is to check whether the signals from the all channels are coming out properly; the other one is to see the status of the electrocardiogram of the patient for a long time.

Filters for the monitor mode display are below. (Setup in system setup)

BASE LINE	On (fixed)
Electromyogram Filter (EMG)	Off (fixed)
Power Supply Filter (AC)	Option
Low Pass Filter (LPF)	40hz (fixed)

The printing speed can be selected to 12.5 mm/s, 25 mm/s, and 50 mm/s, and the sensitivity can be selected to 2.5 mm/mV, 5 mm/mV, 10 mm/mV, 20 mm/mV, and Auto.

Display output can either be done in portrait or landscape views. If it's in portrait mode, press the VIEW (⊙) key to switch viewing mode. There are a total of 3 different viewing modes: one displaying all 12 leads and two displays, each showing 6 leads. The following diagram shows the display switch order with arrows indicating each press of the VIEW key.

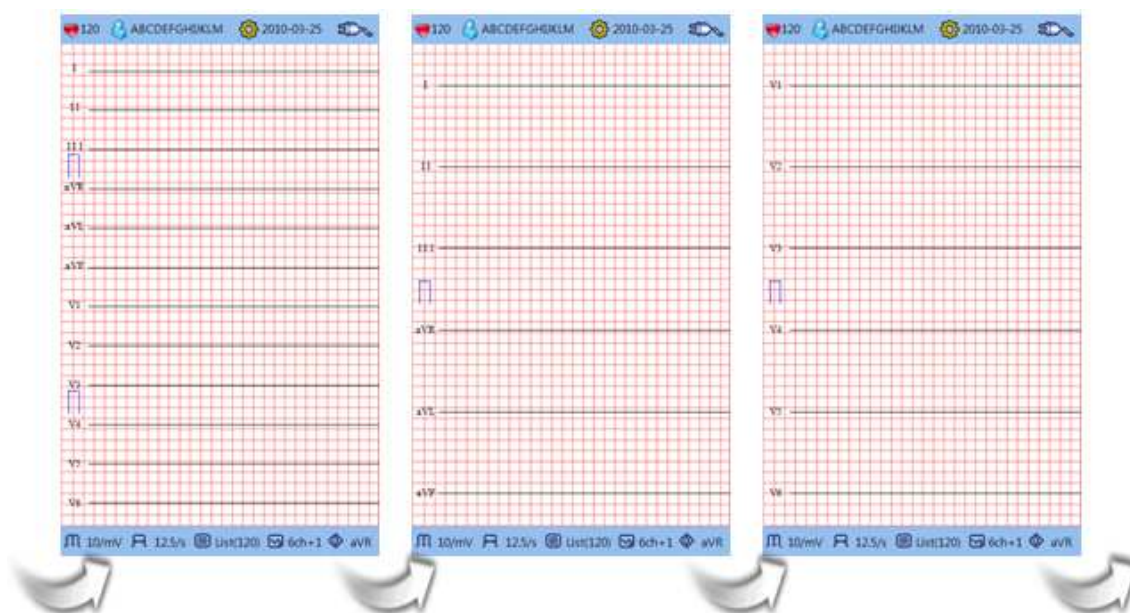

In the landscape mode, there are a total of two display options with either 2 6-lead columns or 4 3-lead columns. The following diagram shows a display switch order with arrows indicating each press of the VIEW key.

Cardio-M Plus Operation Manual

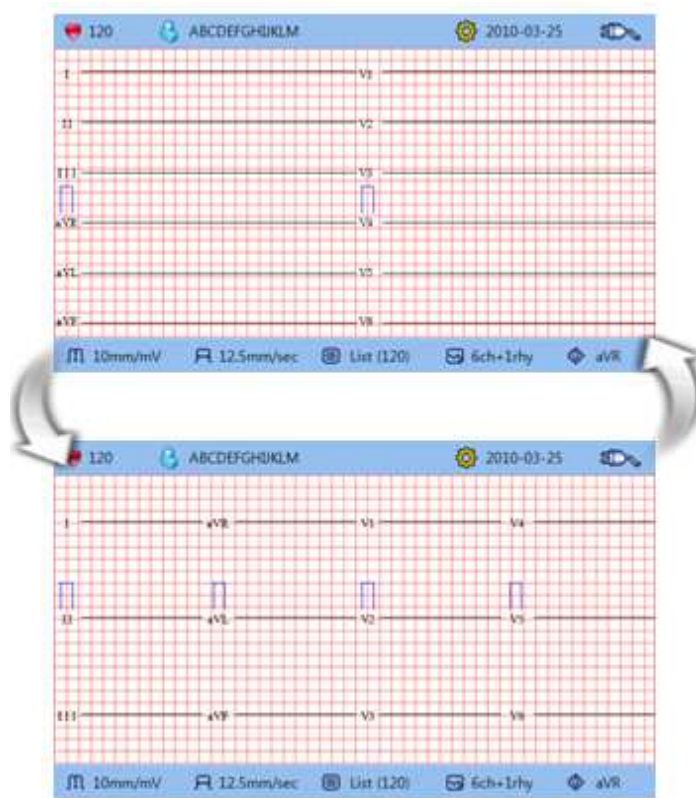

Note

Display output mode can be set in Basic Setup under the Device Setup menu.
(Please refer to the Device Setup)

* Displayed heart rate is the average of 4 heartbeats.

4) Rhythm Mode Printing

In rhythm mode printing, the measured ECG signals would be printed in real-time. Rhythm mode printing allows operators to perform the following two functions: one is to verify that signals in all channels are active before recording ECGs, and the other is to print the ECGs rhythm status of the patient for a longer duration.

In this rhythm mode, filter setting is fixed as follows:

BASE LINE	On (fixed)
Electromyogram Filter (EMG)	Off
Power Supply Filter (AC)	Option
Low Pass Filter (LPF)	40hz

Printing Speed

Printing speed can be set to 12.5 mm/s, 25mm/s, 50mm/s and signal level can be set to 2.5mm/mV, 5mm/mV, 10mm/mV, 20mm/mV, and Auto.

(In rhythm mode printing, it prints only to 25mm/s if you select the A4 printing.)

How To Print

The Filter setting value is fixed. Set the required printing speed and sensitivity and press the RHYTHM (ⓧ) key. Then, the system starts printing according to the selected speed with the following message on the LCD:



Press NET/ESC (Ⓢ) key to stop printing the EKG rhythm. After pressing the key, the system will stop printing and the display system setting after indicating the following message for 1 second on the LCD:



5) Record Mode Printing

For the record mode display, save the electrocardiogram in the memory first, and apply the filter which is set up by the user to the saved electrocardiogram, and then extract the parameters for the heart rate, PR interval, QRS duration, QT/QTc, and P-R-T axes. Then, print out the heart rate according to the sensitivity, printing speed, and channel form that are set up by the user.

10 Second ECG Recording

When one of 3ch+1rhy, 6ch+1rhy, 12ch rhy, and beat is selected for the channel form, press the RECORD (Ⓜ) key to display the saving time as below and save the 10-second data to the memory.



When the 10-second data saving is completed, the following message will be displayed on the LCD screen and the setup filter will be applied to the saved data. After that, the parameters that were required for the diagnosis will be extracted from the data.



When the data processing is completed, the following message will be displayed on the LCD screen, and then the printing will start:



Press the NET/ESC (Ⓜ) key to stop and exit while saving data or printing the EKG report. Once saving or printing stops, the following message will be displayed on the LCD screen for one second, followed by the initial screen:

SYSTEM MESSAGE

Process Canceling...

60 Second ECG Recording

When the channel form is set to 60 sec 1rhy, pressing the RECORD (Ⓜ) key will make the device record EKG data, while printing record duration for 60 seconds on a predetermined rhythm channel.

SYSTEM MESSAGE

*Record 60 seconds *

35

Once the EKG recording is done, the following message will appear on the LCD display while recorded data is filtered and processed to acquire the heart rate:

SYSTEM MESSAGE

Data Processing...

After data processing is finished, the following message will appear on the LCD screen, followed by printing of the recorded signal:

SYSTEM MESSAGE

Printing...

Press the PAUSE (Ⓜ) key to pause or exit during data saving or printing. After pressing the key, the following message will be displayed on the LCD screen for 1 second, then saving or printing will stop.

SYSTEM MESSAGE

Process Canceling...

5 Minute ECG Recording

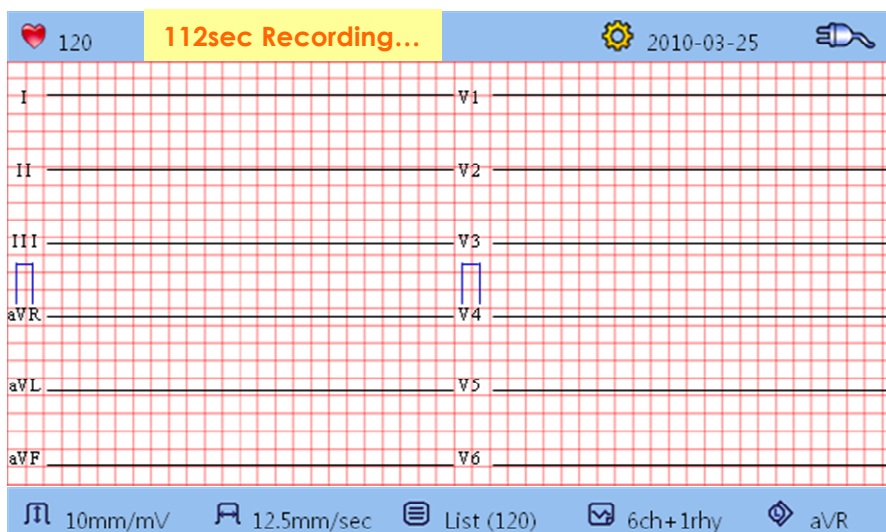

When the channel form is set to 5 min 1rhy , pressing the RECORD () key will make the device record EKG data, while printing record duration for 5 minutes on a predetermined rhythm channel.

Once the EKG recording is done, the following message will appear on the LCD screen, followed by printing of the recorded signal:



Press the PAUSE () key to pause or exit during data saving or printing. After pressing the key, the following message will be displayed on the LCD screen for 1 second, then saving or printing will stop:



6) Printing Form

In this section, descriptions and samples of various printing forms are provided.

Rhythm Report Form

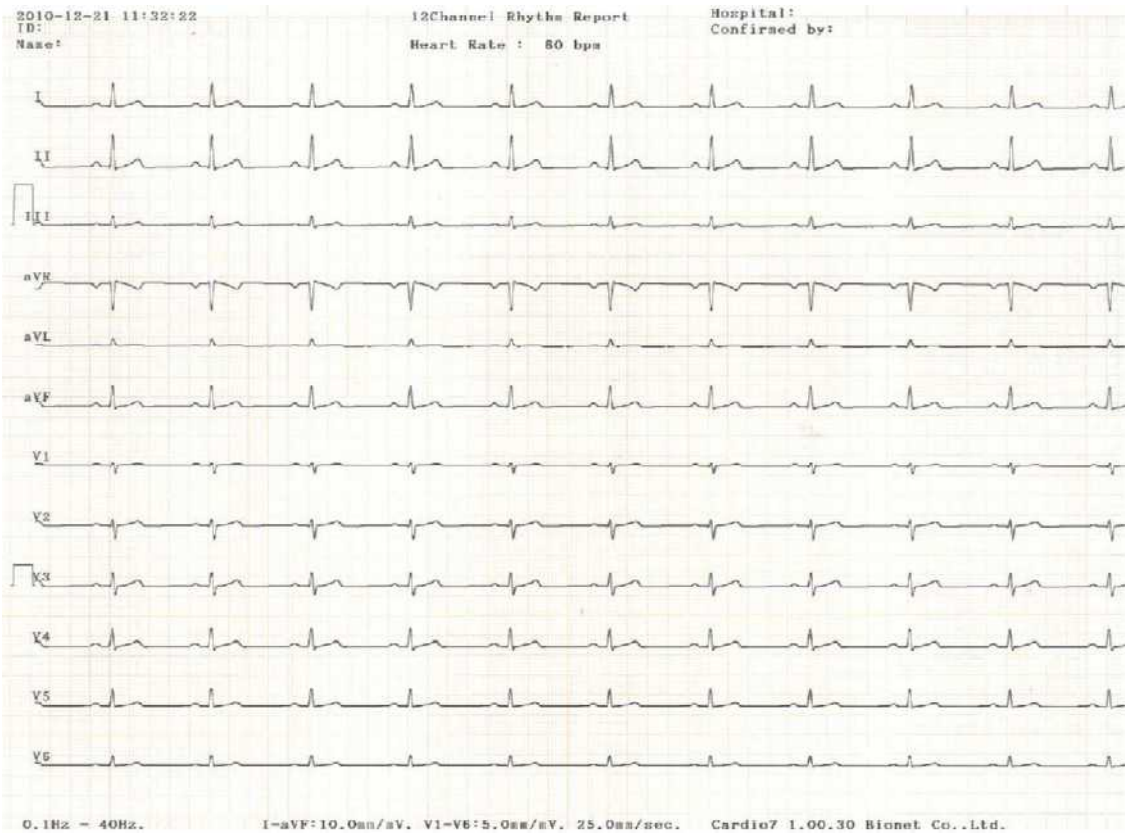

Cardio-M Plus Operation Manual

- Record Report Form (3ch+1rhy)

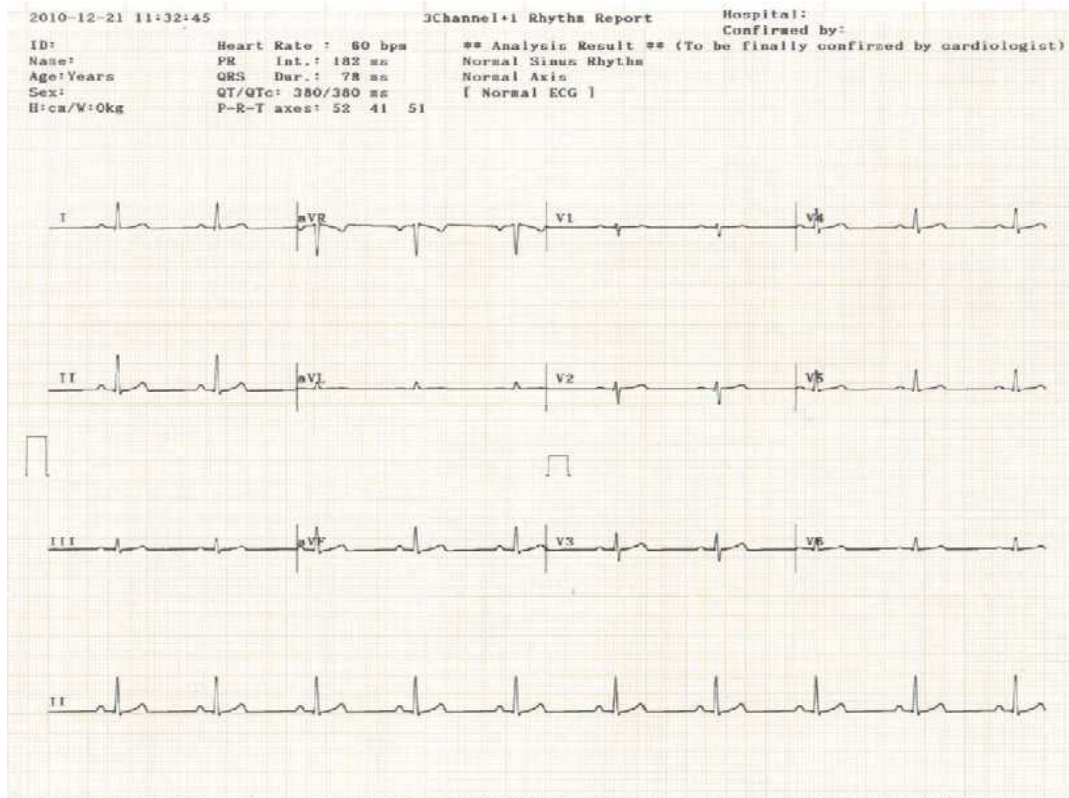

- Record Report Form (3ch+3rhy)

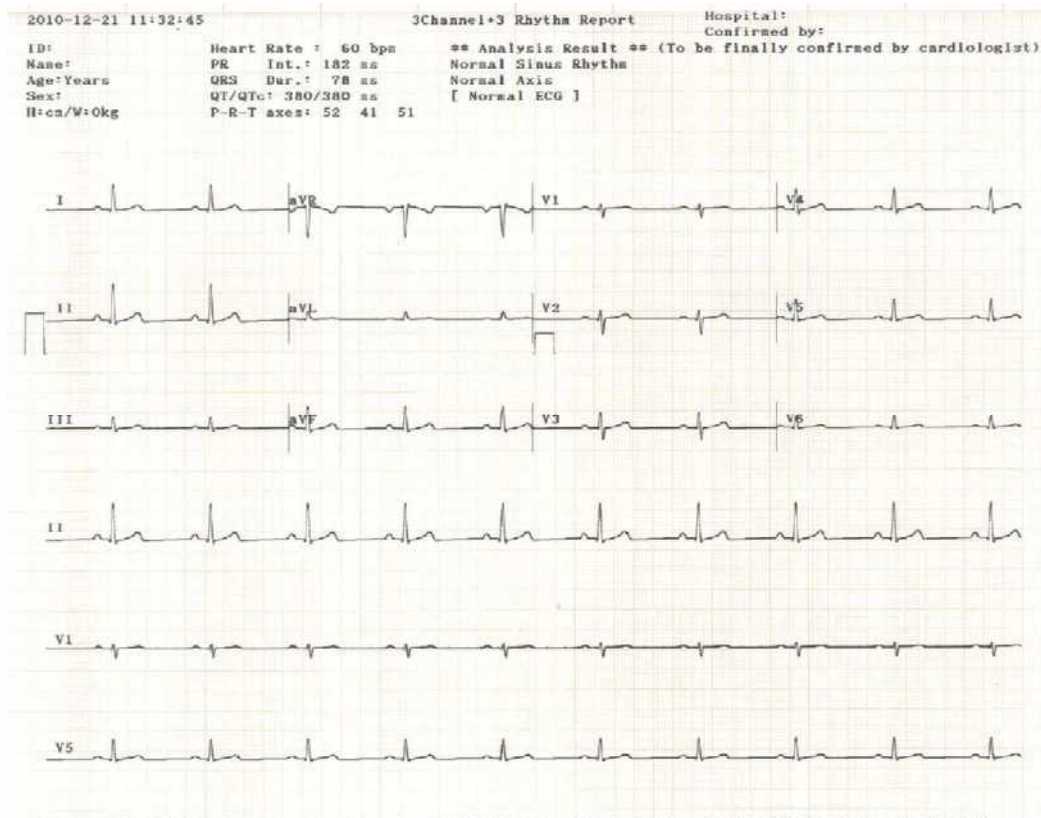

Cardio-M Plus Operation Manual

- Record Report Form (6ch+1rhy)

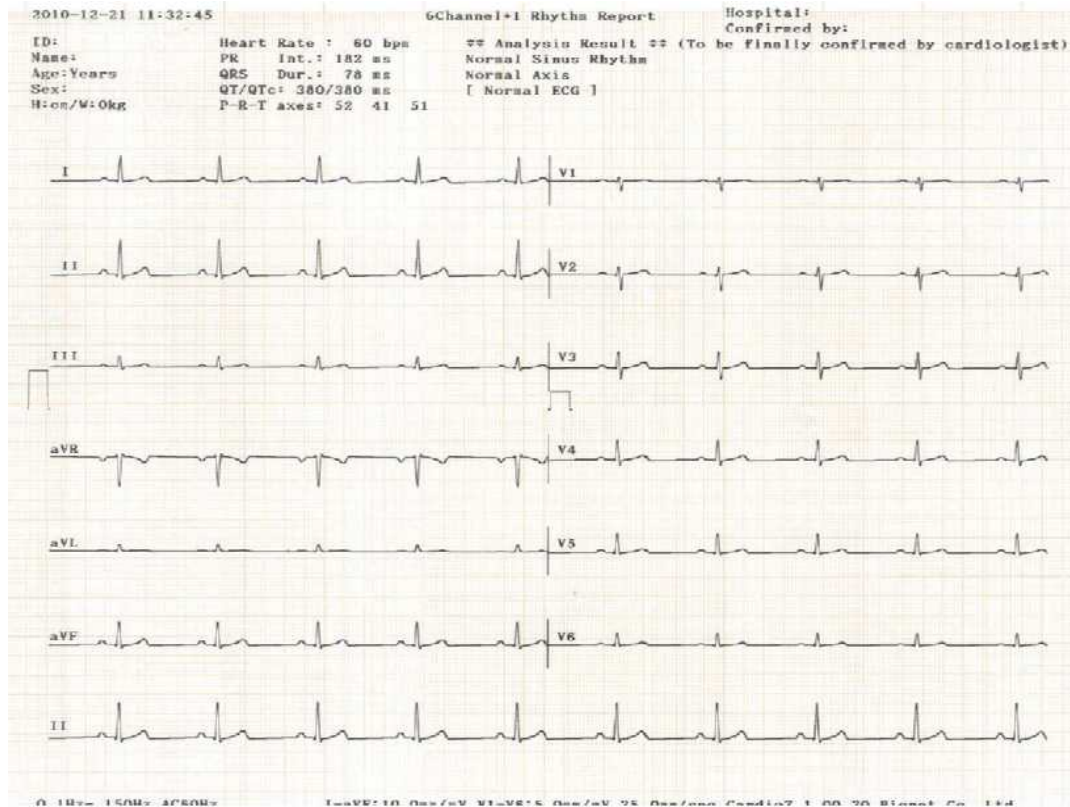

- Record Report Form (12ch rhy)

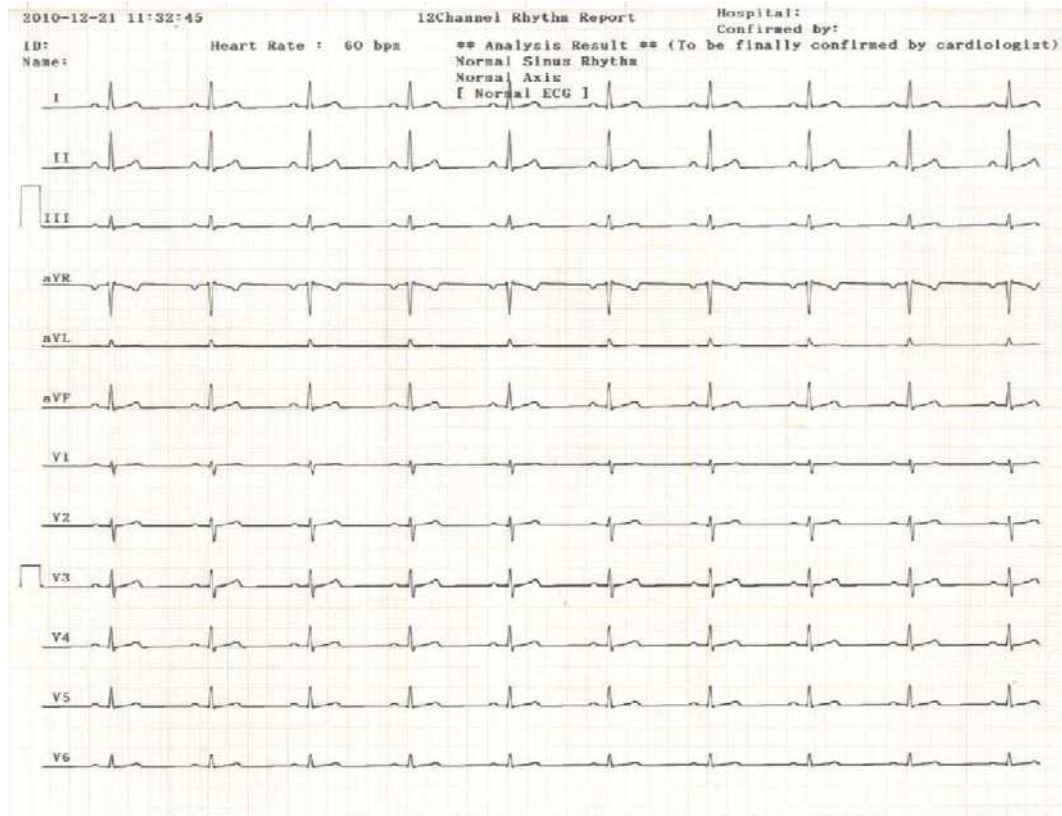

Cardio-M Plus Operation Manual

- Record Report Form (60 sec. 1rhy)

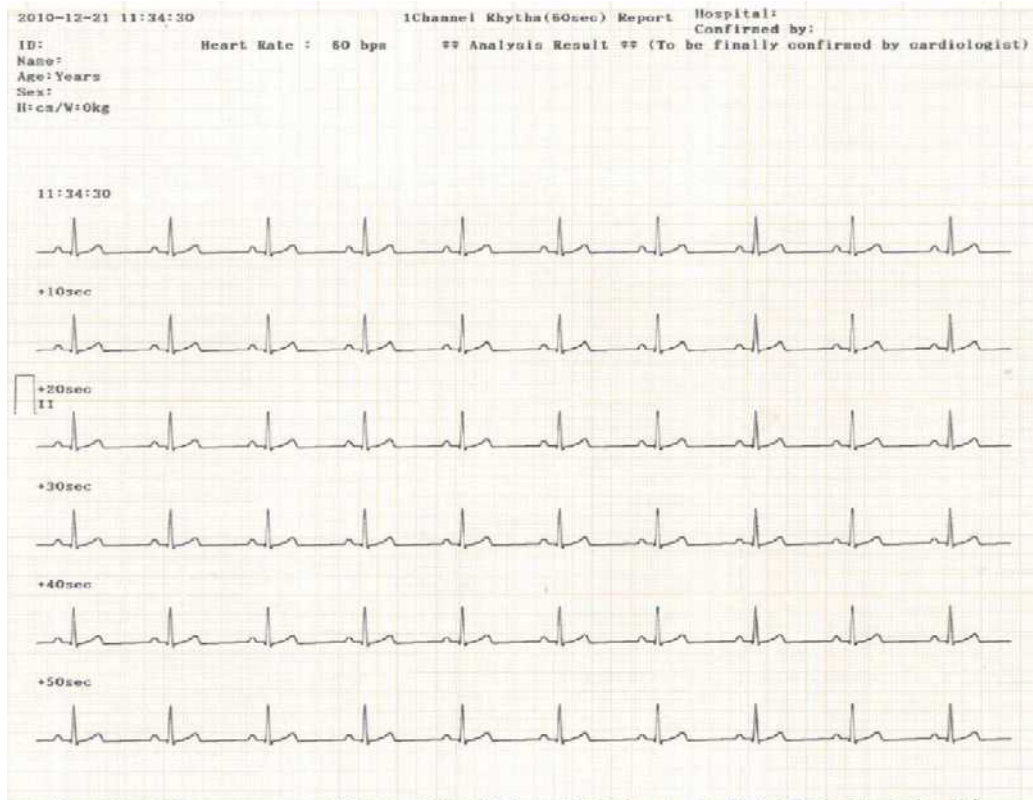

- Record Report Form (5 min. 1rhy)

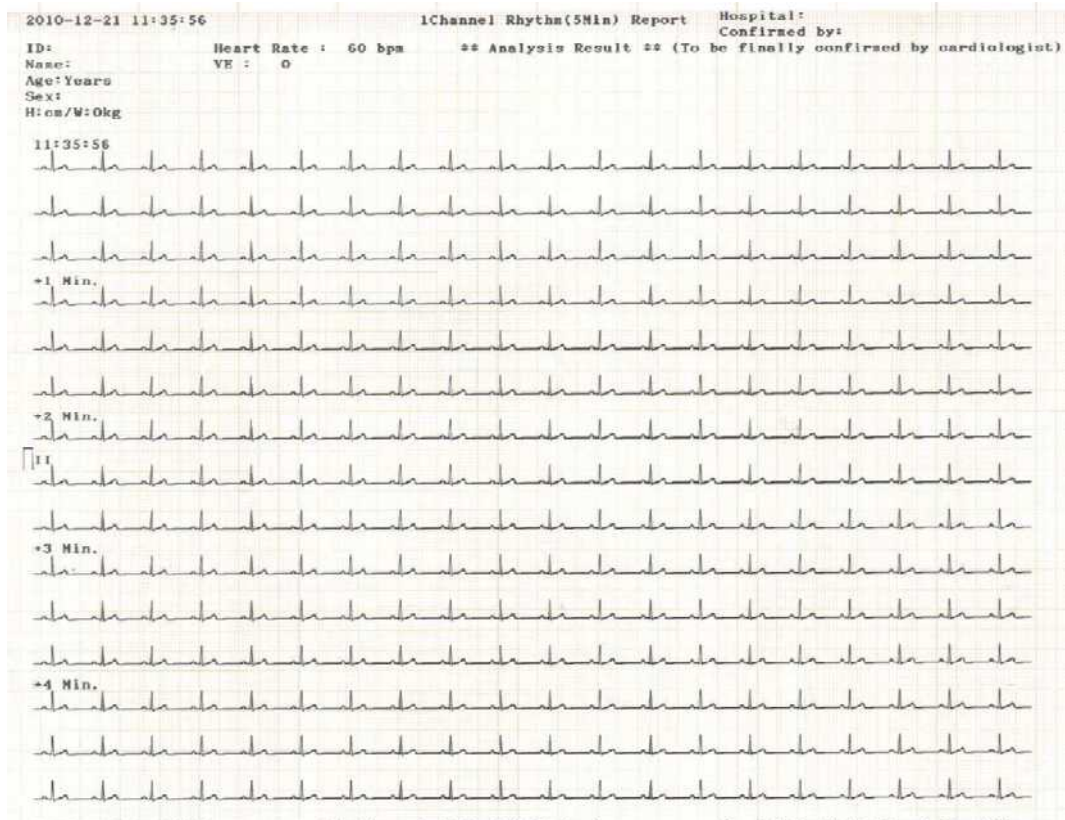

- Record Report Form (Beat Report)

Cardio-M Plus Operation Manual

2010-12-21 11:44:59

Representative Beat Report

ID:	PR	PA	PB	QA	QB	RA	RB	SA	SB	QLRD	QRSD	QRSA	TA	STA	QTc	
Name:	I	182	78	108	0	0	525	48	0	0	0	78	525	131	-24	379
Age: Years:	II	178	127	106	-63	24	888	48	-100	22	0	82	988	205	-26	384
Sex:	III	182	50	108	0	0	261	38	-70	30	0	78	331	76	-12	379
H:cm/W:kg	aVR	182	-101	108	-754	42	70	22	0	0	0	78	824	-164	19	379
Heart Rate : 60 bpm	aVL	182	16	108	0	0	173	50	0	0	0	78	173	22	9	379
	aVF	178	88	106	0	0	571	40	-92	28	0	82	663	139	-19	384
	V1	178	89	106	-65	22	190	22	-471	36	0	82	661	93	2	384
	V2	182	87	108	-65	22	380	26	-820	36	0	78	1200	227	-9	379
	V3	178	123	106	0	0	817	36	-588	30	0	82	1405	318	-19	384
	V4	178	134	108	0	0	1005	40	-263	28	0	82	1268	259	-12	384
	V5	182	130	108	-75	22	961	46	-129	24	0	78	1090	195	-12	379
	V6	178	74	106	-58	24	566	44	-80	26	0	82	646	138	-7	384

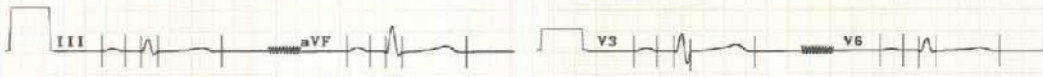
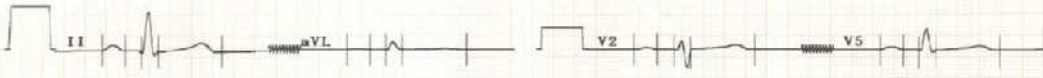
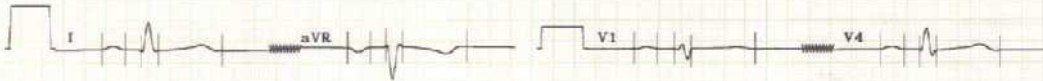

* Beat Report Parameters

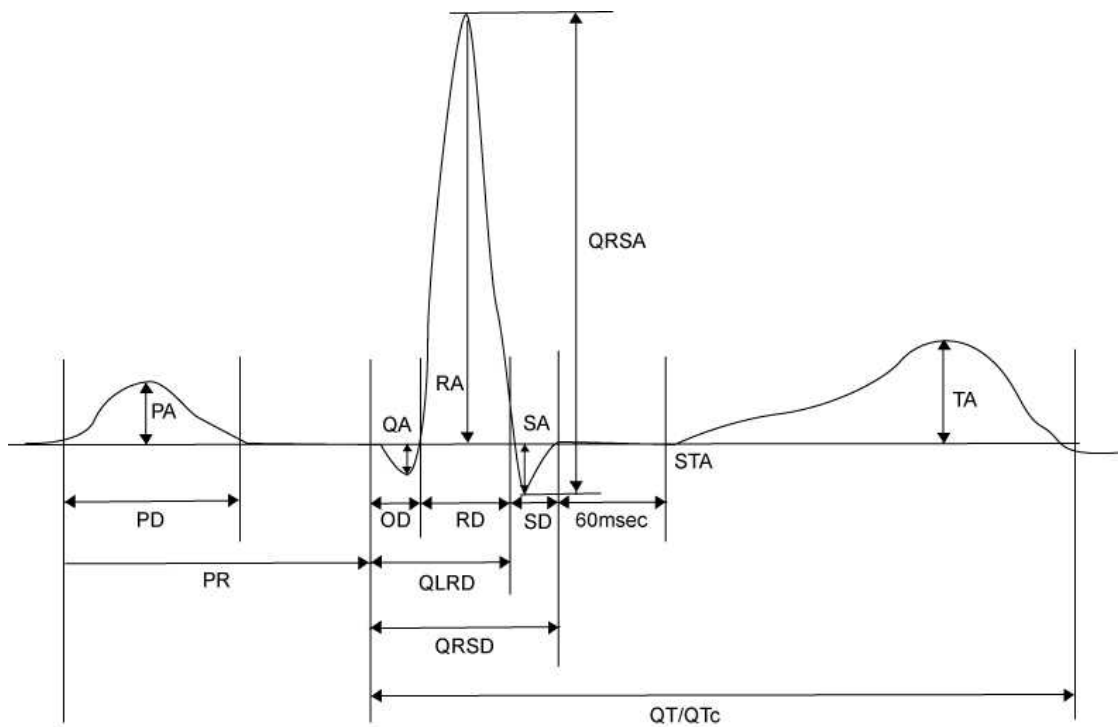

PR: PR Interval

PA: P Amplitude

PD: P Duration

QA: Q Amplitude

QD: Q Duration

RA: R Amplitude

RD: R Duration

SA: S Amplitude

SD: S Duration

QLRD: Duration Between Q And Last R

QRSD: QRS Duration

QRSA: QRS Amplitude

TA: T Amplitude

STA: ST Amplitude

QTc: Collect Q-T Interval

7) Copy Mode Printing

Copy Mode Printing is a function to print out the same report as the previously printed report. In Copy Mode, users can also print out the same previous data but with changed settings such as filter type, sensitivity, printing speed, channel form, and rhythm number if more than one rhythm is recorded.

Copy Mode can be entered by pressing the COPY (Ⓞ) key following an EKG recording. After pressing the COPY Key, the following message will be displayed on the LCD screen, and the printing process will start:



If Copy Mode Printing is called without performing an EKG recording, there would be no EKG data to copy. In this case, the following message box will be displayed for 1 second, followed by the setup status of the system being displayed:

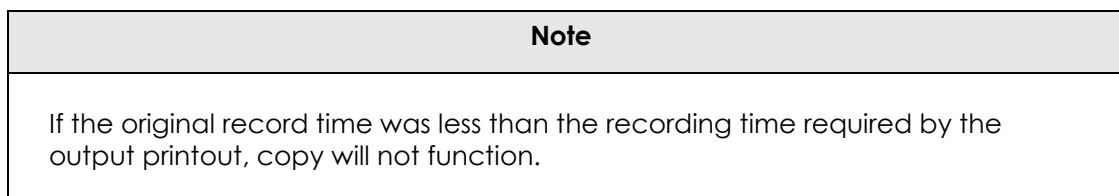

If you change the filter setup from the previously saved EKG data, the following message will be displayed with the changed filter being applied:



When the filter application is completed, the following message will be displayed, and the printing process will start:

Cardio-M Plus Operation Manual

SYSTEM MESSAGE

Printing...

If the device encounters a problem before it finishes printing, the following message will be displayed for 1 second before returning to previous menu:

SYSTEM MESSAGE

Abnormal End!

Press the PAUSE (⏸) key in order to abort the printing. Once printing is stopped, the following message will be shown for one second on the LCD screen before returning to the previous menu:

SYSTEM MESSAGE

Process Canceling...

8) Device Setup

Device Setup consists of Basic Setup, Network Setup and Hospital Setup main menus. Preferences for each main menu item can be set by navigating menus representing each section. Upon entering the Device Setup Menu, users will see the Basic Setup menu highlighted. After selecting preferences for all desired sections, press the Ok button to apply and the Cancel button to abandon the setting. To exit from Device Setup, press the NET/ESC key on the control panel or select Exit section.

Basic Setup

Basic Setup consists of Date, Time, Touch screen (Touch Setup), Unit, Language, Save, Screen, Filter, QRS, P/M, L/F, Line, Demo and QikPrint menus. Use the rotary key or touch screen to select a desired menu item, which would then open its submenu to allow the user to enter the desired input values.

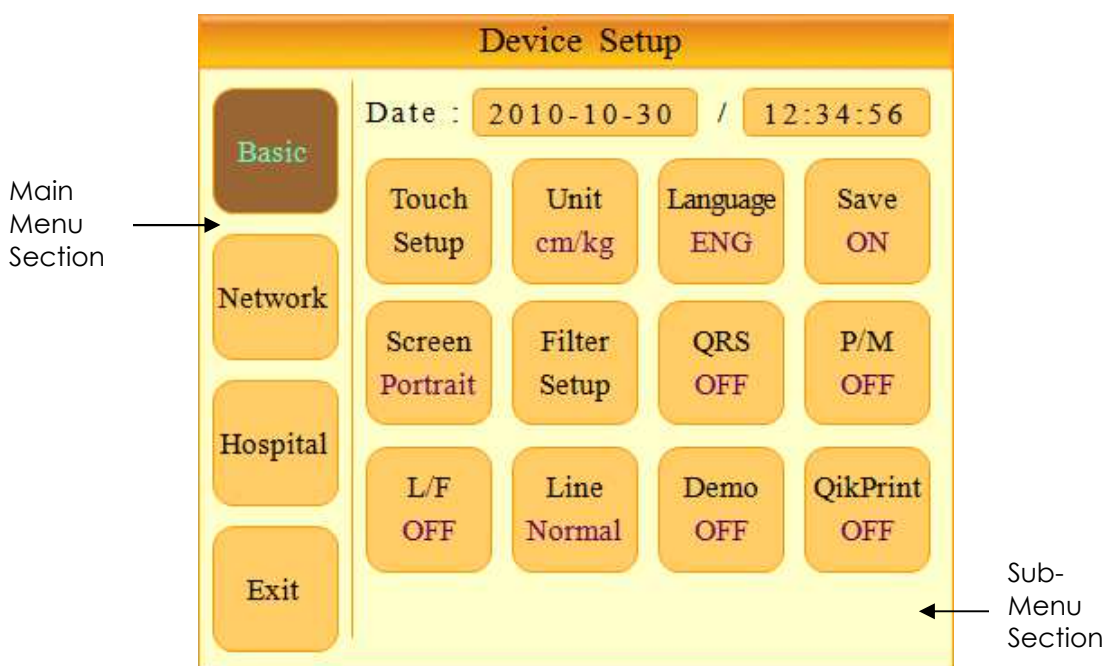

To save a modification after setting values in each submenu, select OK. To abandon changes, select Cancel.

After selecting either OK or Cancel, the screen will go back to the Device Setup view.

The NET/ESC () key will function the same as the Cancel button.

Cardio-M Plus Operation Manual

① Setup Date And Time

You can set the month, date, hour, minute and second information using the rotary key in Date/Time menu. (Touch screen functionality update planned)

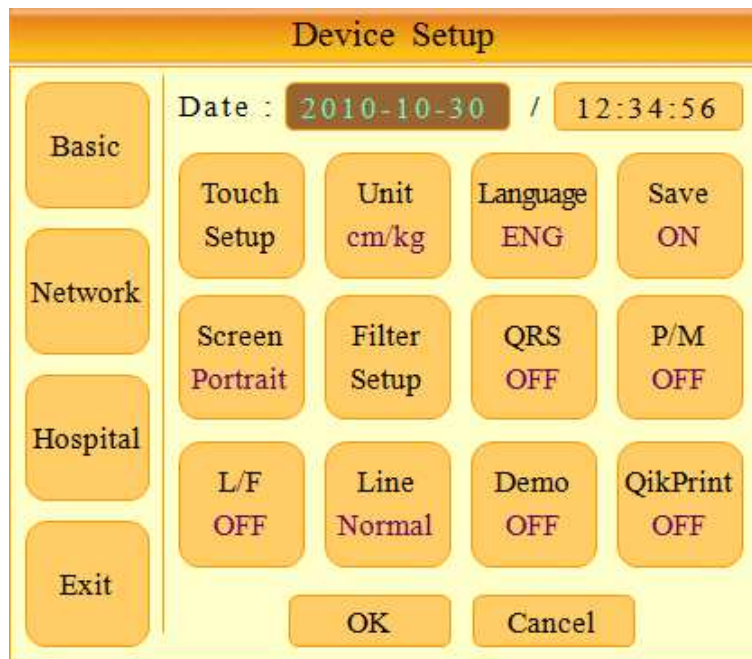

② Touch Setup

You can calibrate the touch screen by setting the coordinates.

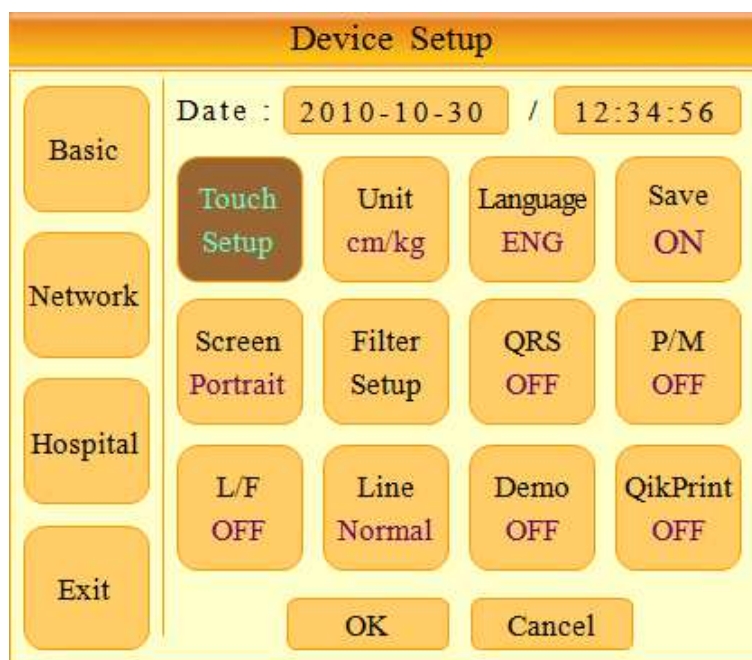

Cardio-M Plus Operation Manual

Note

When the user selects the Touch Setup menu, all windows will disappear and the touch screen setup will start. No keys will be operational until the Touch Setup is complete.

③ Unit

You can set units of height and weight information in Cardio M Plus. Currently, users can choose between metric and U.S. standard units; cm/Kg and in/lb



④ Language

You can set up the language for displaying and printing in Cardio M Plus. You can choose languages among ENG(English), ENG_US(Capital letters printing), CHI(Chinese), GER(German), FRE(French), RUS(Russian), SPA(Spanish), ITA(Italian), TUR(Turkish), POL(Polish), ROM(Romanian) and POR(Portuguese).

Note

When ENG_US is selected, printing paper will be set to lettered(280mm) from A4.

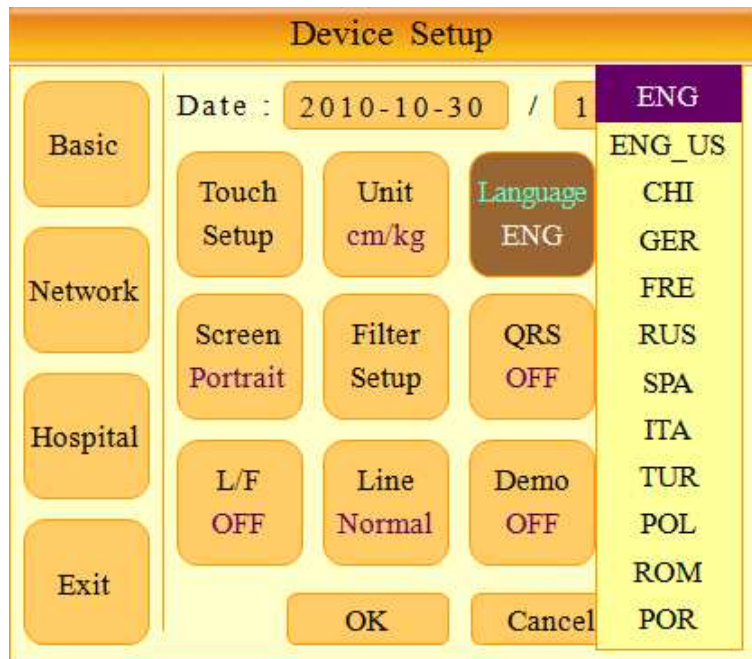

Ⓢ Saving

In this menu, users can decide whether a message box to ask the user about saving data should appear or not. If ON is selected, there will be a message box asking users about saving data. If OFF is selected, the message box will not appear and no data will be saved.



Cardio-M Plus Operation Manual

⑥ Screen Mode Setup

For screen mode, users can choose either portrait or landscape layouts.

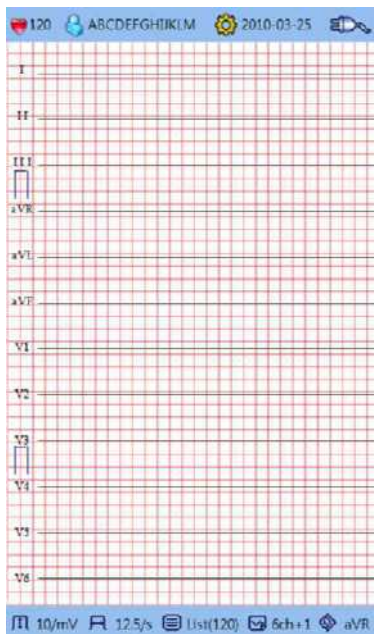
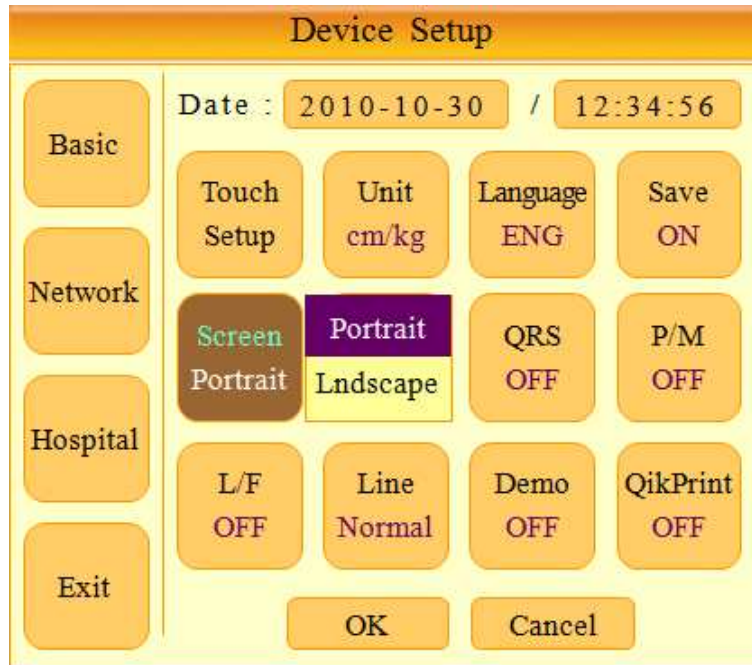

< Portrait Mode >

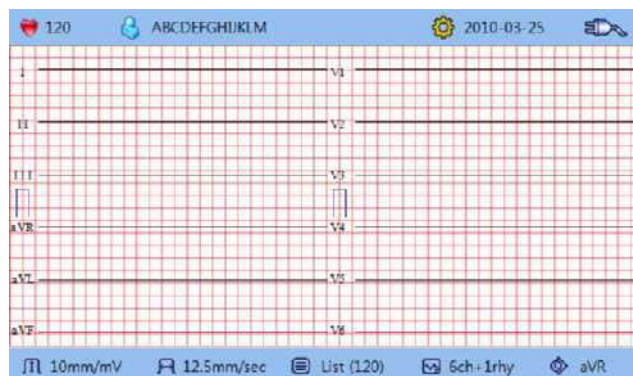

< Landscape Mode >

⑦ Filter Setup

Cardio-M Plus Operation Manual

The signal output generated by the device may contain extra unwanted signals in addition to the EKG wave such as AC noise, base line drift caused by respiration, noise generated by an electrical field nearby, etc. Applying filters could help to reduce or remove those unwanted signals from the output of the device.

To change filter information, enter the Filter Setup Menu either by moving the selection block over and select it using the rotary key or by touching the menu on the touch screen.

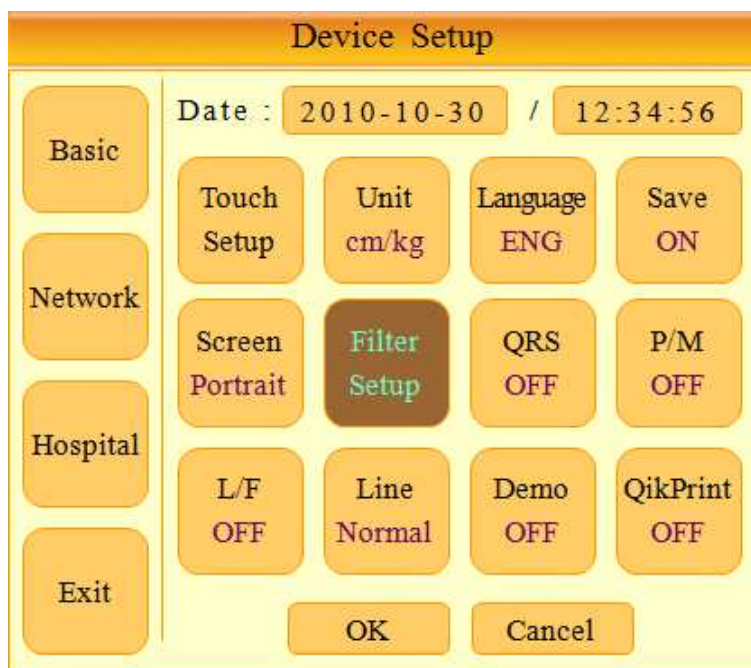

Upon selection, the Filter Setup menu, shown below, will appear. Use either the rotary key or touch screen to navigate and select menu items to edit. After editing, OK must be selected in order to apply the changed value.

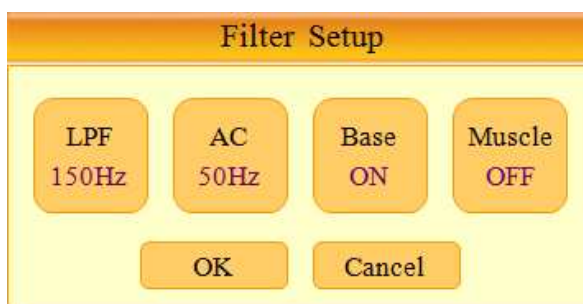

If the recorded EKG signal contains a lot of noise, Low Pass Filter (LPF) may help to clear it. For Low Pass Filter, 40Hz, 100Hz, 150Hz and OFF option is offered. Here, 40Hz option means the filter will remove any unwanted signal with frequencies above 40Hz. Low Pass Filter values will appear on the bottom of the printout form; if LPF setting is OFF then as ~250Hz; if the LPF setting is 40Hz then as ~40Hz; if LPF setting is 100Hz then as ~100Hz; if LPF setting is 150Hz, then as ~150Hz.

Cardio-M Plus Operation Manual



There are three types of an AC power noise filter; 60Hz, 50Hz and OFF. When set to OFF, the filter will not be applied. If the filter is set to 50Hz or 60Hz, then the AC filter will remove 50Hz or 60Hz power noise correspondingly. In the U.S., the AC filter should be set to 60Hz. Check the properties of your power source before setting AC filter properties.

Under battery power, there would be no AC noise being generated. In this case, please set the AC filter setting to OFF so that output signal would not be distorted.

The status of the AC filter can be checked on the bottom part of the printout - indicating AC 60Hz, AC 50Hz or AC OFF.

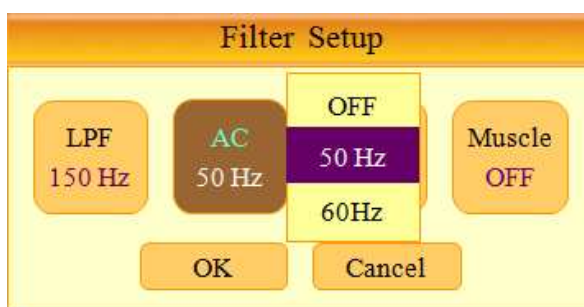

Base line drift is caused by the patient's breathing. It can be seen as ECG signals being overlapped on a large parabola. To remove Base line drift from EKG printouts, select ON. Otherwise, select OFF. The set value will appear on the bottom part of the printed form indicating 0.1HZ- when set to ON, and 0Hz- when set to OFF.

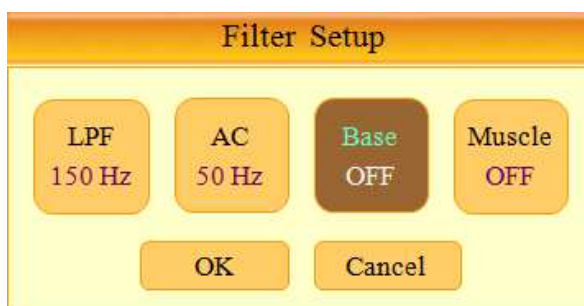

Electromyogram is caused by the patient's organs or muscle parts. When the ECG is recorded on patients with strong electromyogram responses, the ECG output

Cardio-M Plus Operation Manual

may not be clear. In Cardio M Plus, electromyogram can be eliminated by using the Muscle Filter. Select ON to apply the filter to the output and OFF to get the unfiltered output. When you switch on the filter, EMG is indicated on the bottom of the printed form.



The use of filters can distort the original output. Therefore, you may reduce the possibility of signal distortion, if you set the filters OFF when the signals are clear. For your reference, we recommend that Baseline and AC filters be set to ON most of the time. Use of the electromyogram filter should depend on signal conditions. When there is a lot of noise in the output, it is recommended that the LPF filter be set to 40Hz.

③ QRS Sound Setup

In this menu, users can set the device to ring an alarm sound when a QRS beat has generated while it is in waiting mode. Users can either set the alarm ON or OFF by selecting the menu with ON turning on and OFF turning off the alarm sound.

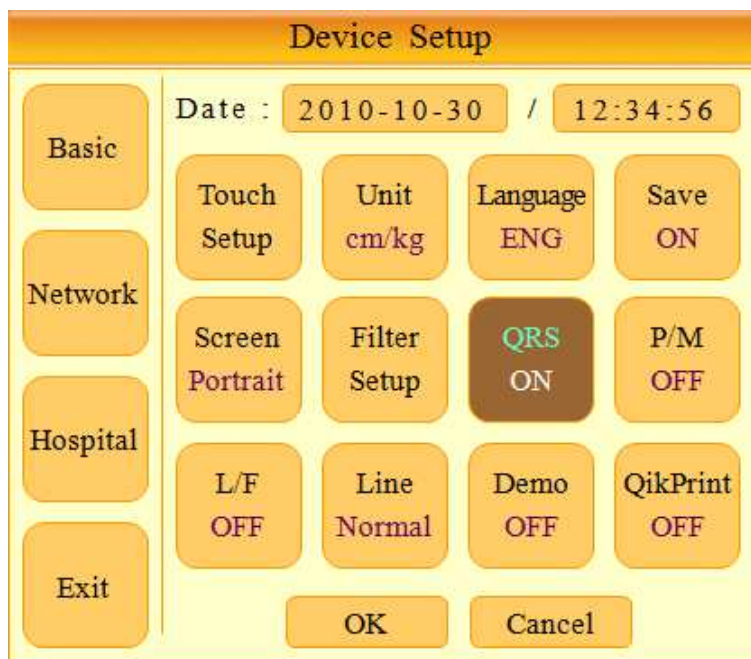

Note

No sound will ring while printing even when the QRS sound is set to ON.

① Pacemaker Signal Display Setting

When a signal from the patient's pacemaker is registered by Cardio M Plus, users can set whether to print location of the pacemaker device in rhythm and diagnostic printing modes or not. In [P/M] menu within the Device Setup, users can set it to either ON or OFF. ON for placing the pacemaker location on the printout, and OFF for disabling the pacemaker location print.

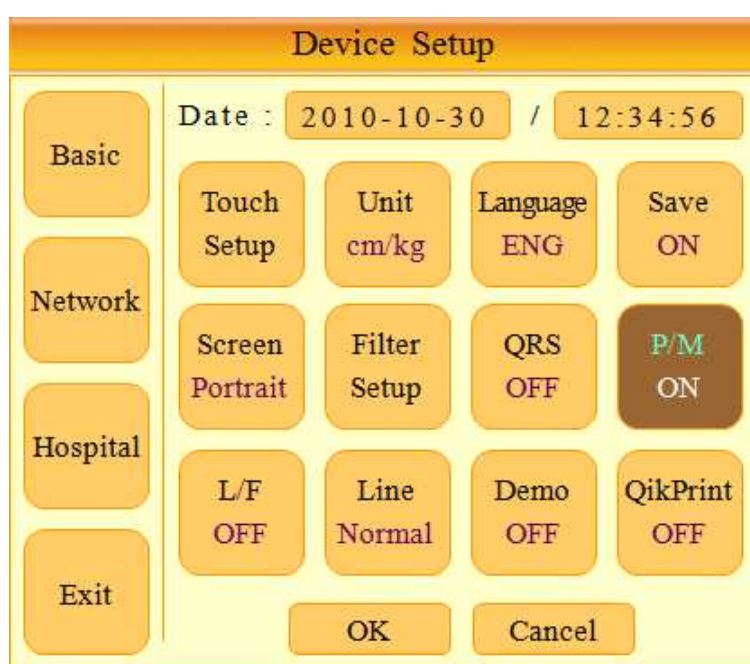

Note

We recommend that [P/M] be set to OFF in normal conditions and ON when measuring the EKG of patients with a pacemaker.

② Lead Fault Signal Display Setting

When there is a Lead Fault event, this setup sets whether the "Lead Fault" message will be displayed on the LCD screen of the device or not.

Selecting [L/F] menu will switch between ON and OFF in the menu, with ON turning on the message display and OFF switching off the message display.

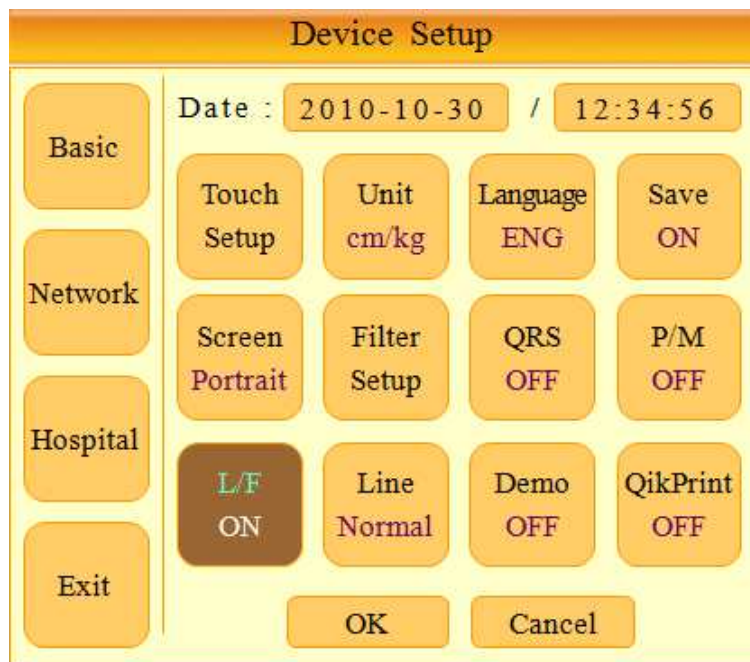

The following message for Lead Fault will be shown with affected channels:

Lead Fault! All Leads.

Note
<ul style="list-style-type: none">- If the RL lead becomes faulty, the device will display a message saying all leads are faulty ("Lead Fault! All Leads.")- If a Lead Fault occurs during monitoring or recording, a buzzer alarm will sound and the message box will pop up.- No pacemaker signal may be detected. Additionally, if a Lead Fault occurs, please re-measure the EKG as it could have affected the measurement by the device.

③ Line Thickness (Printing) Setting

This menu sets the thickness of lines in printouts. Thin indicates thin lines, Normal is regular thickness, and Thick is bold lines.

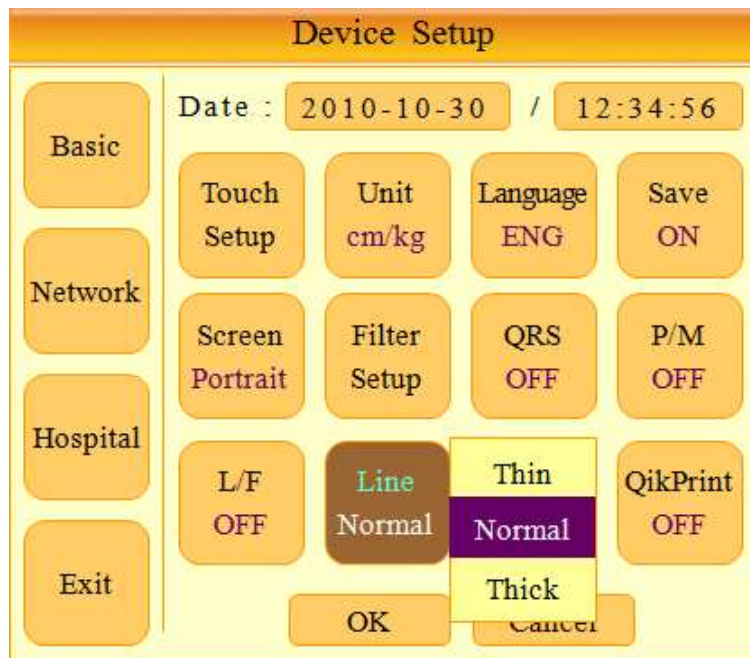

④ Demo Mode Setting

This menu puts Cardio M Plus in demo mode. When it is set to ON, 60bpm Sinus Normal Rhythm signal will be displayed on the device and DEMO sign will appear on the upper part of the LCD screen. Users can test rhythm, diagnostic, copy printing functions as well as PC communication and other miscellaneous functions in Cardio M Plus.

Cardio-M Plus Operation Manual

Device Setup

Basic	Date :	2010-10-30	/	12:34:56
	Touch Setup	Unit cm/kg	Language ENG	Save ON
Network	Screen Portrait	Filter Setup	QRS OFF	P/M OFF
Hospital	L/F OFF	Line Normal	Demo ON	QikPrint OFF
Exit	OK		Cancel	

Cardio-M Plus Operation Manual

Ⓢ QikPrint (Quick Printing) Setting

In this mode, users can choose to set or cancel the QikPrint rapid printing function. When the function is ON, Cardio M Plus will save printing time by utilizing 5-second buffering.



Note

- When the ON setting is used, you should operate by pressing the Diagnostic Printing button after the signal is stabilized. The device will utilize data from 5 seconds prior to button pressing for the function, which means diagnostic information and output printout will be negatively affected if the signal is unstable.
- QikPrint(Quick Printing) setting only affects 10-second recording modes. It will not function on neither 60-second, nor 5-minute recording modes.

Network Setup

In Network Setup, users will be able to set network information for the device. Neither automatic IP address assignment nor DNS setup functionalities are supported by the Cardio M Plus.

The IP Address field sets a unique IP address, which is assigned to the device by the hospital's network provider. In the DB server field, users can enter the IP address of the PC/Workstation where EKG data from the device will be transmitted to (i.e., IP address of the PC where BMS Plus software that can receive EKG information from device and store has been installed). For subnet mask and gateway field, usually the same information from the DB server can be entered.

The screenshot shows a 'Device Setup' dialog box with a yellow background. On the left side, there are four vertical buttons: 'Basic', 'Network', 'Hospital', and 'Exit'. The 'Network' button is currently selected. The main area of the dialog is titled 'TCP/IP Network Address' and contains four input fields with orange borders. The first field is 'IP Address' with the value '192.168.30.127'. The second field is 'Subnet Mask' with the value '255.255.255.0'. The third field is 'Gateway' with the value '192.168.30.1'. The fourth field is 'DB Server' with the value '192.168.30.74'. At the bottom of the dialog, there are two buttons: 'OK' and 'Cancel'.

Field	Value
IP Address	192.168.30.127
Subnet Mask	255.255.255.0
Gateway	192.168.30.1
DB Server	192.168.30.74

* Network information can only be entered using the rotary key.

Hospital Setup

Enter names of the hospital (clinic) and attending doctor which will be recorded and printed along with the EKG data.

The screenshot shows a software interface titled "Device Setup". On the left side, there is a vertical menu with four buttons: "Basic", "Network", "Hospital", and "Exit". The "Basic" button is currently selected. The main area of the screen is titled "Hospital & Doctor Name" and contains two input fields. The first field is labeled "Hosp. Name" and the second is labeled "Dr. Name". At the bottom of the screen, there are two buttons: "OK" and "Cancel".

9) Network Functions

Any previously acquired or newly taken measurements from the device can be transmitted to the server PC/workstation for comprehensive data management.

(1) Entering Patient Information



In order to transmit patient data from the device to a PC/workstation, patient information should be entered first. Note that the patient ID must be entered as it is a required input value for network functions.

(2) Sharing EKG Data Without Printing

While in the EKG Main screen, pressing the NET/ESC () key after entering the patient's ID will trigger a message box with text "Send new record data?" will appear. Select Yes, if one wishes to take a new EKG measurement then transmit; select No to transmit any previously recorded EKG recordings; select Cancel to abandon data transmission.

If Yes is selected, the device will go through Recording → Analyzing → Sending processes as the data gets transmitted to the server PC/workstation. If No is chosen, the previously recorded data will be sent to the server PC/workstation without going through the Recording and Analyzing processes.

(3) Transmitting Saved Data

After printing the EKG data by pressing RECORD () button and saving the data to the device, the saved data can be transmitted to the PC/ Workstation. Select () from the bottom of the EKG Main screen. Pressing the NET/ESC () key will trigger the device to transmit data to the PC/workstation, when the Data Management screen appears. For guides in managing acquired data, you should refer to the "10) Data Management Screen" section.

- Data transmission to a PC can only occur while the server program on the PC is running. Therefore, please check to make sure the server program on the PC is in operation before pressing the Communication/Pause key on the device.
- If the size of the data for transmission is too large, it may take longer (more than a minute) than usual.
- A transmission error could happen if the network communication is disrupted, while transmitting the data to the PC. In this case, the device will display a "Transmission Error" message first, then attempt to resend automatically 1 time and complete the transmission as long as the network disruption does not reoccur. However, if the disruption continues, the user will have to press the Communication/Pause key again to manually initiate the data transmission. If the problem persists, the EKG device may have to be turned off then on to perform data transmission.
- When transmitting multiple sets of data to the PC after saving, a network error could occur which may cause transmission halt and subsequent loss of data. Therefore, we recommend users practice the following procedures to minimize such loss:
 1. In the EKG Main, press the NET button to transmit data to the PC immediately after measuring.
 2. When transmitting multiple sets of measurements, rather than sending all data at once, we recommend users transmit individual data after each measurement.

10) Data Management

(1) Window And Function Description

No	ID	Name	Data/Time	Type
1	0123456789	Jun Chang	10/10/10 12:30	ECG
2	1111111111	Hyonok Lee	10/10/10 13:30	ECG
① → 3	777	Yountae Im	10/10/10 14:30	ECG
4	987654321	Sunho Ryu	10/10/10 15:30	ECG
5	kkk	Namha Lee	10/10/10 16:30	ECG
6	abcdefg	Chris Oh	10/10/11 12:30	FVC
7	abcdefghijklm	Jay Shim	10/10/12 12:30	FVC+
8	1	Paul Lee	10/10/13 12:30	SVC
9	12	Jongeun Song	10/10/14 12:30	MVV
10	123	Dongju Kang	10/10/15 12:30	ECG
11	1234	Minsang Yoo	10/10/16 12:30	ECG
12	12345	Jongpil Chae	10/10/17 12:30	ECG
13	123456	Kyungsup Bang	10/10/18 12:30	FVC
14	1234567	Giyoung Lee	10/10/19 12:30	SVC
15	12345678	Jeail Kim	10/10/20 12:30	MVV
16	123456789	Hyewon Choi	10/10/21 12:30	FVC+
17	1234567890	Jeonghyon Kim	10/10/22 12:30	ECG
18	12345678901	Cheonho Choi	10/10/23 12:30	ECG
19	123456789012	Seung Kim	10/10/24 12:30	FVC
20	1234567890123	Youngwoo Park	10/10/25 12:30	FVC

←←
→→
3/120
ECG
INFO
DEL
PRT

↑
↑
↑
↑
↑
↑
↑

②
③
④
⑤
⑥
⑦
⑧

- ① Currently Selected Data
- ② Previous Page
- ③ Next Page
- ④ Current Cursor Position/Number Of All Data.
- ⑤ Previous Menu (Shown As ECG or SPR) – Show Menu Prior To Entering Data Management Screen
- ⑥ Display Information Of Highlighted Patient
- ⑦ Delete Highlighted Data From The Device
- ⑧ Print Highlighted Data

* When you move to the right or left with the rotary key at the first or last data, data will be shown per page.

Cardio-M Plus Operation Manual

* When you select Info, Delete or Print with no data saved, the following message is displayed:



(2) Sending Data

With the NET/ESC () key, users can transmit saved data to a PC/workstation.

- Attempting connection to PC/workstation.



- Transmitting data to PC/workstation.



- Indicating that the data transmission is finished.



* System Message: if a connection to the PC has failed.



* System Message: if a data transmission has failed.



(3) Copying Data to a USB Flash Drive

With the 'Copy' () key, user can copy saved data to a USB flash drive.

- Copying data to a USB flash drive.

SYSTEM MESSAGE
File Copying...

- Indicating that the data copy is finished.

SYSTEM MESSAGE
File Copy Success.

- System message : if a USB flash drive is not connected.

SYSTEM MESSAGE
Please, checking the device.

- System messages : the reasons when the data copy failed

SYSTEM MESSAGE
File Copy Failed – File Busy

SYSTEM MESSAGE
File Copy Failed – Memory Full

SYSTEM MESSAGE
File Copy Failed – Protocol Fault

Cardio-M Plus Operation Manual

WARNING

When a defibrillator is used, do not touch the patient cable or apparatus.

WARNING

When you are connecting to the electrodes or the patient cable, make sure connectors never come into contact with any other conductive parts, or are grounded. In particular, make sure that all of the ECG electrodes are attached to the patient, to prevent them from contacting conductive parts or contact with ground.

WARNING

Use the provided ECG patient cable for measuring ECG in the operating room. The patient cable cannot be used for measuring respiration.

WARNING

Do not use the Cardio M Plus in combination with any Electro-Surgical (ES) equipment.

WARNING

Users must use the same type of electrode or any other electrodes with biocompatibility certification proven by one of the international standards.

WARNING

Cardio M Plus must be operated under the supervision of a health care professional, especially when it is used on a pacemaker-treated patient.

Chapter 4. System Management

- 1) Maintenance And Cleaning**
- 2) Regular Check-Up**
- 3) Trouble Shooting**

1) Maintenance And Cleaning

There are various ways to keep the Cardio M Plus clean and well-maintained. This section outlines several actions that could damage or stain the machine permanently and thus need to be avoided by operators of the device. If unapproved materials that may cause damage to the product were used, the product warranty may not be honored even though the period of guarantee may not have been expired.

WARNING

- Check main unit and electrodes thoroughly after cleaning.
- Do not use old or damaged equipment on patients!

- To keep the machine clean, apply Isopropyl alcohol (consisting of 70% solution in water) on a soft cloth and scrub the body and the measuring electrodes with the warm water once a month. Do not use lacquer, thinner, ethylene, or the oxidizing substance.
- Keep the cable from dust or stain. Wipe the cable with a cloth that is wet with warm water (40°C/ 104 F), and with Isopropyl alcohol (consisting of 70% solution in water) once a week.
- Do not soak the device and its cables into any liquid or detergent. Keep the machine and its cables away from any liquid.

Disposal Of Your Old Appliance

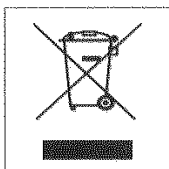

1. All electrical and electronic products should be disposed separately from the municipal waste stream via designated collection facilities appointed by the government or the local authorities.
2. Correct disposal of your old appliance will help prevent potential negative consequences for the environment and human health.

3. For more detailed information about disposal of your old appliance, please contact your local government office, waste disposal service or local distributor where the product was purchased.

2) Regular Check-Up

Perform the safety inspection on the Cardio M Plus periodically (at least once a year). See the service manual (provided by Medical Econet GmbH upon receipt of written request) for details on the inspection of Cardio M Plus.

3) Trouble Shooting

(1) When nothing or blurred out lines are being printed, during print out operation.

→ The upper cover of the printer may not have been closed properly. Check and close the upper cover completely before using the machine.

(2) When the device is powered by the battery instead of AC power, the buzzer rings for three times consecutively and the following message is displayed on the screen:

SYSTEM MESSAGE

Battery Low

→ The battery is almost used up. Connect the AC power supply in order to continue operating the machine.

(3) When the device is printing EKG results, there is a lot of noise added to the signal:

→ Check whether the AC power supply filter is set up properly. If it is still noisy, even though the AC power supply filter is ON, connect the ground wire to the GND electrode of the system. Do not use the GND with that of AC power supply. Instead, connect GND to the patient's bed or any other metal around the device that is connected to the building's wall.

* If you continue to have problems even after following the aforementioned points, or other problems that are not mentioned above, contact Medical Econet GmbH's customer service.

Chapter 5. Specification

ECG leads	12 standard leads, acquired simultaneously and continuously
Dimension	296(W) x 305.5(H) x 92.5(D)mm, approx. 3.5kg
Recording channel	3, 6, 12 channels 10 second recording and beat report 1 channel 60 second or 5 minute recording
Sensitivity	2.5, 5, 10, 20, auto (I~aVF: 10, V1~V6: 5) mm/mV
Printing speed	12.5, 25, 50 mm/s
Filters	AC (50/60 Hz, -20dB or better) Muscle (25~35Hz, -3dB or better) Base line drift (0.1Hz, -3dB or better) Low pass filter: off, 40Hz, 100Hz, 150Hz
Display	7 inch 800x480 pixel Color TFT LCD display & 12 channels preview
Monitor display	HR, ID, date, AC or battery state, sensitivity, speed, number of saved data, printing form, rhythm lead
User interface	Touch screen(alphanumeric keyboard and keypad), push button and rotary switch
Patient data	ID, name, age, sex, height, weight, race, smoke
Basic measurement	Heart rate, PR, QRS, QT/QTc, P-R-T axis
Recorder	Thermal print head, roll paper Report paper: width:A4:210mm or 8.5", length:A4:300mm or 11" Resolution: vertical: 8dot/mm, Horizontal: 16dot/mm
Electrical	Resolution: 500 sample/sec. Internal noise: 20 μ V (p-p)max Input impedance: $\geq 10 M\Omega$ Input range: $\geq \pm 5mV$ Common mode rejection: $> 100dB$ DC offset voltage: $\geq \pm 300mV$ Time constant: 3.2sec Patient leakage current: $< 10 \mu A$ Frequency response: 0.05 ~ 150Hz Isolated and defibrillation protected
Signal quality control	Disconnected lead detection, pacemaker pulse detection
ECG data storage	storage for 120 ECGs (internal on flash memory), USB key support
ECG Interpretation	Application: screening for cardiac abnormalities in the general population Population: adults, children Location: general physician's office Accuracy: high-specificity program intended for low-risk patient
Power	Power supply: AC or built-in battery(option)

Cardio-M Plus Operation Manual

	95 ~ 240 VAC, 50/60Hz, 1.0 ~ 0.5A, 60W max
Battery (Ni-MH)	1 hour of normal use (approx. 100 ECG printouts)
Communication	PC connection with RS232 interface and LAN
Safety conformity	ClassI, Type BF
Environment	Operating humidity: 30~85% Operating temperature: 10 ~ 40°C (50 to 104°F) Atmospheric pressure: 70 ~ 106KPa
Standard accessory	Power cord 1 ea., patient cable 1 ea., limb 1 set(4 ea.), chest ball 1 set(6 ea.), chart paper 1 ea., operation manual 1 ea.
Options	Rechargeable battery, cart, hanger

WARRANTY

Product Name	Electrocardiograph
Model Name	Cardio M Plus
License Number	
License Date	
Serial Number	
Warranty period	2 years from the date of purchase
Date of purchase	
Customer	Hospital: Name: Address: Contact No:
Seller's Name	
Manufacturer's Name	

- ※ Thanks for purchasing Cardio M Plus.
- ※ This product is a medical machine.
- ※ This product meets the strict quality requirements thoroughly.

International Sales & Service

Medical Econet GmbH

Mainstr. 6 c-d

45768 Marl

Germany

www.medical-econet.com

Medical Econet GmbH

Model Name: Cardio M Plus