

BTL-4000 Topline Magnetotherapy

USER'S GUIDE



100IE20/12/2007

CONTENTS

1.	MAGNETOTHERAPY	4
2.	MAGNETOTHERAPY – PHYSICAL BACKGROUND	5
2.1	Magnetic Field	5
2.1.1	Stationary Magnetic Field.....	6
2.1.2	Alternating Magnetic Field.....	6
2.1.3	Pulse Magnetic Field.....	6
2.2	FMF Technology.....	7
2.3	Magnetic Field Units	8
3.	THERAPEUTIC EFFECTS OF MAGNETOTHERAPY	10
3.1	Analgesic Effect.....	10
3.2	Antiphlogistic Effect	10
3.3	Trophic Effect	11
3.4	Myorelaxation and Spasmolytic Effect.....	11
3.5	Vasodilatation Effect.....	11
3.6	Antiedematous Effect.....	11
4.	RECOMMENDED DOSAGE OF MAGNETOTHERAPY	12
5.	BIBLIOGRAPHY	13
6.	SETTING AND CONTROL OF MAGNETOTHERAPY – TECHNICAL PARAMETERS .	16
6.1	Magnetic Field Intensity	16
6.2	Therapy Duration	16
6.3	Physiological Effects.....	16
6.4	Selection of Therapy.....	16
6.4.1	Magnetic Pulses.....	17
6.4.2	Series of Magnetic Pulses.....	17
6.4.3	Continuous Magnetic Field.....	18
6.5	Pulse Shape	18
6.5.1	Rectangular Pulses.....	19
6.5.2	Rectangular Protracted Pulses	20
6.5.3	Exponential Pulses.....	21
6.5.4	Sinusoidal Pulses.....	21
6.5.5	Triangular Pulses	22
6.6	Modulation	22
6.6.1	Random Frequency.....	22
6.6.2	Burst.....	22
6.6.3	Sine Surges	23
6.6.4	Trapezoid Surges.....	23
6.6.5	Symmetric Surges.....	24
6.7	Test of Connected Applicator	24

7.	APPLICATORS	25
7.1	“Disc” Applicator	25
7.1.1	Technical Parameters	25
7.1.2	Shape of the Magnetic Field of the Applicator.....	26
7.2	“Double Disc” Applicator	27
7.2.1	Technical Parameters	27
7.2.2	Shape of the Magnetic Field of the Applicator.....	28
7.3	“Multi Disc” Applicator	29
7.3.1	Technical Parameters	29
7.3.2	Shape of the Magnetic Field of the Applicator.....	30
7.4	“Solenoid 30” Applicator	31
7.4.1	Technical Parameters	31
7.4.2	Shape of the Magnetic Field of the Applicator.....	31
7.5	“Solenoid 60” Applicator	32
7.5.1	Technical Parameters	32
7.5.2	Shape of the Magnetic Field of the Applicator.....	32
7.6	“Linear” Applicator	33
7.6.1	Technical Parameters	33
7.6.2	Shape of the Magnetic Field of the Applicator.....	33
7.7	“Solenoid 70” Applicator	34
7.7.1	Technical Parameters	34
7.7.2	Shape of the Magnetic Field of the Applicator.....	34



1. MAGNETOTHERAPY

Magnetotherapy is one of the basic physiotherapy procedures. Its basic form - application of a static magnetic field, i.e. a permanent magnet - has been used since time immemorial as one of the natural healing sources. However, only the coming of electronics and powerful switching elements enabled the rapid development of low-frequency pulse magnet therapy, the effects of which are several times greater than those of the static magnetic field. Recently performed studies imply that therapy performed by means of pulse electromagnetic field is up to 100 times more effective than the application of a stationary magnetic field. That is why pulse magnetotherapy is becoming one of the most widespread physiotherapy methods nowadays. In some conditions (e.g. chronic pains in degenerative articular diseases) this method has proven successful as therapy with long-lasting therapeutic effect even when other therapy methods failed.

Pulse magnetotherapy can be very effective in case of correct indication and application. It can also be recommended for use in combination with other therapy methods, such as pharmacotherapy, the effects of which are usually supported by magnetotherapy. That is why magnetotherapy should neither be left out in case of a comprehensive approach to treatment, nor given preference as monotherapy.

The latest findings about the physiological response of the body to the electromagnetic field imply the following effects of magnetotherapy:

- analgesic effect,
- antiedematous effect,
- antiphlogistic effect,
- trophic effect (acceleration of healing and growth),
- myorelaxation and spasmolytic effect,
- vasodilatation effect.

The following chapters contain a brief explanation of the physical background of magnetotherapy and the physiological mechanisms of its effect with the emphasis on application in individual fields of medicine.

The Encyclopaedia, which is a separate attachment to this User's Guide, contains a list of recommended parameters of magnetotherapy in selected diagnoses.

The design of this device utilizes the experience acquired during the development, manufacturing and long-standing clinical operation of the **BTL-09** device and state-of-the-art devices in the **BTL-4000** and **BTL-5000** series.

During the design of new magnetic applicators for this device, there was developed a brand new technology – so-called “**FMF**” (“**Focused Magnetic Field**”) technology. Thus we managed to increase the electromagnetic field intensity on the patient's side and significantly reduce the electromagnetic field intensity on the applicator's side, turned away from the patient. Colloquially put, the magnetic field was moved from the improper side to the side where it is desired.

Thanks to these construction elements and thanks to state-of-the-art sources based on the principle of electronic switching elements, we have managed to reduce the power consumption significantly while preserving the same electromagnetic field intensities.

Note

The authors of this User's Guide are aware that such a small space is not sufficient for a detailed description of the entire magnetotherapy issue. They therefore had to make some generalizations and simplifications resulting from the limited scope of this text. More details can be found in the available literature (see the chapter **Bibliography**).



2. MAGNETOTHERAPY – PHYSICAL BACKGROUND



2.1 MAGNETIC FIELD

The magnetic field is an integral part of the electromagnetic field, which consists of electrical and magnetic components. Both components of the electromagnetic field are mutually closely connected and cannot exist without each other, except in the following two special cases:

- electrostatic field, in which the magnetic component of the field is zero, and
- **stationary magnetic field**, in which the electrical component is zero.

Owing to the used frequencies up to 150 Hz and owing to the design of the BTL applicators, the magnetic component of the field predominates over the electrical. In short we will hereinafter call the field by the commonly used term “magnetic field”.

The presence of a magnetic field is sensed primarily through its **force effects**, by which it affects magnetically conductive things, moving charges and conductors with electric current flowing through them. The force effects are not very important for our theory, because biological objects are diamagnetic. However, it is necessary to take these force effects into account in case of metal implants, especially those which are fixed in soft tissues and are not made of antimagnetic materials.

Another interaction between the magnetic field and matter occurs at the moment when matter is exposed to the magnetic field. At that moment, individual free molecules are orientated in such a way as to minimize the energy inside the field. In case of biological objects, these forces act against the bonds between atoms, molecules and ions in the tissues, which consequently also influence the cellular processes.

The effects important for physiotherapy are based on **electrodynamic induction**, discovered by the physicist M. Faraday in the 19th century. In practice, if you move an electric conductor in a magnetic field, voltage appears on it. If you make a closed loop of the moving conductor, electric current will flow through it. As Faraday discovered, this phenomenon also works the other way around – if the magnetic field moves or changes in the course of time (instead of the conductor), a similar effect occurs. These discoveries were only a short remove from the application of **alternating magnetic fields** in therapy.

In case of living organisms, the moving charges (the conductor moving in the magnetic field) are represented by the circulating body fluids (blood, lymph). In case of exposure to an alternating magnetic field, it refers to its individual more electrically conductive parts - the vascular bed (including circulating fluids), peripheral nerves, CNS neural paths and, last but not least, also individual ions and charges on cellular membranes.

2.1.1 STATIONARY MAGNETIC FIELD

A stationary magnetic field arises around permanent magnets but also around moving electric charges which move at a constant speed (direct current).

Electric charge may be carried e.g. by ions (electric current flowing in liquids) and electrons (electric current flowing in conductors). In the latter case, a magnetic field similar to that around a permanent magnet arises around the electric conductor with constant direct electric current flowing through it.

2.1.2 ALTERNATING MAGNETIC FIELD

The time behaviour of this field is usually derived from the sinusoidal mains voltage. In common practice, devices most often generate fields of a frequency of 50 Hz and the sinusoidal waveform. The magnetic fields of these devices change their polarity in the course of time.

These fields, even though with much lower intensity, exist in the surroundings of each electrical conductor, transformer and motor supplied from the AC mains.

2.1.3 PULSE MAGNETIC FIELD

This field is characterized by fast changes of field; individual pulses are close to rectangular pulses, their edges are very steep. That is why in a pulse magnetic field the electrical component is higher and is permanently present beside the magnetic component. Some studies, which deal with the comparison of individual magnetic field types, point out the very high efficiency of the pulse magnetic field in comparison with the stationary magnetic field. Therefore, the question arises whether the positive results of the pulse magnetic field are not caused by the more intensive electrical component of the field.

Of all the possible pulse types, the BTL – 4000 Topline device has been equipped with the following ones. These pulses cover the entire spectrum of required applications, from acute to chronic states.

• Device Options

The device can be set to generate the following pulse types:

- rectangular pulses,
- rectangular protracted pulses,
- exponential pulses,
- sinusoidal pulses,
- triangular pulses and
- continuous magnetic field.

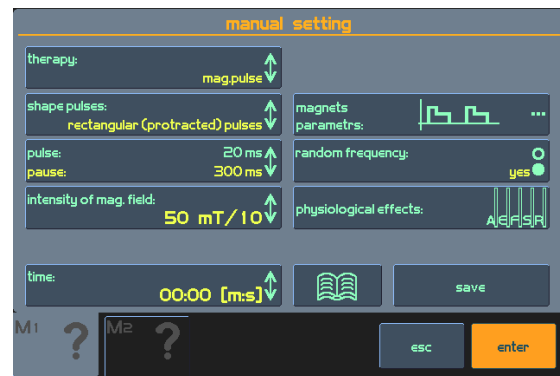

All the above listed magnetic field waveforms can be further modulated and the following surges of basic pulses can be created:

- trapezoid surges,
- sine surges,
- symmetrical surges.

It is also possible to create groups of magnetic pulses - so called **bursts**.

The option of random sweep of the basic selected frequency is available, too.

All these parameters can be set in the well-arranged manual mode. Preset programs and recommended diagnoses are available, too.



2.2 FMF TECHNOLOGY

FMF = Focused Magnetic Field

In dependence on their spatial distribution, magnetic fields are divided into **uniform** and **non-uniform**. The uniform field has the same intensity and the same direction in all points of space.

The applicators were designed using state-of-the-art ferromagnetic and magnetic materials which enable highly effective magnetic concentration systems to be assembled. These elements focus the electromagnetic field onto the desired space towards the treated body part. Therefore, the magnetic field of the BTL applicator is intentionally **non-uniform** and **focused**.

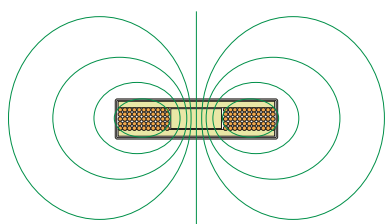

Standard Magnetic Applicator

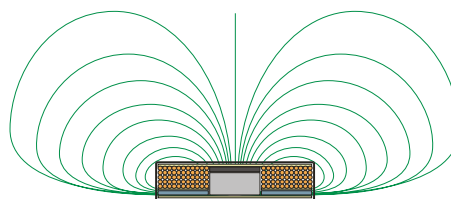

FMF Technology Applicator of DISC Type

The sides of the applicator are identified as the patient side, from which the magnetic field is emitted to a higher extent, and the operator side, where the field intensities are several times lower.

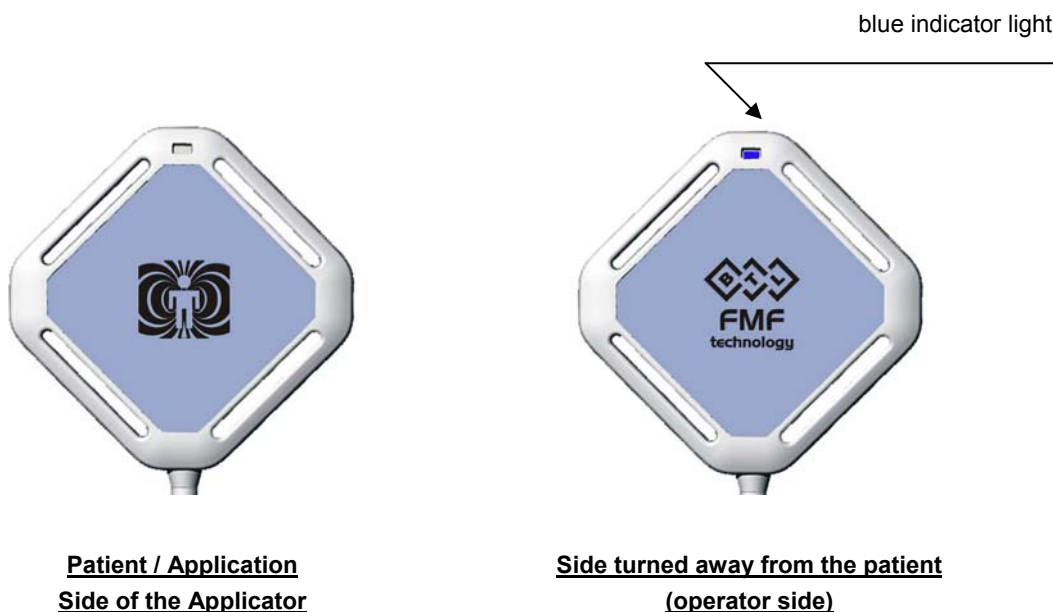

The side is marked with a pictograph of a “patient in the magnetic field”. The intensities on this side of the applicator are much higher than those on the operator’s side. During operation of the device, the operator should not touch this side of the applicator.

The side marked with the BTL logo. It is also equipped with a blue indicator lamp which indicates operation of the applicator (continuous light, fast blinking) and its readiness for operation (slow blinking).

Example of possible use of the magnetic applicator with FMF technology:

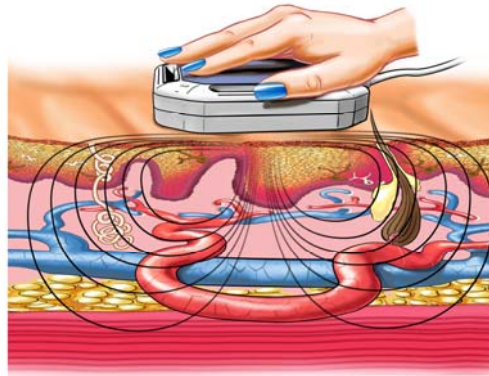

The magnetic field of the solenoid type applicators is focused inward:

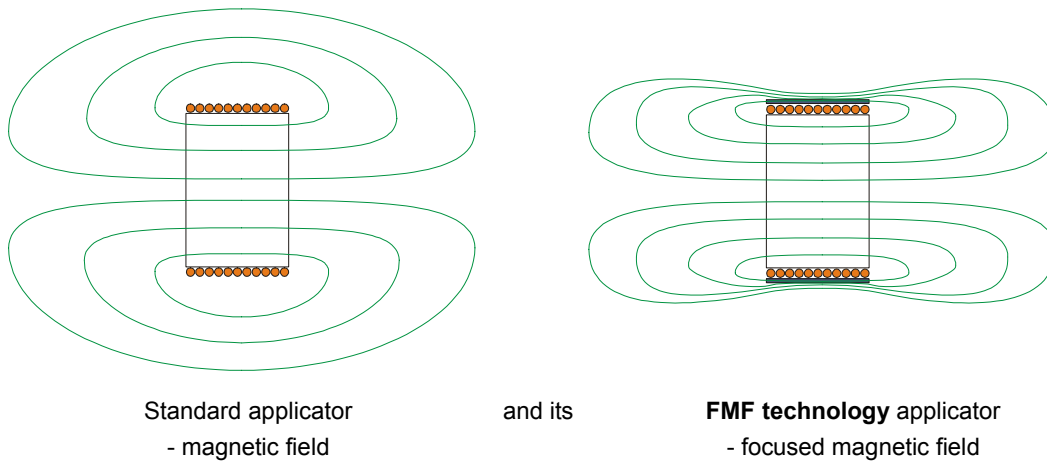

Standard applicator
- magnetic field

and its

FMF technology applicator
- focused magnetic field

2.3 MAGNETIC FIELD UNITS

The BTL-4000, BTL-4000 Topline and BTL-5000 devices use for magnetic field induction (**B**) the unit according to the SI international unit system – **Tesla (T)** or its one thousandth - **millitesla (mT)**.

Owing to the fact that the formerly used unit **Gauss (G)** has the following relation to millitesla:

1mT = 10 G, the display shows the converted value in **mT/10**.

Then, **1mT/10 = 1G**.

Other magnetic field units:

Then the unit of magnetic field intensity is **ampere per meter (A/m)**.

An older unit of intensity is **Oersted (Oe)**.

The relation between these two units is: **1 Oe = 79.577 A/m**.

The relation between magnetic induction and magnetic intensity is the following:

$$\mathbf{B} = \mu_r \cdot \mu_0 \cdot \mathbf{H}$$

where: **B** is the magnetic induction

H is the magnetic intensity

μ_0 is the permeability of a vacuum, which equals $1.2566 \cdot 10^{-6}$

μ_r is the relative permeability of the environment, which expresses the magnetic properties of the environment

- for a **vacuum** it equals **1**
- for **magnetically conductive materials**, the values are much higher than **1** (e.g. for steel, the values range from 100 to 5800)
- for **air**, the value is similar as for a **vacuum**, i.e. approximately **1** (1.00000038 to be accurate)
- **biological tissues** from this view can be compared to **water**, for which the value equals **0.999991**

It can be calculated that for biological tissues a magnetic field induction of **1mT** corresponds to a magnetic field intensity of **795.8 A/m**.

3. THERAPEUTIC EFFECTS OF MAGNETOTHERAPY

Magnetotherapy is one of the most commonly used physiotherapy procedures. This method has proved successful in some diseases as therapy with long-lasting therapeutic effect (e.g. in chronic pains of vertebrogenous aetiology or in degenerative joint diseases) even when other therapy methods have failed. However, it is necessary to consider that, like every therapeutic procedure, magnetotherapy also has a certain failure rate.

It has been proved that for the treatment of patients in acute stages it is better to use a static magnetic field at the beginning; in chronic diseases it is better to use pulse magnetotherapy. Application of magnetotherapy must always be based on a thorough medical history and detailed examination of the patient.

It is suitable to take into account that the natural magnetic field of the Earth equals approximately 0.04 – 0.05 mT (0.4 – 0.5 Gauss). The BTL-4000, BTL-4000 Topline and BTL-5000 devices work with magnetic fields, the intensity of which may be up to 1000 times higher. Therefore, the application requires particular caution, also with respect to the fact that man has no specific receptors for a magnetic field and therefore does not perceive it directly – unlike e.g. an electric current.

The latest findings about the physiological response of the body to the electromagnetic field imply the following effects of magnetotherapy:

- analgesic effect,
- antiphlogistic effect,
- trophic effect (acceleration of healing and growth),
- myorelaxation and spasmolytic effect,
- vasodilatation effect,
- antiedematous effect.

3.1 ANALGESIC EFFECT

The analgesic effect of magnetotherapy applies in most algesic states of muscular as well as articular aetiology. A detailed description of this effect is quite complicated; its physiological effects have been specified in recent years. According to these findings, the analgesic effect of magnetotherapy is accounted for by the increased secretion of endogenous opioids caused by the myorelaxation, antiphlogistic and antiedematous effect and maybe also the impact on presynaptic inhibition of nociceptive signals at the level of the medullary dorsal horns.

The treatment should be combined with aimed pharmacotherapy, manual treatment and relaxation therapy, at least in the initial stage.

3.2 ANTIPHLOGISTIC EFFECT

This effect has not been convincingly explained so far, but recent studies agree on the following principle:

The antiphlogistic effect is induced by increased phagocytosis of neutrophils and the increased production of hyperoxide. This is followed by the induction of hyperoxide dismutase bound to endothelium, which all probably leads to a higher concentration of hydrogen peroxide in the exposed area. Owing to the fact that hyperoxide inhibits the activity of catalase, the hydrogen peroxide is not degraded and thus is able to destroy leucotriens, some of the strongest activators of phagocytosis.

This mechanism also explains the initial controversial action of the magnetic field in sterile inflammations as well as in microbially induced inflammations. This effect also accounts for temporary impairment of rheumatic

conditions during the first two or three exposures, when the inflammatory symptoms are intensified by increasingly produced hyperoxide.

Simultaneous medication and physical therapy is necessary; the patient must be monitored during the therapy and in case of longer negative reaction, the therapy must be stopped.

3.3 TROPHIC EFFECT

The magnetic field accelerates healing of the skeleton and soft tissues. It is caused by better blood circulation in the exposed area and by the irritation of cytoplasmic membranes. This activates the metabolic chain, the key point of which is a change in the cAMP/cGMP ratio.

The acceleration of healing, especially of the skeleton, is described in detail in the literature (Chvojka, 1993, 2000).

3.4 MYORELAXATION AND SPASMOLYTIC EFFECT

Increased blood circulation in the area improves the washing away of acidic metabolites which cause painful irritation. In the muscles exposed to the magnetic field there also proceeds increased activity of LDH (lactate dehydrogenase) and efflux of the Ca^{2+} ion from muscle cells.

3.5 VASODILATATION EFFECT

This effect is caused by the efflux of Ca^{2+} ions, which causes relaxation of the tonus of the vascular musculature and precapillary sphincters. Probably the n. vagus is also directly influenced and the increased metabolic activity of cells in the exposed area results in the creation of EDRF and prostacyclins.

3.6 ANTIEDEMATOUS EFFECT

This effect results from the two above-described effects - the antiphlogistic effect of the magnet and acceleration of healing and improved blood circulation.



4. RECOMMENDED DOSAGE OF MAGNETOTHERAPY

Suitable dosages for the particular application can be estimated from the following relations. The resulting dose rises along with:

- higher value of magnetic induction (intensity) of the magnetic field B_{\max} [T],
- greater steepness of rising and falling edges of magnetic field pulses dB/dt [T/s],
- higher frequency of magnetic field pulses f [Hz] and
- longer time of exposure (in **hours**).

$$\text{dose} = B_{\max} * dB/dt * \text{time of exposure} * f$$

The optimum dose should range from 4 to 8.

The following procedure for selecting the optimum does of magnetotherapy is recommended:

- The applicators should be as close as possible to the patient's body surface. Direct contact with the body is not necessary, therapy may be applied through clothes or bandages.
- Magnetotherapy should be applied as soon as possible - it will better influence functional disorders, not structural changes.
- For sterile inflammations, it is suitable to use frequency up to 10 Hz.
- For microbially induced inflammations (sinusitis, osteomyelitis), it is suitable to use pulse frequency at about 25 Hz.
- In degenerative diseases of locomotive organs, the recommended pulse frequency is above 10 Hz.
- When treating tennis elbow and frozen shoulder, it is suitable to expose the C-spine at the same time.
- When treating subacute and acute vertebrogenous troubles, it is also recommended to expose the pain trigger points (TPs).
- Individual exposures must be long enough and repeated. The minimum exposure time is at least 10 minutes, the minimum number of exposures is 10 to 15.
- **The total daily exposure should not exceed 40 minutes.**
- The best results are achieved when the first 5 to 10 exposures are performed daily or twice a day.
- If magnetotherapy does not start to work within 20 procedures, it fails. An exception is the treatment of pseudo-arthroses, where the first visible signs of healing can be observed, using display methods, not sooner than after 30 procedures.
- In approximately 30% of rheumatics, there can be expected subjective impairment of the condition after the first 3 exposures.
- If possible, do not end magnetotherapy at once, but by gradual prolongation of intervals between individual exposures.

Special attention shall be paid to patients with hypotension and hypertension. During therapy, a significant drop in blood pressure may occur, including all the side effects. This reaction usually disappears within 30 minutes of the end of therapy and the adaptation occurs approximately after 5 exposures.

For contraindications, see the main **User's Manual** of the device, chapter **Contraindications**.



5. BIBLIOGRAPHY

- CALTA, J., MACHÁLEK, Z., VACEK, J. Základy fyzikální terapie pro praxi. Praha: Knihovna REFORa, 1994.
- CAPKO, J. Základy fyziatrické léčby. Praha: Grada, 1998.
- HUPKA, J., KOLESÁR, J., ŽALOUDEK, K.: Fyzikální terapie. Praha: Avicenum, 1988.
- CHVOJKA, J.: Magnetoterapie v klinické praxi. Městec Králové, 1993.
- CHVOJKA, J.: Magnetoterapie v teorii a praxi. Praha: Professional Publishing, 2000.
- IPSER, J., PŘEROVSKÝ, K. Fysiatrie, Praha: Avicenum, 1972.
- JERÁBEK, J.: Magnetoterapie. Nový Bydžov, Hradec Králové: 2EL, 1993.
- KŘIVOHLAVÝ, J. Bolest, její diagnostika a psychoterapie. Praha: Institut pro další vzdělávání lékařů a farmaceutů, 1992.
- MELZACK, R., WALL, P. D. Textbook of Pain. New York: Churchill Livingstone, 1984.
- NIEPEL, G.: Fyzikální terapie v praxi. Receptář. Brno: IDVPZ, 1998.
- PODĚBRADSKÝ, J., VAŘEKA, I. Fyzikální terapie I.. Praha: Grada-Avicenum, 1998.
- PODĚBRADSKÝ, J., VAŘEKA, I.: Fyzikální terapie II. Praha: Grada-Avicenum, 1998.
- VAŘEKA, I. Základy fyzikální terapie. Olomouc: vydavatelství UP Olomouc, 1995.
- C. A. L. Bassett and M. Schink-Ascani, "Long-term Pulsed Electromagnetic Field (PEMF) Results in Congenital Pseudarthrosis", *Calcified Tissue International*, 49, 1991, pp. 216-220.
- C. A. L. Bassett, R. J. Pawluk, and A. A. Pilla, "Acceleration of Fracture Repair by Electromagnetic Fields: A Surgically Non-invasive Method", *Annals of the New York Academy of Sciences*, 238, 1974, pp. 242-262
- C. A. L. Bassett, R. J. Pawluk, and A. A. Pilla, "Augmentation of Bone Repair by Inductively Coupled Electromagnetic Fields", *Science*, 184, 136, 1974, pp. 575-577
- C. A. L. Bassett, A. A. Pilla, and R. J. Pawluk, "A Nonoperative Salvage of Surgically-Resistant Pseudarthroses and Non-unions by Pulsing Electromagnetic Fields", *Clinical Orthopaedics and Related Research*, 124, 1977, pp. 128-143
- C. A. L. Bassett, M. G. Valdest and E. Hernandez, "Modification of Fracture Repair with Selected Pulsing Electromagnetic Fields", *The Journal of Bone and Joint Surgery*, Vol. 64-A, NO 6, 1982, pp. 888-895
- Bawin, S.M. and W.R. Adey "Sensitivity of Calcium Binding in Cerebral Tissue to Weak Environmental Electric Fields Oscillating at Low Frequency", *Proceedings of the Afafona/Acaderny of Sciences* 73(6), June, 1976, pp. 1999-2003.
- A. Binder, G. Parr, B. Hazleman, and S. Fitton-Jackson, "Pulsed Electromagnetic Field Therapy of Persistent Rotator Cuff Tendinitis: A Double-blind Controlled Assessment", *The Lancet*, 1, 8379, 1984, pp. 695-698.
- Blackman, C. F., S.G. Benane, D.E. House, J.R. Rabinowitz, and W.T. Joines, "ELF Electromagnetic Fields Cause Enhanced Efflux of Neutral Sugars from Brain Tissue In Vitro", Technical Report, Abstract, Ninth Annual Meeting of the Bioelectromagnetics Society, Portland, OR, June 1987, pp.21-25.
- Brown, C. S., Lingm F. W., Wan, J. Z. and A. A. Pilla, "Efficacy of static magnetic field therapy in chronic pelvic pain: A double-blind pilot study", *Am J Obstet Gynecol*; 187, 2002, pp. 1581-1587.
- M. A. Darendeliler, A. Darendeliler, and P. M. Sinclair, "Effects of Static Magnetic and Pulsed Electromagnetic Fields on Bone Healing", *International Journal of Adult Orthodontic and Orthognathic Surgery*, 12, 1, 1997, pp. 43-53.
- G. De Haas, M. A. Lazarovici, and D. M. Morrison, "The Effect of Low Frequency Magnetic Fields on the Healing of the Osteotomized Rabbit Radius", *Clinical Orthopaedics and Related Research*, 145, 1979, pp. 245-251.



- J. L. Fleming, M. A. Persinger, and S. A. Koren, "Magnetic Pulses Elevate Nociceptive Thresholds: Comparisons with Opiate Receptor Compounds in Normal and Seizure-Induced Brain-Damaged Rats", *Electro- and Magnetobiology*, 13, 1, 1994, pp. 67-75.
- P. A. Glazer, M. R. Heilmann, J. C. Lotz, and D. S. Bradford, "Use of Electromagnetic Fields in a Spinal Fusion: A Rabbit Model", *Spine*, 22, 1997, pp. 2351-2356.
- J. D. Heckman, A. J. Ingram, R. D. Loyd, J. V. Luck Jr., and P. W. Mayer, "Nonunion Treatment with Pulsed Electromagnetic Fields", *Clinical Orthopaedics and Related Research*, 161, 1981, pp. 58-66.
- Hinman, M. R., Ford, J., and H. Heyl, "Effects of static magnets on chronic knee pain and physical function: A double-blind study", *Alternative Therapies in Health and Medicine*, Vol. 8, No. 4, 2002, pp. 50-55.
- M. Ieran, S. Zaffuto, M. Bagnacani, M. Annovi, A. Moratti, and R. Cadossi, "Effect of Low Frequency Pulsing Electromagnetic Fields on Skin Ulcers of Venous Origin in Humans: A Double-blind Study", *Journal of Orthopaedic Research*, 8, 2, 1990, pp. 276-282.
- H. Ito, Y. Shirai and Y. Gembun, "A Case of Congenital Pseudarthrosis of the Tibia Treated with Pulsing Electromagnetic Fields, 17-Year Follow-up", *J Nippon Med Sch*; 67,3, 2000, pp. 198-201.
- J. I. Jacobson, R. Gorman, W. S. Yamanashi, B. B. Saxena, and L. Clayton, "Low-amplitude, Extremely Low Frequency Magnetic Fields for the Treatment of Osteoarthritic Knees: A Double-blind Clinical Study", *Alternative Therapies*, 7, 5, 2001, pp. 54-69.
- Jeřábek J., "Magnetoterapie", *Rehabilitace a fyzikální lékařství*; 3 (2), 1996, pp. 55-62.
- W. A. Jorgensen, B. M. Frome, and C. Wallach, "Electrochemical Therapy of Pelvic Pain: Effects of Pulsed Electromagnetic Fields (PEMF) on Tissue Trauma", *The European Journal of Surgery*, 574 (Supplement), 1994, pp. 83-86.
- M. Kanje, A. Rusovan, B. Sisken, and G. Lundborg, "Pretreatment of Rats with Pulsed Electromagnetic Fields Enhances Regeneration of the Sciatic Nerve", *Bioelectromagnetics*, 14, 1993, pp. 353-359.
- K. Konrad, K. Sevcic, K. Földes, E. Piroška, and E. Molnár, "Therapy with Pulsed Electromagnetic Fields in Aseptic Loosening of Total Hip Prostheses: A Prospective Study", *Clinical Rheumatology*, 15, 4, 1996, pp. 325-328.
- Kuba, J., Procházka, M., "Klinické testování přístroje k terapii magnetickým pulzním polem s kritérii dvojité slepě uspořádané studie", *Rehabilitace a fyzikální lékařství*, 7 (1), 2000, pp. 24-27.
- R. A. Marks, "Spine Fusion for Discogenic Low Back Pain: Outcomes in Patients Treated with or without Pulsed Electromagnetic Field Stimulation", *Advances in Therapy*, 17, 2, 2000, pp. 57-67.
- H. Matsumoto, M. Ochi, Y. Abiko, Y. Hirose, T. Kaku, K. Sakaguchi, "Pulsed Electromagnetic Fields Promote Bone Formation around Dental Implants Inserted into the Femur of Rabbits", *Clinical Oral Implants Research*, 11, 2000, pp. 354-360
- V. Mooney, "A Randomized Double-blind Prospective Study of the Efficacy of Pulsed Electromagnetic Fields for Interbody Lumbar Fusions", *Spine*, 15, 7, 1990, pp. 708-712.
- F. Papi, S. Ghione, C. Rosa, C. Del Seppia, and P. Luschi, "Exposure to Oscillating Magnetic Fields Influences Sensitivity to Electrical Stimuli. II. Experiments on Humans", *Bioelectromagnetics*, 16, 1995, pp. 295-300.
- Pipitone, N. and D. L. Scott. "Magnetic Pulse Treatment for Knee Osteoarthritis: A Randomised, Double-Blind, Placebo-Controlled Study", *Current Medical Research and Opinion*, Vol. 17, No. 3, 2001, pp. 190-196.
- T. L. Richards, M. S. Lappin, J. Acosta-Urquidi, G. H. Kraft, A. C. Heide, F. W. Lawrie, T. E. Merrill, G. B. Melton, and C. A. Cunningham, "Double-blind Study of Pulsing Magnetic Field Effects on Multiple Sclerosis", *The Journal of Alternative and Complementary Medicine*, 3, 1, 1997, pp. 21-29.
- N. J. Roland, J. B. Hughes, M. B. Daley, J. A. Cook, A. S. Jones, and M. S. McCormick, "Electromagnetic Stimulation as a Treatment of Tinnitus: A Pilot Study", *Clinical Otolaryngology and Applied Sciences*, 18, 1993, pp. 278-281.
- Sadlonova, J., Korpas, J., Salat, D., Miko, L., Kudlicka, J., "The effect of the pulsatile electromagnetic field in children suffering from bronchial asthma", *Acta Physiol Hung.*, 90(4), 2003, pp. 327-34.



- Sadlonova J, Korpas J, Vrabec M, Salat D, Buchancova J, Kudlicka J., ""The effect of the pulsatile electromagnetic field in patients suffering from chronic obstructive pulmonary disease and bronchial asthma"", Bratisl Lek Listy; 103 (7-8), 2002, pp. 260-265."
- E. R. Sanseverino, A. Vannini, and P. Castellacci, "Therapeutic Effects of Pulsed Magnetic Fields on Joint Diseases", *Panminerva Medica*, 34, 4, 1992, pp. 187-196.
- F. Sartucci, L. Bonfiglio, C. Del Seppia, P. Luschi, S. Ghione, L. Murri, and F. Papi, "Changes in Pain Perception and Pain Induced by Exposure to Oscillating Magnetic Fields", *Brain Research*, 769, 1997, pp. 362-366.
- B. F. Siskin, M. Kanje, G. Lundborg, E. Herbst, and W. Kurtz, "Stimulation of Rat Sciatic Nerve Regeneration with Pulsed Electromagnetic Fields", *Brain Research*, 485, 1989, pp. 309-316.
- M. J. Stiller, G. H. Pak, J. L. Shupack, S. Thaler, C. Kenny, and L. Jondreau, "A Portable Pulsed Electromagnetic Field (PEMF) Device to Enhance Healing of Recalcitrant Venous Ulcers: A Double-blind, Placebo-controlled Clinical Trial," *British Journal of Dermatology*, 127, 1992, pp. 147-154.
- Sweeney, K. B., Merrick, M. A., Ingersoll, Ch., D., and J. A. Swez, "Therapeutic Magnets Do Not Affect Tissue Temperatures", *J. Athl. Train.*, 36 (1), 2001 March, pp. 27-31.
- F. Tabrah, M. Hoffmeier, F. Gilbert Jr., S. Batkin, and C. A. L. Bassett, "Bone Density Changes in Osteoporosis prone Women Exposed to Pulsed Electromagnetic Fields (PEMFs)", *Journal of Bone and Mineral Research*, 5, 5, 1990, pp. 437-442.
- G. C. Traina, L. Romanini, F. Benazzo, R. Cadossi, V. Canè, A. Chiabrera, M. Marcer, N. Marchetti, and F. S. Snatori, "Use of Electric and Magnetic Stimulation in Orthopaedics and Traumatology: Consensus Conference", *Italian Journal of Orthopaedics and Traumatology*, 24, 1, 1998, pp. 1-31.
- D. H. Wilson and P. Jagadeesh, "Experimental Regeneration in Peripheral Nerves and the Spinal Cord in Laboratory Animals Exposed to a Pulsed Electromagnetic Field", *Paraplegia*, 14, 1976, pp. 12-20.



6. SETTING AND CONTROL OF MAGNETOTHERAPY – TECHNICAL PARAMETERS

6.1 MAGNETIC FIELD INTENSITY

The magnetic field intensity can be set from 1 mT/10 (i.e. 1 Gauss) and its maximum value depends on the applicator type and the type of selected therapy application. For the maximum values in dependence on the applicator type, see the chapter **Applicators**.

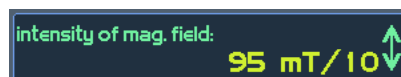

The step in setting is 1 mT/10 (i.e. 1 Gauss).

The set intensity value represents the maximum intensity in space and time.

The accuracy of the set intensity value is $\pm 30\%$.

6.2 THERAPY DURATION

Can be set within a range from 1 second to 100 minutes, i.e. from 00:01 to 99:59 [m:s].



The step in setting is 1 second.

The accuracy of the set time is 2%.

6.3 PHYSIOLOGICAL EFFECTS

The effects are defined for preset diagnoses and the user can define them for customer diagnoses and programs, created and saved by the user.

Legend:

- **A** – analgesic
- **E** – antiedematous
- **F** – antiphlogistic
- **S** – trophic, acceleration of healing
- **R** – myorelaxation and spasmolytic (vasodilatation, antiedematous,...)

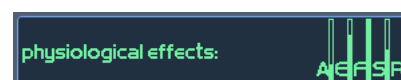

6.4 SELECTION OF THERAPY

Press the **[therapy]** button to open the dialog box (see picture) for selection of the best magnetic field therapy. The following therapy options are available:

- magnetic pulses
- series of magnetic pulses
- continuous magnetic field.

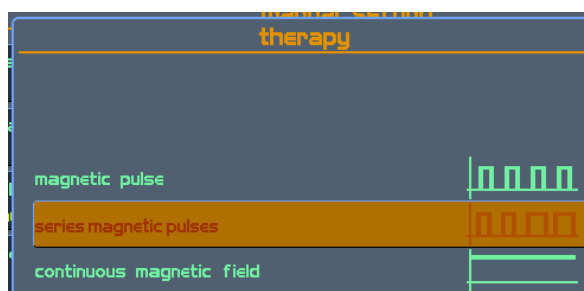

The properties of individual therapies are described in the paragraphs below.

6.4.1 MAGNETIC PULSES

Standard waveforms of magnetic pulses; it is possible to select between constant and randomly swept frequency of the selected pulses. For selection of the pulse shape, use the **[pulse shape]** button. The following options are available:

- rectangular pulses,
- rectangular protracted pulses,
- exponential pulses,
- sinusoidal pulses and
- triangular pulses.

The following modulations can be applied to the magnetic pulses:

- burst,
- sine surges,
- trapezoid surges and
- symmetric surges.

Pulse, Pause, Frequency – Setting

On pressing the displayed window, the dialog box opens, in which it is possible to set the following pulse parameters: pulse length, pause between pulses and pulse frequency.



Owing to the fact that these values are mutually interconnected through mathematical definitions, any change of a value implies automatic changes of the other values.

When setting, it is necessary to realize that the pause length must always be longer than the pulse length (construction limits).

The limits for setting differ for various pulse shapes - for details, see the chapter **Pulse Shape**.

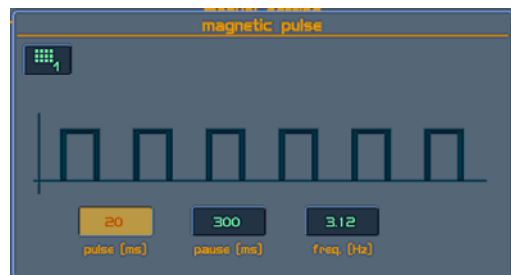

6.4.2 SERIES OF MAGNETIC PULSES

These very interesting magnetic pulse waveforms were first used in the BTL-09 device, but were limited to rectangular pulses only. The BTL-4000, BTL-4000 Topline and BTL-5000 devices offer these pulses for all pulse shapes:

- rectangular pulses,
- rectangular protracted pulses,
- exponential pulses,
- sinusoidal pulses and
- triangular pulses.

In principle, it is a mix of pulses of various length and frequency in one series to be repeated. It is advantageous to combine, for example, long pulses of low frequency with very short pulses of high repeating frequency and thus cumulate the therapy effect.

It is also possible to select between **constant and randomly swept frequency** of the selected pulses.

The following modulations can be applied to the magnetic pulses:

- sine surges,
- trapezoid surges and
- symmetrical surges.

Pulse, Pause, Frequency, Repeating – Setting of Series

After pressing the displayed button, the dialog box opens, in which it is possible to set the following parameters of the series of pulses: pulse length, pause between pulses, pulse frequency, number in the series and length of the series.



For each period – part of the series – it is possible to set the standard pulse parameters:

- **pulse length**,
 - **length of pause** between pulses,
 - **pulse frequency** and
 - **number of pulses** with this setting to be generated.
- After the end of generation of this part, the program passes to another one.

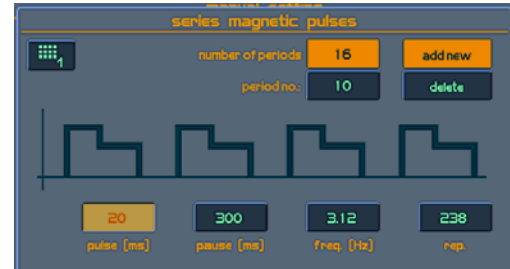

The limits for setting the pulse length, pause and frequency differ for various pulse shapes – for details, see the chapter **Pulse Shape**.

The **number of repetitions** of individual pulses can be set within a range **from 1 to 255**. The step of setting is **1**.

The window displays the total number of parts in the series and the **[add new]** button, the field for displaying the number of the part being edited (10 in this case) and the button for deleting the selected part of the series.

In total, it is possible to set **13 parts** in one series.

Owing to the fact that the values of the pulse length, pause and frequency are mutually interconnected through mathematical definitions, any change of a value implies automatic changes of the other values.

When setting, it is necessary to realize that the pause length must always be longer than the pulse length (construction limits).

6.4.3 CONTINUOUS MAGNETIC FIELD

The BTL 4000 / 4000 Topline / 5000 devices enable a stationary magnetic field to be generated, which is similar to the fields around permanent magnets. This field is recommended for applications where the effects of the pulse electromagnetic field could cause serious problems and is therefore contraindicated - e.g. in case of increased bleeding conditions, acute states, post-operative conditions, etc. The effect of this field is also increased by the presence of permanent magnets in our “disc” type applicators. The application of this type of field is recommended in the first stages of magnetotherapy; after approximately the first or second week it is recommended to change over to the pulse field.



Continuous magnetic field can be modulated by slow magnetic field surges with a length of several seconds or more.

- sine surges,
- trapezoid surges and
- symmetric surges.

6.5 PULSE SHAPE

This button serves for selecting the required shape of magnetic pulses. The following options are available:



- rectangular pulses
- rectangular protracted pulses
- exponential pulses
- sinusoidal pulses
- triangular pulses.

6.5.1 RECTANGULAR PULSES

These pulses are a sort of “gold standard” in pulse magnetotherapy. In addition to the options that are available in the BTL-09 device, the BTL 4000 / 4000-Topline / 5000 devices also provide modulation of the contour of the following pulses:

- trapezoid surges,
- sine surges,
- symmetric surges and
- bursts.



Rectangular pulses can be set within the following range:

- pulse length t_p from 3 ms to 255 ms
 - step in setting:
 - 1 ms (from 3 ms to 30 ms)
 - 2 ms (from 30 ms to 50 ms)
 - 5 ms (from 50 ms to 100 ms)
 - 10 ms (from 100 ms to 255 ms)
 - a specific value (e.g. 58 ms) can be set using the keyboard
- pause between pulses t_i from 3 ms to 65,000 ms
 - the set pause is always longer than the set pulse length: $t_i > t_p$
 - step in setting:
 - 1 ms (from 3 ms to 30 ms)
 - 2 ms (from 30 ms to 50 ms)
 - 5 ms (from 50 ms to 100 ms)
 - 10 ms (from 100 ms to 200 ms)
 - 20 ms (from 200 ms to 500 ms)
 - 50 ms (from 500 ms to 1000 ms)
 - 100 ms (from 1,000 ms to 65,000 ms)
 - a specific value (e.g. 583 ms) can be set using the keyboard
- the frequency of pulses can be set within a range from 0.015 Hz to 166 Hz
 - step in setting:
 - 0.01 Hz (from 0.01 Hz to 0.30 Hz)
 - 0.02 Hz (from 0.30 Hz to 0.50 Hz)
 - 0.05 Hz (from 0.50 Hz to 1.00 Hz)
 - 0.10 Hz (from 1.00 Hz to 5.00 Hz)
 - 0.50 Hz (from 5.00 Hz to 10.0 Hz)
 - 1.00 Hz (from 10.0 Hz to 30.0 Hz)
 - 2.00 Hz (from 30.0 Hz to 50.0 Hz)
 - 5.00 Hz (from 50.0 Hz to 70.0 Hz)
 - 10.0 Hz (from 70.0 Hz to 100 Hz)
 - 15.0 Hz (from 100.0 Hz to 166 Hz)
 - the specific value is calculated by the device from the values of pulse length and pause length

$$f = 1 / (t_i + t_p)$$

6.5.2 RECTANGULAR PROTRACTED PULSES

On the basis of our experience with pulse magnetic fields, we designed this new type of current which utilizes the advantageous properties of rectangular pulses – great steepness of the rising and falling edges. At the same time, it significantly reduces the power consumption of the generated magnetic field pulses and extends the duration of the pulse.



So it is possible to generate pulses of higher intensities than in standard rectangular pulses with the same power consumption (the same heating of the applicators).

Similarly as in standard rectangular pulses, all modulations of pulse contours are available here, including random frequency sweep, preset programs and recommended diagnoses.

Protracted rectangular pulses can be set within the following range:

- pulse length t_p from 6 ms to 510 ms
 - step in setting:
 - 1 ms (from 6 ms to 30 ms)
 - 2 ms (from 30 ms to 50 ms)
 - 5 ms (from 50 ms to 100 ms)
 - 10 ms (from 100 ms to 510 ms)
 - a specific value (e.g. 58 ms) can be set using the keyboard

- pause between pulses t_i from 6 ms to 65,000 ms
 - the set pause is always longer than the set pulse length: $t_i > t_p$
 - step in setting:
 - 1 ms (from 6 ms to 30 ms)
 - 2 ms (from 30 ms to 50 ms)
 - 5 ms (from 50 ms to 100 ms)
 - 10 ms (from 100 ms to 200 ms)
 - 20 ms (from 200 ms to 500 ms)
 - 50 ms (from 500 ms to 1000 ms)
 - 100 ms (from 1,000 ms to 65,000 ms)
 - a specific value (e.g. 583 ms) can be set using the keyboard

- the frequency of pulses can be set within a range from 0.015 Hz to 83.3 Hz
 - step in setting:
 - 0.01 Hz (from 0.01 Hz to 0.30 Hz)
 - 0.02 Hz (from 0.30 Hz to 0.50 Hz)
 - 0.05 Hz (from 0.50 Hz to 1.00 Hz)
 - 0.10 Hz (from 1.00 Hz to 5.00 Hz)
 - 0.50 Hz (from 5.00 Hz to 10.0 Hz)
 - 1.00 Hz (from 10.0 Hz to 30.0 Hz)
 - 2.00 Hz (from 30.0 Hz to 50.0 Hz)
 - 5.00 Hz (from 50.0 Hz to 70.0 Hz)
 - 10.0 Hz (from 70.0 Hz to 83.3 Hz)
 - the specific value is calculated by the device from the values of pulse length and pause length
 $f = 1 / (t_i + t_p)$

6.5.3 EXPONENTIAL PULSES

Similarly as in electrotherapy, these pulses are very interesting thanks to their mild gradual rising and, at the same time, high pulse intensities, which they achieve at very low power consumption. That is why they are suitable especially in applications where the high energy of the electromagnetic field is undesirable but high pulse intensity is required. These pulses apply especially in the stimulation of neural paths by induced currents.



In exponential pulses, it is also possible to apply surge modulations similarly as in rectangular pulses.

Exponential pulses can be set within the following range:

- pulse length t_p from 6 ms to 510 ms
 - step in setting: the same as for **rectangular protracted pulses**
 - a specific value (e.g. 58 ms) can be set using the keyboard
- pause between pulses t_i from 6 ms to 65,000 ms
 - the set pause is always longer than the set pulse length: $t_i > t_p$
 - step in setting: the same as for **rectangular protracted pulses**
 - specific value (e.g. 583 ms) can be set using the keyboard
- the frequency of pulses can be set within a range from 0.015 Hz to 83.3 Hz
 - step in setting: the same as for **rectangular protracted pulses**
 - the specific value is calculated by the device from the values of pulse length and pause length
 $f = 1 / (t_i + t_p)$

6.5.4 SINUSOIDAL PULSES

Classic sinusoidal pulses derived from the mains voltage. They are used particularly in well-tried standard therapies. The setting options are the same as for rectangular pulses, including modulation.



Setting options:

- pulse length t_p from 6 ms to 510 ms
 - step in setting: the same as for **rectangular protracted pulses**
 - a specific value (e.g. 58 ms) can be set using the keyboard
- pause between pulses t_i from 6 ms to 65,000 ms
 - the set pause is always longer than the set pulse length: $t_i > t_p$
 - step in setting: the same as for **rectangular protracted pulses**
 - a specific value (e.g. 583 ms) can be set using the keyboard
- the frequency of pulses can be set within a range from 0.015 Hz to 83.3 Hz
 - step in setting: the same as for **rectangular protracted pulses**
 - the specific value is calculated by the device from the values of pulse length and pause length
 $f = 1 / (t_i + t_p)$

6.5.5 TRIANGULAR PULSES

Symmetric triangular pulses with the same rising time and falling time. In some countries, their use is very widespread. The setting options are the same as for rectangular pulses, including modulation.



Setting options:

- pulse length t_p from 6 ms to 510 ms
 - step in setting: the same as for **rectangular protracted pulses**
 - a specific value (e.g. 58 ms) can be set using the keyboard
- pause between pulses t_i from 6 ms to 65,000 ms
 - the set pause is always longer than the set pulse length: $t_i > t_p$
 - step in setting: the same as for **rectangular protracted pulses**
 - a specific value (e.g. 583 ms) can be set using the keyboard
- the frequency of pulses can be set within a range from 0.015 Hz to 83.3 Hz
 - step in setting: the same as for **rectangular protracted pulses**
 - the specific value is calculated by the device from the values of pulse length and pause length
 $f = 1 / (t_i + t_p)$

6.6 MODULATION

For detailed modulation settings, press the **[mag. param.]** window.



6.6.1 RANDOM FREQUENCY

Can be selected for all pulse types. The option switches on the sweep of the set pause length within a range from 0 to + 30%.

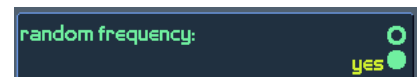

In the previous BTL-09 device, this function was called “wave swing”. For the BTL-4000 / 4000 Topline / 5000 devices, we decided to unify the name with other types of physiotherapy, such as electrotherapy, etc.

6.6.2 BURST

This option cannot be used in the series of magnetic pulses and the continuous field.



It is possible to set the **number of pulses** in one burst within a range from 3 to 10. The length of such a defined burst in **[ms]** is displayed in the **[burst]** window.

The length of the pause between individual bursts can be set from 1 to 255 s.

The step in setting is:

- 1 s (from 1 s to 30 s)
- 2 s (from 30 s to 50 s)
- 5 s (from 50 s to 100 s)
- 10 s (from 100 s to 255 s)
- a specific value (e.g. 236 s) can be set using the keyboard.



Besides these options, it is possible to use some predefined settings – see picture, the value is displayed as the **number of pulses in burst / length of pause between bursts**.

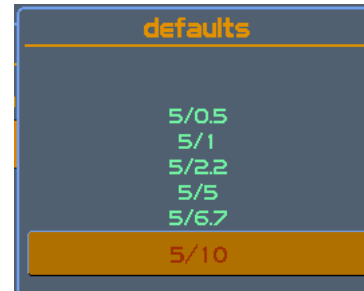

6.6.3 SINE SURGES

The surge length and the pause length can be set separately, both within a range from 1 s to 255 s.

The step in setting of both values is:

- 1 s (from 1 s to 30 s)
- 2 s (from 30 s to 50 s)
- 5 s (from 50 s to 100 s)
- 10 s (from 100 s to 255 s)
- a specific value (e.g. 236 s) can be set using the keyboard.

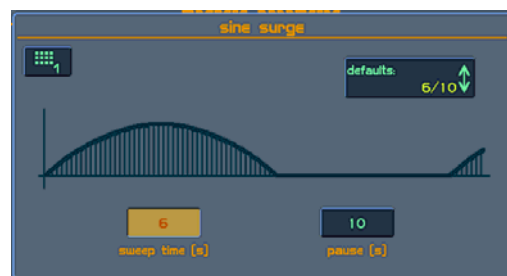
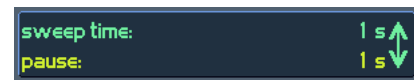

It is again possible to use predefined surges for setting.

6.6.4 TRAPEZOID SURGES

It is possible to set:

- surge rise from 1 s to 255 s
- surge duration from 1 s to 255 s
- fall of intensity from 1 s to 255 s and
- pause from 1 s to 255 s.

The step in setting of both values is:

- 1 s (from 1 s to 30 s)
- 2 s (from 30 s to 50 s)
- 5 s (from 50 s to 100 s)
- 10 s (from 100 s to 255 s)
- a specific value (e.g. 236 s) can be set using the keyboard.

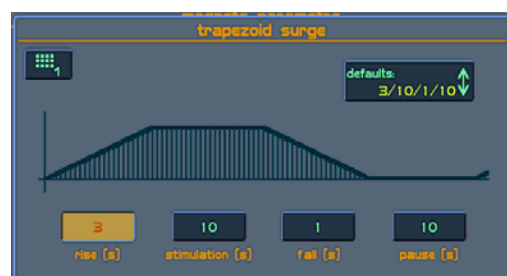

It is again possible to use predefined surges for setting.

6.6.5 SYMMETRIC SURGES

Another way of setting trapezoid surges, very widespread in some EU countries.

It is possible to set the "**sweep time**", the time of detuning and stabilization of the surge, within a range from 1 s to 255 s.

The step in setting is:

- 1 s (from 1 s to 30 s)
- 2 s (from 30 s to 50 s)
- 5 s (from 50 s to 100 s)
- 10 s (from 100 s to 255 s)
- a specific value (e.g. 236 s) can be set using the keyboard.

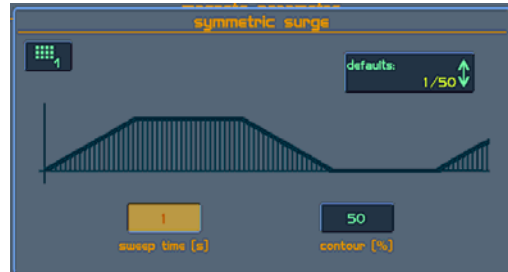

The "**contour**" parameter is the ratio between the change and the stable part of the surge. It can be set within a range from 1% to 100% change. The step in setting is 1%; the influence of the setting is best seen on the animated icon on the device.

It is again possible to use predefined surges for setting.

6.7 TEST OF CONNECTED APPLICATOR

To verify the function of the connected applicator, press the [**Induction of Magnet Accessories**] button.

For correct evaluation of the test, it is necessary to perform the test on a non-conducting surface - wooden or plastic.

In addition, it is important that the **double disk** or **multidisk** applicators are not on top of each other during the measuring, but beside each other.

The test measures the temperature and magnetic inductivity of the connected applicator. After the measuring, the measured values are compared with the standard values and on the basis of this comparison, the device evaluates whether the applicator works properly.

If the resulting test value is "**ok**", the applicator works properly.

If the test result is indicated as "**low value**" or "**high value**" (see picture), the applicator probably works improperly and it is necessary to contact the service.

Note:

Inductivity is a physical quantity which expresses the dimension of the magnetic induction flux through the coil.

Inductivity is one of the basic characteristics of a coil - it expresses the ability of the coil to change electric power to magnetic field energy.



7. APPLICATORS

The parameters of the magnetic applicators have been optimized with respect to the recommended therapeutic applications. Using **FMF** technology, the magnetic field is focused on the treated area, which allows, while preserving the same output intensity, the power consumption of the magnetotherapy device to be reduced, as well as the spurious magnetic field on the non-patient side of the applicators, which may potentially hit the operator.

The below described types of applicators can be connected to the BTL-4000 / 4000 Topline / 5000 device.

7.1 “DISC” APPLICATOR

The Disc applicator is made of plastic. The part which comes into contact with the patient is coated with fine durable leatherette.

The applicator is designed using **FMF technology** - the patient side emits a focused magnetic field, while on the other side the magnetic field is screened so that its impact on the surroundings is as low as possible.



Patient / application side of the applicator



Side turned away from the patient (operator side)

The side is marked with a pictograph of a “patient in the magnetic field”. The intensities on this side of the applicator are much higher than those on the operator side. During operation of the device the operator should not touch this side of the applicator.

Side marked with the BTL logo. It is also equipped with a blue indicator lamp which indicates operation of the applicator (continuous light, fast blinking) and its readiness for operation (slow blinking)

The magnetic applicator also contains a permanent magnet to increase the effect of soothing of the tissue in traumatic and bleeding conditions.

7.1.1 TECHNICAL PARAMETERS

Identification - Type	BTL-239-1
Name:	Disc
Dimensions:	130 x 130 x 30 mm
Weight:	1.05 kg
Intensity of the Permanent Magnet Field:	23 mT (230 Gauss)
Max. Intensity of Pulse Magnetic Field:	102 mT (1020 Gauss)
Max. Intensity of Magnetic Field in Total:	125 mT (1250 Gauss)

Resistance of the Applicator:	4.2 Ω
-------------------------------	--------------

7.1.2 SHAPE OF THE MAGNETIC FIELD OF THE APPLICATOR

The picture shows the shape of the applicator's magnetic field on the patient side. The unit of the intensity values is **mT/10**, i.e. Gauss, and the values are valid for the maximum current flowing through the applicator. The sum of intensity of the permanent magnet field and intensity of the pulse magnetic field is stated. The value 1250 mT/10 is in the centre, on the surface of the applicator.

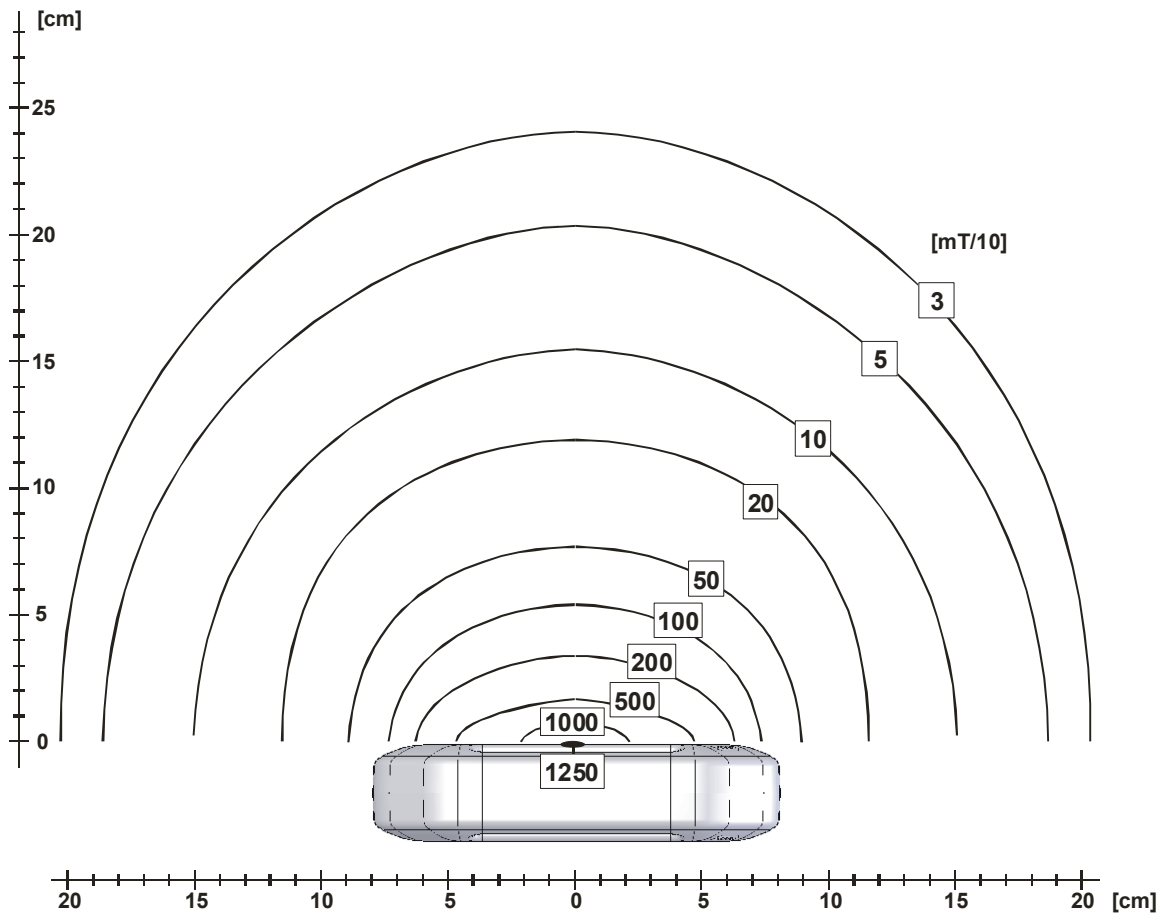

7.2 “DOUBLE DISC” APPLICATOR

The double disc applicator consists of the series interconnection of two disc applicators. The applicators are mutually orientated in such a way that a linearized magnetic field arises between them.

Similarly as the disc, the “double disc” applicator is made of plastic. The part which comes into contact with the patient is coated with fine durable leatherette.

The applicator is designed using **FMF technology** - the patient side emits a focused magnetic field, while on the other side the magnetic field is screened so that its impact on the surroundings is as low as possible.



Patient / application side of the applicator

The side is marked with a pictograph of a “patient in the magnetic field”. The intensities on this side of the applicator are much higher than those on the operator side. During operation of the device, the operator should not touch this side of the applicator.



Side turned away from the patient (operator side)

Side marked with the BTL logo. It is also equipped with a blue indicator lamp which indicates operation of the applicator (continuous light, fast blinking) and its readiness for operation (slow blinking)

The magnetic applicator also contains a permanent magnet to increase the effect of soothing of the tissue in traumatic and bleeding conditions.

7.2.1 TECHNICAL PARAMETERS

Identification - Type:	BTL-239-4
Name:	double disc
Dimensions:	2x 130 x 130 x 30 mm
Weight:	2.15 kg
Intensity of the Permanent Magnet Field:	23 mT (230 Gauss)
Max. Intensity of Pulse Magnetic Field:	72 mT (720 Gauss)
Max. Intensity of Magnetic Field in Total:	95 mT (950 Gauss)
Resistance of the Applicator:	8.4 Ω

7.2.2 SHAPE OF THE MAGNETIC FIELD OF THE APPLICATOR

The picture shows the shape of the applicator's magnetic field between the patient sides. The unit of the intensity values is **mT/10**, i.e. Gauss, and the values are valid for the maximum current flowing through the applicator. The sum of intensity of the permanent magnet field and intensity of the pulse magnetic field is stated. The highest value 950 mT/10 is in the centre, on the surface of the applicator.

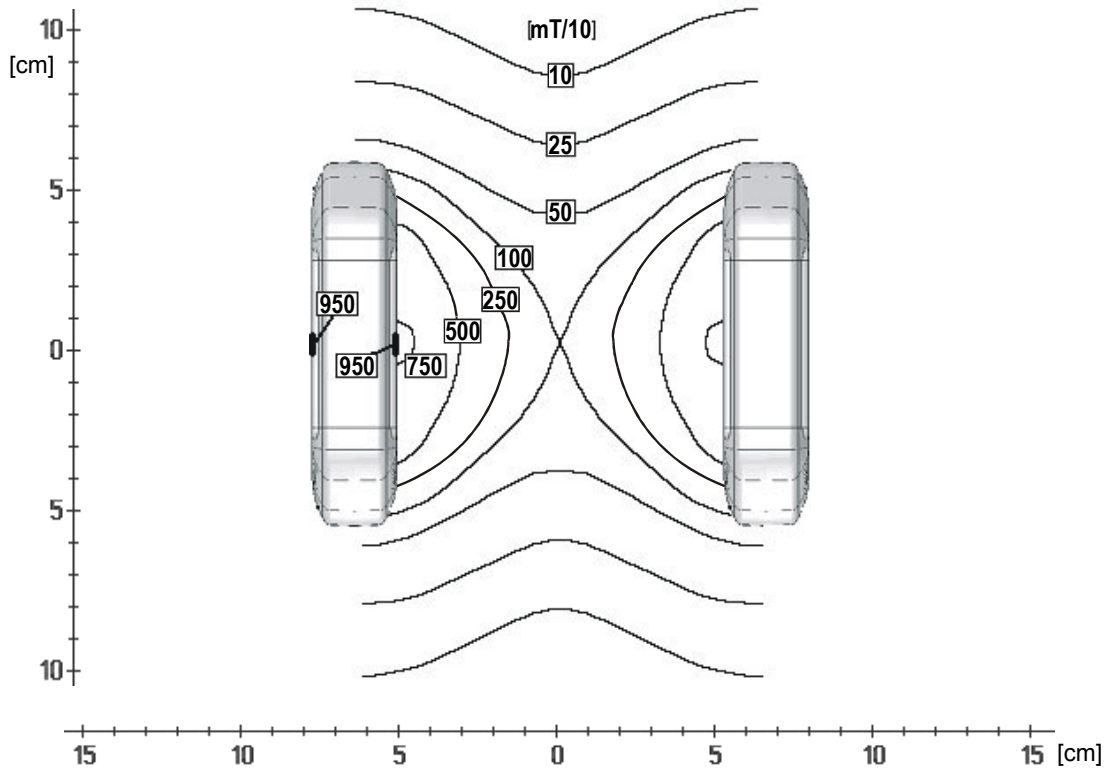

7.3 “MULTI DISC” APPLICATOR

The multi disc applicator consists of the series-parallel interconnection of four disc applicators. The applicators are mutually orientated in such a way that a linearized magnetic field arises between them.

The multi disc applicator was designed as a portable substitute for the solenoid 60 applicator. It can be easily used for applications which require the use of two double discs (application on the extremities). See recommended diagnoses for details.

Similarly as the disc, the multi disc applicator is made of plastic - harmless polypropylene. The part which comes into contact with the patient is coated with fine durable leatherette.

The applicator is designed using **FMF technology** - the patient side emits a focused magnetic field, while on the other side the magnetic field is screened so that its impact on the surroundings is as low as possible.



Patient / application side of the applicator

The side is marked with a pictograph of a “patient in the magnetic field”. The intensities on this side of the applicator are much higher than those on the operator side. During operation of the device, the operator should not touch this side of the applicator.



Side turned away from the patient (operator side)

Side marked with the BTL logo. It is also equipped with a blue indicator lamp which indicates operation of the applicator (continuous light, fast blinking) and its readiness for operation (slow blinking)

The magnetic applicator also contains a permanent magnet to increase the effect of soothing of the tissue in traumatic and bleeding conditions.

7.3.1 TECHNICAL PARAMETERS

Identification - Type:	BTL-239-5
Name:	multi disc
Dimensions:	4x 130 x 130 x 30 mm
Weight:	4.30 kg
Intensity of the Permanent Magnet Field:	23 mT (230 Gauss)
Max. Intensity of Pulse Magnetic Field:	52 mT (520 Gauss)
Max. Intensity of Magnetic Field in Total:	75 mT (750 Gauss)
Resistance of the Applicator:	4.2 Ω

7.3.2 SHAPE OF THE MAGNETIC FIELD OF THE APPLICATOR

The function of the multi disc applicator is similar to that of the double disc applicator where four disc applicators are on simultaneously during the therapy.

The intensity values are listed in the chapter **Technical Parameters** (the unit is **mT/10**, i.e. Gauss, and the values are valid for the maximum current flowing through the applicator). Then there is stated the sum of intensity of the permanent magnet field and intensity of the pulse magnetic field. The value 750 mT/10 is in the centre, on the surface of the applicator. The shape of the magnetic field of one pair of discs of the multi disc is the same as for the double disc.



7.4 “SOLENOID 30” APPLICATOR

The basis of the construction of this tube-shaped applicator is a carry tube made of polypropylene (PP), which was chosen because of its favourable mechanical parameters and low weight. A single-layer linear coil is wound onto the tube; the external magnetic field is screened off using **FMF technology**. The design of the applicator was adapted to the requirement to create a linear magnetic field in as large as possible part of the applicator.

7.4.1 TECHNICAL PARAMETERS

Identification - Type:	BTL-239-2
Name:	solenoid 30
Dimensions:	340 x 340 x 300 mm
Inner Diameter:	295 mm
Weight:	5.75 kg
Max. Intensity of Pulse Magnetic Field:	9.3 mT (93 Gauss)
Resistance of the Applicator:	3.5 Ω

7.4.2 SHAPE OF THE MAGNETIC FIELD OF THE APPLICATOR

The picture shows the shape of the applicator’s magnetic field. The unit of the intensity values is **mT/10**, i.e. Gauss, and the values are valid for the maximum current flowing through the applicator.

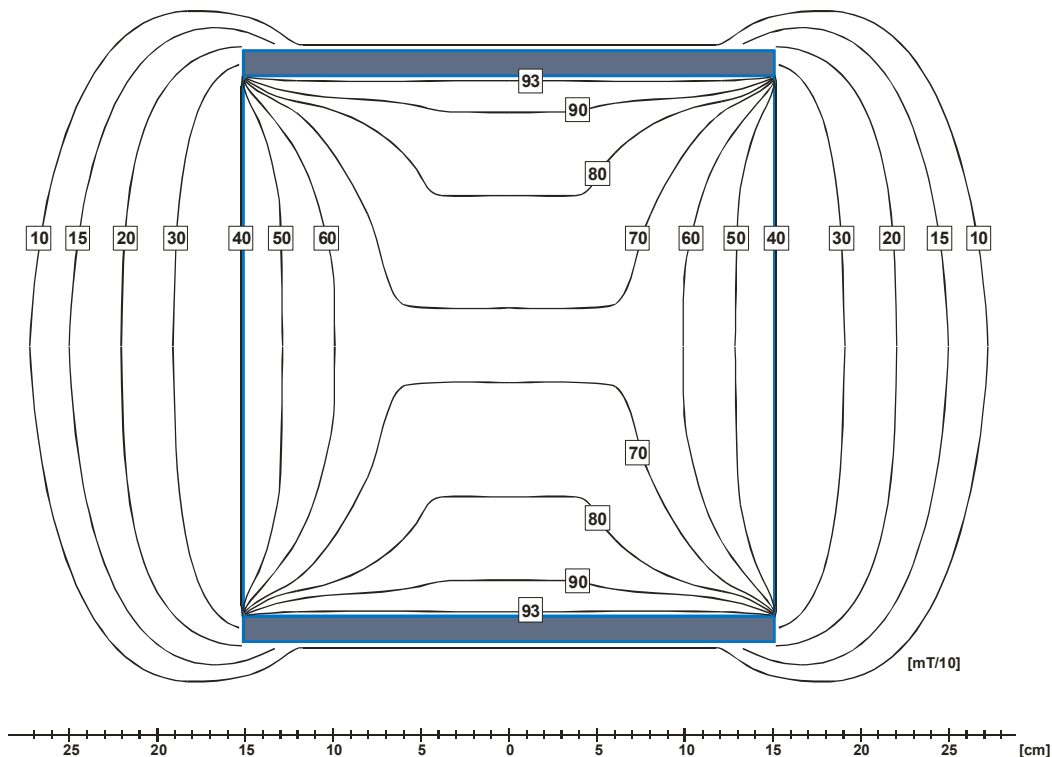

7.5 “SOLENOID 60” APPLICATOR

The basis of the construction of this tube-shaped applicator is a carry tube made of polypropylene (PP), which was chosen because of its favourable mechanical parameters and low weight. A single-layer linear coil is wound onto the tube; the external magnetic field is screened off using **FMF technology**. The design of the applicator was adapted to the requirement to create a linear magnetic field in as large as possible part of the applicator.

7.5.1 TECHNICAL PARAMETERS

Identification - Type:	BTL-239-3
Name:	solenoid 60
Dimensions:	620 x 540 x 300 mm
Inner Width:	580 mm
Inner Height:	480 mm
Weight:	10.0 kg
Max. Intensity of Pulse Magnetic Field:	8.5 mT (85 Gauss)
Resistance of the Applicator:	6.2 Ω

7.5.2 SHAPE OF THE MAGNETIC FIELD OF THE APPLICATOR

The picture shows the shape of the applicator’s magnetic field. The unit of the intensity values is **mT/10**, i.e. Gauss, and the values are valid for the maximum current flowing through the applicator.

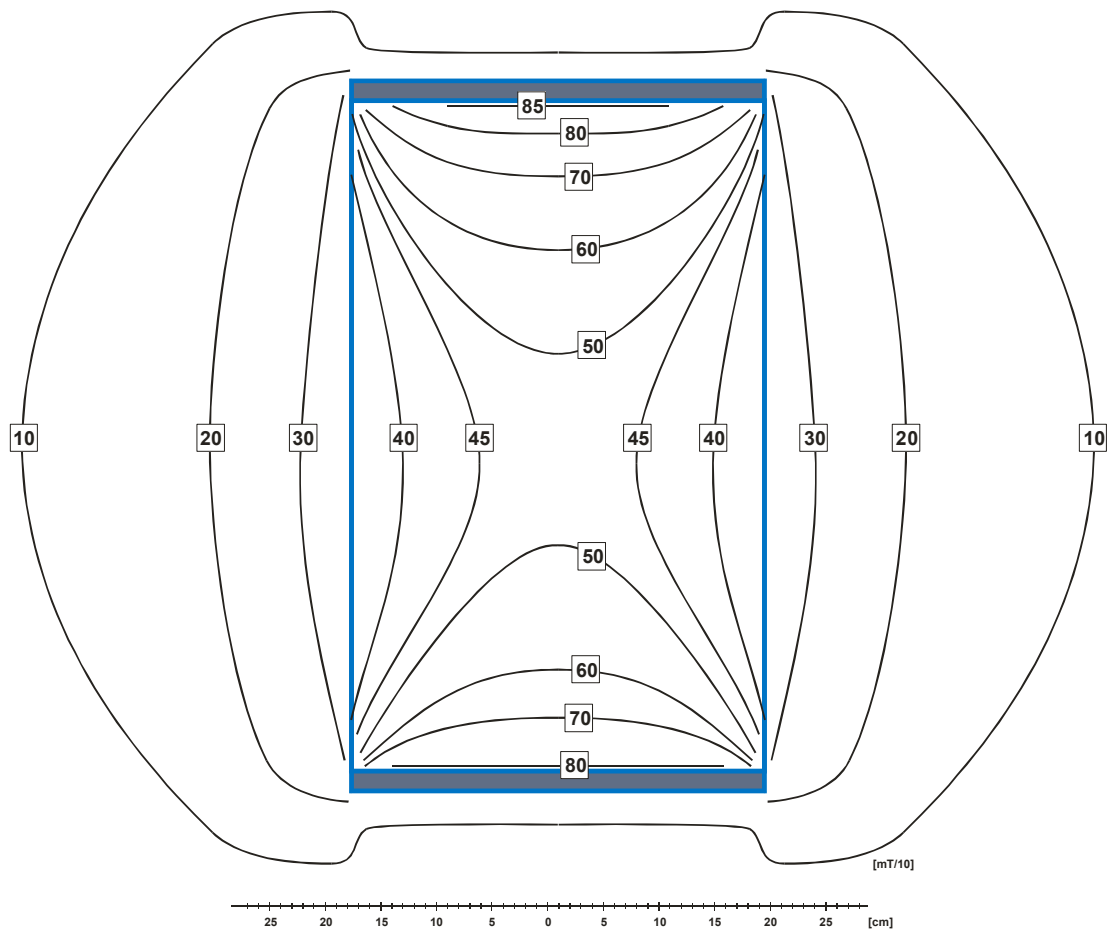

7.6 “LINEAR” APPLICATOR

The surface of the linear applicator is made of harmless and durable leatherette. The same type of leatherette is used on the other applicator types.



Patient / application side of the applicator



Side turned away from the patient (operator side)

The light blue side is marked with a pictograph of the BTL logo and an FMF™ technology label. The intensities on this side of the applicator are much higher than those on the operator side. During operation of the device, the operator should not touch this side of the applicator.

Grey side with no description, logo or label.

7.6.1 TECHNICAL PARAMETERS

Identification - Type:	BTL-239-6
Name:	Linear
Dimensions:	600 x 250 x 20 mm
Weight:	6.10 kg
Max. Intensity of Magnetic Field in Total:	46 mT (460 Gauss)
Resistance of the Applicator:	2.60 Ω

7.6.2 SHAPE OF THE MAGNETIC FIELD OF THE APPLICATOR

The picture shows the shape of the applicator's magnetic field. The unit of the intensity values is **mT/10**, i.e. Gauss, and the values are valid for the maximum current flowing through the applicator.

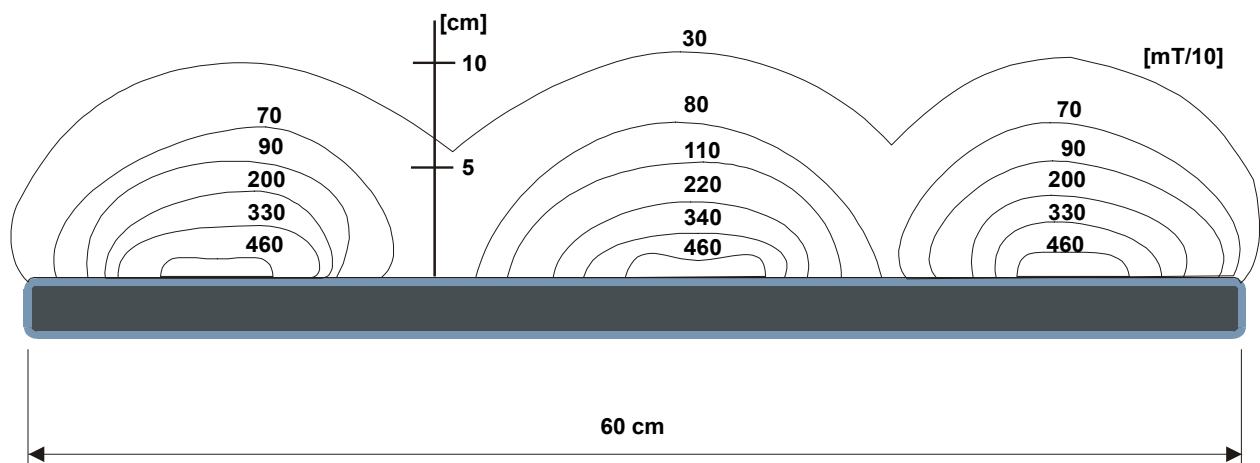

7.7 “SOLENOID 70” APPLICATOR

One part of the construction of this tube-shaped applicator is a rehabilitation couch, put together by sliding, where the basis of the construction of this tube-shaped applicator is a carry tube made of polypropylene (PP), which was chosen because of its favourable mechanical parameters and low weight. A single-layer linear coil is wound onto the tube; the external magnetic field is screened off using **FMF** technology. The design of the applicator was adapted to the requirement to create a linear magnetic field in as large as possible part of the applicator.

7.7.1 TECHNICAL PARAMETERS

Identification - Type:	BTL-239-8
Name:	solenoid 70
Dimensions:	730 x 730 x 300 mm
Inner Width:	685 mm
Inner Height:	480 mm
Weight:	18.0 kg
Max. Intensity of Pulse Magnetic Field:	8.3 mT (85 Gauss)
Resistance of the Applicator:	8.2 Ω

7.7.2 SHAPE OF THE MAGNETIC FIELD OF THE APPLICATOR

The picture shows the shape of the applicator's magnetic field. The unit of the intensity values is **mT/10**, i.e. Gauss, and the values are valid for the maximum current flowing through the applicator.

