

## SECTION 5 - MAINTENANCE

### 5.1 INTRODUCTION

This section contains preventive maintenance instructions, maintenance mode operating procedures, troubleshooting routines, disassembly and reassembly procedures and a comprehensive operational performance test for the IMED® GEMINI PC-2® Volumetric Pump/Controller.

#### WARNING

**Potentially lethal voltages are present within the PC-2 case when the instrument is operated using external AC power. When the case is opened for maintenance action, it is recommended the instrument be operated using the internal battery.**

#### CAUTION

Printed circuit boards (PCBs) are easily damaged when integrated circuits are removed and replaced. Excessive heat applied to the circuit board traces and pads can cause de-lamination of the metal foil and base material. Damage of that type is essentially irreparable; therefore, only low-temperature soldering irons and vacuum solder removal tools should be used when removing and replacing components on PCBs. Leads on integrated circuit components should be cut before attempting unsoldering and removal.

#### NOTE

CMOS devices are sensitive to static electrical charges and may be damaged during repair if the repair activity is not performed in an ESD protected environment using approved ESD protective procedures including personnel grounding.

### 5.2 PREVENTIVE MAINTENANCE

The GEMINI PC-2 is designed and assembled with the goal of minimizing maintenance requirements. The integral microprocessor incorporates a diagnostic routine that monitors the instrument's subsystems and operating parameters. Detection of operating system irregularities or failures that affect the instrument's functional operation activates audio and visual Alarms or Malfunction alerts for operator notification. Problems of this nature are recorded in the non-volatile RAM error log for subsequent use by biotechnical personnel in performing troubleshooting and repair actions.

Maintenance-free operation between regularly scheduled preventive maintenance inspections can be enhanced by performing routine cleaning on an 'as required' basis. The recommended interval for preventive maintenance inspections is once a year based on normal use and operation. Verification of proper operation is the responsibility of the user. At the user's option, such tests and verification may be performed at the factory at nominal cost. The following paragraphs describe in detail the procedures for performing general maintenance on the PC-2.

#### 5.2.1 Cleaning Instructions

#### CAUTION

**Always unplug the AC power cord before cleaning. Do not steam-sterilize/ autoclave the instrument. Do not immerse the PC-2 in any solution.**

Exterior surfaces of the PC-2 may be cleaned using any of the following recommended solutions. This list is considered adequate to permit cleanup of all expected contaminants.

Isopropyl alcohol  
Warm soapy water  
Household Bleach (10% solution, i.e. 1 part household bleach to 9 parts water)

These solutions may be applied using a soft, lint free cloth; a soft bristle brush and/or a cotton swab. Once the contamination has been removed, a cloth soaked with fresh water should be used to rinse the entire instrument removing and diluting all of the residual cleaning solution. Then the entire instrument surface should be completely rinsed using another cloth thoroughly moistened with fresh water. Following the fresh water rinses the instrument must be thoroughly dried with a soft, lint free cloth.

### WARNING

**Prior to reattaching the AC power cord to the instrument, ensure that the male base of the power input module is clean of any electrolyte and dry thoroughly. Check the female contacts on the power cord for contamination; if contaminated, replace the power cord.**

### 5.2.2 Mechanical Inspection

Perform the mechanical inspection described in section 2.2 of this manual plus the following checks:

- Inspect the urethane pumping seal for excessive wear and/or holes every 90 days or 1000 hours of instrument operating time. If damaged or worn replace the seal.
- Perform a pumping mechanism extension spring integrity test by closing the IV set roller clamp while the pump is operating in the Pump mode. If only one spring is functioning the channel will not occlude. Replace damaged or missing spring.

### 5.2.3 Electrical Inspection

Perform the standard electrical inspections described in section 2.3.2 of this manual.

#### 5.2.3.1 Battery Voltage Check

Perform a battery voltage check by either entering the maintenance mode (see section 5.3 for Maintenance Mode operating procedures) and

utilizing the A/D Voltage display's system battery (sys batt) test to check the battery voltage (reading will be 0.5 true voltage), or by following the instrument disassembly procedures described in section 5.5 and connecting a voltmeter across the battery terminals. Battery voltage should read 6.5 volts  $\pm$ 0.3 volts. Batteries installed in instruments primarily operated on battery power should be charged for 12 hours in a non-operating condition, then unplugged and allowed to stabilize for 4 hours prior to performing voltage check. Batteries testing less than 6.2 volts should be subjected to further testing or be replaced.

#### 5.2.3.2 Lithium Battery Check

1. Turn instrument off and unplug AC power cord from outlet.
2. Open the instrument case (see section 5.5.1).
3. Connect a digital voltmeter between ground (TP3) and  $V_{RAM}$  (U8, pin 16) on the Analog Board.
4. Disconnect the battery harness at J6 on the Power Supply Board.
5. After the audio initiates, allow the voltmeter display to stabilize ( $\approx$ 30 seconds), then note the meter reading. Reading should be  $>$ 2.25 Volts.
6. Reconnect the battery harness and press the POWER ON control to silence the audio.
7. If the voltage reading is  $\leq$ 2.25 Volts, the lithium battery (B1) on the Logic Board should be replaced.

### 5.3 MAINTENANCE/DIAGNOSTIC MODE

The PC-2 is configured with a Maintenance/Diagnostic Mode that allows biotechnicians to access the software diagnostic subsystem. Once the Maintenance/Diagnostic Mode is enabled, the biotechnician can use the diagnostic test routines to verify operation of the operator interface features, to operate the pumping mechanisms independent of the alarm/malfunction interrupts, to check system Analog to Digital voltages, to access the error log, to test the lamps and keypad, and to check the input port and serial communications port.

### Integer Keypad/Series 2.xx Software

The Maintenance Mode is utilized for language selection and to set serial communications parameters.

### Fractional Keypad/Series 3.xx Software

The Setup Mode is utilized for language selection and to set communications parameters.

### 5.3.1 Maintenance/Diagnostic Mode Test Sequence

#### Integer Keypad/Series 2.xx Software

The Maintenance Mode test sequence appears in the following order after Maintenance Mode initialization:

TIMEBASE CHECK  
LAMP TEST  
KEYPAD TEST  
ERROR LOG DISPLAY  
MOTOR HOMING TEST  
PUMP TEST  
SERIAL PORT TESTS  
A/D VOLTAGE DISPLAY  
INPUT PORT DISPLAY  
COMMUNICATIONS SETUP  
LANGUAGE SELECTION  
POWERDOWN TEST

#### Fractional Keypad/Series 3.xx Software

The Diagnostic Mode test routines appear in the following sequence after diagnostic mode initialization:

ERROR LOG DISPLAY  
PUMP TEST  
MOTOR HOMING TEST  
A/D VOLTAGE DISPLAY  
INPUT PORT DISPLAY  
LAMP TEST  
KEYPAD TEST  
TIMEBASE CHECK  
SERIAL PORT TESTS  
ROM CRC DISPLAY  
POWERDOWN TEST

### 5.3.2 Maintenance/Diagnostic Mode Operation

#### WARNING

**Prior to operating the PC-2 in the Maintenance Mode ensure that the instrument is not connected to a patient.**

Performing the following procedures as described will provide access to the PC-2's maintenance/diagnostic mode tests:

1. Unplug the AC power cord (it is recommended that maintenance operations be performed using battery power whenever possible).
2. **Software Release V2.13**  
Install the Maintenance Plug in the Nurse Call/Maintenance Plug connector (rear panel).
3. **Software Release V2.33 and Subsequent**  
Press and hold the COMPUTER CONTROL/MONITOR switch.
3. Press the POWER ON control and check:
  - All LEDs and displays - illuminate for 3 seconds then extinguish.

#### Integer Keypad/Series 2.xx Software

- "maintenance v2.xx" - scrolls continuously on the Channel B Operator Information display (2.xx is the installed software version).

#### Fractional Keypad/Series 3.xx Software

- "diagnostics PC2 v3.xx" to exit press <stop> - scrolls continuously on the channel B Operator Information display (v3.xx = installed software version).

4. The PC-2 is now initialized in the Maintenance/Diagnostic Mode.

#### NOTE

#### Software Release V2.13

**The maintenance plug must be installed to change from one test routine to the next and during the motor homing test.**

### 5.3.3 Maintenance Mode Test Suite

The following procedural steps are applicable to both the v2.xx and v3.xx software versions. Where differences occur between the Integer and Fractional keypad controls used to select a test feature, both procedures are described.

#### Software Release V2.13

The press function of the Audio Control switch is used to sequence through the individual maintenance mode tests.

#### Software Release V2.33 and Subsequent

The COMPUTER CONTROL/MONITOR switch is used to sequence through the individual maintenance mode tests.

Each test routine is identified by a scrolled confirmation message. Once the START key is pressed to initiate a specific test routine, the scrolled test identifier is replaced by a statically displayed test phase identifier. The appropriate test select control may be used at any time to deselect the current test and proceed to the next test in the Maintenance Mode test sequence.

### Integer Keypad/Series 2.xx Software

Actuation of the PAUSE/STOP key while a test identifier is scrolling will interrupt the test sequence and powerdown the instrument.

### Fractional Keypad/Series 3.xx Software

Diagnostic mode can only be exited when the Diagnostic mode or powerdown test identifier are scrolling or via a powerdown in the Pump Test routine.

### **TIMEBASE CHECK**



1. Press the appropriate test select control once and check:
  - "timebase check" - scrolls on the Operator Information display.
2. Press START and check:

### Integer Keypad/Series 2.xx Software

- "running" - displays statically
- Channel B VTBI display - alternates between 0 and 1. If displayed value is  $\geq 2$ , "failed" will display on the Operator Information display. Pressing CLEAR will clear the Operator Information display and allow the test to resume.

### Fractional Keypad/Series 3.xx Software

- "swing" - displays statically
- numerical values sequence rapidly in the channel B VTBI display's tenths and units windows.
  - Press PAUSE/STOP once to freeze the display for data recording.
    - "(halted) displays statically in the channel A Operator Information display
    - press PAUSE/STOP again to unfreeze.
  - If the 'swing' value exceeds the expected deviation, a failure is invoked and "FAIL" appears in the channel B Rate display.
  - Pressing CLEAR will allow the test to resume.

3. Press either the  or  controls to toggle the display to the "max" (maximum difference between old and new timer reading since last user keypress), "min" (minimum difference between old and new timer reading since last user keypress) or "dynamic" (current difference between old and new timer readings updated every 10 msec) data modes.

### **LAMP TEST (with AUDIO)**

1. Press the appropriate test select control once and check:
  - "lamp test" - scrolls on Operator Information display.
2. Press START and check:
  - Rate and VTBI displays - Flash sequentially numbers 1 1 1 1 through 9 9 9 9 followed by 1.1.1.1. through 9.9.9.9. (The channel B VTBI Display will not display a decimal point in the Units position; instead the Battery Operation Indicator will illuminate)
  - Operator Information displays - scroll the alphabet in upper case, the numbers "0" - "9", ".", "/", and "?"
  - Controller and Pump delivery mode, Secondary (Piggyback), Communication Traffic and Battery indicator LEDs illuminate steadily during one half of the test cycle
  - Audio alert - sounds once per second.

### **KEYPAD TEST**

1. Press the appropriate test select control once and check:
  - "keypad test" - scrolls on Operator Information display
2. Press START and check:
  - "start" displays statically on Operator Information display
3. Press each key (except POWER ON which provides no response, Audio Control (V2.13) or COMPUTER CONTROL/MONITOR (V2.34 and Subsequent) which always terminates the active test) one at a time and verify that the corresponding nomenclature for the key displays on the channel B Operator Information display.

## ERROR LOG DISPLAY

1. Press the appropriate test select control once and check:
  - "error log display" - scrolls on Operator Information display
2. Press START and check:
  - "empty" (no errors logged) appears on the channel B Operator Information display. In this case proceed to the next maintenance mode test.

or

  - "newest" followed by "nn: cc" [v2.xx] or "nn: ccc" [v3.xx] will display statically on the channel B Operator Information display (nn = number of entry from 00 to 09, cc(c) = error identification code - 00 to 99 [v2.xx] or 00 to 129 [v3.xx]).
3. Press Units (1) digit key to read the error log:
  - Next oldest entry will display in "nn: cc" format or "no older" will appear.
4. Press CLEAR key and check:
  - Error log clears - "wait" displays statically on the Operator Information display during a one second verification stage followed by either "okay" or "fail".

## MOTOR HOMING TEST

1. Press the appropriate test select control once and check:
  - "motor homing test" - scrolls on channel B Operator Information display.

### Software Release V2.13

2. Press START and check:
  - "chan A" displays statically in the Operator Information display.
3. Press START and check:
  - Pumping mechanism operates to seek the 'sync' position (number 7 finger extended) and "homing" displays statically in the Operator Information display.
  - Pumping mechanism stops and "homed" or "failed" displays statically in the Operator Information display.
4. Press START and check:
  - "chan B" displays statically in the Channel B Operator Information display.

5. Press START and check:
  - Pumping mechanism operates to seek the 'sync' position (number 7 finger extended) and "homing" displays statically in the Operator Information display.
  - Pumping mechanism stops and "homed" or "failed" displays statically in the Operator Information display.

### Software Release V2.33 and Subsequent

2. Press START and check:
  - Channel A VTBI displays either a "0" or the last selected home step and "homestep" displays statically in the channel A Operator Information display.
3. Use the Data Entry Controls to select a step (between 0 and 199) for homing. A selection >199 will revert display to "0".
4. Press START and check:
  - Pumping mechanism operates to seek the selected step, "- - -" appears in the VTBI display and "homing" displays statically in the channel A Operator Information display.
  - Pumping mechanism stops and the channel A VTBI display shows the numerical value of the selected homing step
  - "homed" or "failed" displays statically in the channel A Operator Information display
  - Press PAUSE/STOP once to select channel B, then repeat steps #2 through #4.

## PUMP TEST

1. Press the appropriate test select control once and check:
  - "pump test" scrolls on the Operator Information display.

### Software Release V2.13

2. Press START and check:
  - The upper position of either the PUMP or CONTROLLER Delivery Mode/Relative Rate indicator illuminates for each channel
  - "PC-2 Vx.xx" scrolls once across the Operator Information display of both channels

- "ACCESS CHANNEL" scrolls once across the Operator Information display of both channels
  - "MAINTENANCE" scrolls continuously on the Operator Information display of both channels.
3. Use the detailed procedures described in section 3.3.1.1 of this manual or the abbreviated procedures described in the Operator's Reference Guide to set up and operate the instrument.

#### NOTE

The instrument will continue operating independent of any alarm conditions.

#### Software Release V2.33 and Subsequent

2. Press START and check:
  - "normal" displays statically on the channel A Operator Information display.
3. Use the Units (1) digit Data Entry Control to select either the 'normal' or 'pressure' pump test mode. Each actuation will alternately step between normal and pressure. The mode selected will display statically on the channel B Operator Information display.
4. Press START to enable the PC-1 for operation.
  - "MAINTENANCE" scrolls continuously on both Operator Information displays
  - Channel A Rate and VTBI displays show "0"
  - Last selected Pump or Controller delivery mode/Operating indicator will illuminate.
5. Use the procedures described in Section 3.3.1 to set up channel A and operate the instrument.
6. When channel A is operating, press ACCESS CHANNEL B then setup for operation.
7. When in the Pressure mode and after pressing START in step #5 above, check the following:
  - Calculated occlusion pressure voltage threshold for selected infusion parameters is displayed in the RATE display

- Voltage relative to pressure sensed at the Strain Beam displays in the VTBI display.



#### NOTES

Any time the pumping mechanism stops while in the pressure mode, the RATE and VTBI display revert to displaying the selected infusion Rate and decremented VTBI values.

Three motor revolutions following START, the pumping mechanism stops momentarily to check occlusion pressure and then resumes operation. This will result in a one time interruption of the pressure mode presentation with a flash display of the infusion parameters.

To change pump test mode selection, press COMPUTER CONTROL/MONITOR switch once. This will loop the test routine back to step #3 providing a communication cable is NOT connected to the communications data port (RS-232C).

#### Fractional Keypad/Series 3.xx Software

2. Press START and check:
  - "normal" displays statically on the channel A Operator Information display.
3. Use the  or  control to toggle between the "normal" and "pressure" options.
4. Press START to enable the PC-2 for operation.
  - "MAINTENANCE" scrolls continuously on both Operator Information displays
  - Channel A Rate and VTBI displays show " \_ \_ \_ \_"
  - Operating indicator illuminates for last selected delivery mode.
5. Follow the procedures described in Section 3.3.1 to set up channel(s) A and/or B and operate the instrument.
6. When in the Pressure mode and after pressing START in step #5 above, check the following:
  - Calculated occlusion pressure voltage threshold for selected infusion parameters is displayed in the RATE display
  - Voltage relative to pressure sensed at the Strain Beam displays in the VTBI display.

## NOTES

Any time the pumping mechanism stops while in the pressure mode, the RATE and VTBI display revert to displaying the selected infusion Rate and decremented VTBI values.

Three motor revolutions following START, the pumping mechanism stops momentarily to check occlusion pressure and then resumes operation. This will result in a one time interruption of the pressure mode presentation with a flash display of the infusion parameters.

To change pump test mode selection, press COMPUTER CONTROL/MONITOR switch once. This will loop the test routine back to step #3 providing a communication cable is NOT connected to the communications data port (RS-232-C).

### SERIAL PORT TESTS

1. Press the appropriate test select control and check:
  - "serial port tests" scrolls on the Operator Information display.
2. Install Communications Emulator plug in the RS-232-C connector on the rear panel. Test may also be performed using a remote terminal vice a communications plug.
3. Press START and check:
  - "echo" displays statically on the Operator Information display.
4. Press START and check:
  - Each alpha, numeric and symbol in the communications character set is sent with a ? (e.g. A ?) in sequence.
  - "okay" appears in the Operator Information display if each byte sent is echoed within 3 seconds; otherwise "FAIL" appears in the channel B VTBI display.
5. To rerun the test, press CLEAR. This will loop the test sequence back to step 3 above.
6. Press PAUSE/STOP and check:
  - "send" displays statically on the Operator Information display.
7. Press START and check:
  - Byte stream is sent out at the currently selected baud rate. Upon completion "okay" appears on the Operator Information display or "FAIL" appears in the VTBI display.
8. To rerun the test, press CLEAR. This will loop the test sequence back to step 6 above.
9. Press PAUSE/STOP and check:
  - "receive" displays statically on the Operator Information display.
  - Pressing START causes "input ?" to display.
10. (To conduct the "receive" test the PC-2 must be connected to a computer terminal using C2 Communication protocol or another PC-2).

### A/D VOLTAGE DISPLAY

1. Press the appropriate test select control once and check:
  - "A/D voltage display" scrolls on the Operator Information display.
2. Press START and check:
  - "A strain" displays statically on the channel B Operator Information display
  - Channel A strain beam voltage displays in the channel B VTBI display.

### Integer Keypad/Series 2.xx Software



3. Press PAUSE/STOP and check"
  - "B strain" displays statically on the Channel B Operator Information display
  - Channel B strain beam voltage displays in the Channel B VTBI display.
4. Press PAUSE/STOP and check:
  - "sys batt" displays statically on the Channel B Operator Information display
  - System battery voltage + 2 displays on the Channel B VTBI display.
5. Press PAUSE/STOP and check:
  - "V(mains)" displays statically on the Channel B Operator Information display
  - A numerical value ( $\approx 2.50$ ) appears on the Channel B VTBI display if AC power is present; otherwise approximately 00.01 will display.

## NOTE

AC voltage measurement (V mains) is not a quantitative evaluation, but rather a test for presence or absence of AC voltage.

6. Press PAUSE/STOP and check:
  - "V (ref)" displays statically on the Channel B Operator Information display
  - A/D converter reference voltage + 2 (=2.50) is displayed on the Channel B VTBI display.
7. Press PAUSE/STOP and check:
  - "V(audio)" displays statically on the Operator Information display
  - Normally 0000 will display as no audio is active. (Random numerical display may occur, if keypad controls are pressed).



### Fractional Keypad/Series 3.xx Software

3. Press the  control and check:
  - "B strain" displays statically on the Channel B Operator Information display
  - Channel B strain beam voltage displays in the Channel B VTBI display.
4. Press  and check:
  - "sys batt" displays statically on the channel B Operator Information display
  - System battery voltage + 2 displays on the channel B VTBI display.
5. Press  and check:
  - "V(mains)" displays statically on the channel B Operator Information display
  - A numerical value (=2.50) appears on the channel B VTBI display if AC power is present; otherwise approximately 00.01 will display.

## NOTE

AC voltage measurement (V mains) is not a quantitative evaluation, but rather a test for presence or absence of AC voltage.

6. Press  and check:
  - "V (ref)" displays statically on the channel B Operator Information display
  - A/D converter reference voltage + 2 (=2.50) is displayed on the channel B VTBI display.

7. Press  and check:
  - "V(audio)" displays statically on the Operator Information display
  - Normally 00.00 will display as no audio is active. (Random numerical display may occur, if keypad controls are pressed).
8. Press  and check:
  - "V(NiCad)" displays statically of the Operator Information display
  - NiCad battery voltage + 2 displays on the channel B VTBI display (minimum acceptable reading 2.71).

### INPUT PORT DISPLAY

1. Press the appropriate test select control once and check:
  - "input port display" scrolls on the Operator Information display.

## NOTE

The RATE and VTBI display presentations during this test have the same meaning for both channels.

2. Press START and check:
  - "normal" displays statically on the Operator Information display
  - Each digit in the RATE display and the units digit of the VTBI display will present either a "0" or "1" to indicate sensor output as described in the following table:

RATE - 1000 Digit = 0 = 1	AIL	Fluid in sensor Air in sensor
100 Digit = 0 = 1	SCD	Sensor disabled for test MALFUNCTION
10 Digit = 0 = 1	ECD	Air in sensor Fluid in sensor
1 Digit = 0 = 1	MOTOR/ SYNC	Sensor sees Opaque Sensor sees Light
VTBI - 1 Digit = 0 = 1	DOOR	Door Open Door Closed

### Integer Keypad/Series 2.xx Software

3. Press PAUSE/STOP and check:
  - "selftest" displays statically on the Operator Information display
  - Each digit in the RATE display and the units digit of the VTBI display will present either a "0" or "1" to indicate sensor status as described in the following table:



### Fractional Keypad/Series 3.xx Software

3. Press and check:
  - "test" displays statically on the Operator Information display
  - Each digit in the RATE display and the units digit of the VTBI display will present either a "0" or "1" to indicate sensor status as described in the following table:

RATE - 1000 Digit = 0 = 1	AIL	Sensor Malfun Sensor Operating
100 Digit = 0 = 1	SCD	Slide Clamp In Slide Clamp Out
10 Digit = 0 = 1	ECD	Sensor Connected Sensor not Connected
1 Digit = 0 = 1	MOTOR/ SYNC	Sensor sees Opaque Sensor sees Light
VTBI - 1 Digit = 0 = 1	DOOR	Sensor Operating Sensor Malfun

### Integer Keypad/Series 2.xx Software ONLY COMMUNICATIONS SETUP

1. Press appropriate test select control and check:
  - "communications setup" scrolls on the Operator Information display.
2. Press START and check:
  - "serial #" displays statically on the Operator Information display
  - "0000" or currently installed serial number will display on the Channel B VTBI display.
3. Use Data Entry Controls to change the serial number.
4. Press STOP and check:
  - "baudrate" displays statically on the Operator Information display
  - Currently selected baudrate (110, 300, 600, 1200, 2400, 4800 or 9600) will display on the Channel B VTBI display.
5. Use Units (1) digit Data Entry Control to step through and select desired baudrate.
6. Press STOP and check:
  - "parity" displays statically on the Operator Information display
  - Currently selected parity option 'O'(odd), 'E'(even) or 'OFF' displays on the Channel B VTBI display.

7. Use Units (1) digit Data Entry Control to step through and select desired parity option.
8. Press STOP and check:
  - "stopbits" displays statically on the Operator Information display
  - Currently selected stop bits option ('1', '1.5' or '2') displays on the Channel B VTBI display.
9. Use Units (1) digit Data Entry Control to step through and select desired stopbits option.

### Software Release V2.3x LANGUAGE SELECTION

1. Press the appropriate test select control once and check:
  - "language selection" scrolls on the Operator Information display.
2. Press START and check:
  - "currently selected language" displays statically on the Operator Information display.
3. Press the one (1) control once and check:
  - "german" displays statically on the Operator Information display.

Subsequent presses of the (1) control will change the language selected to: "french", then "spanish", and back to "english" on the "a" version EPROM instruments and "italian", then "swedish", then back to "english" on the "b" version EPROM instruments.

### Fractional Keypad/Series 3.xx Software ONLY ROM CRC DISPLAY

1. Press the appropriate test select control once and check:
  - "ROM CRC display" scrolls on the Operator Information display.
2. Press START and check:
  - "n: xxxxx" displays in the Operator Information display (n = ROM block identifier and xxxxx = a hexadecimal reference for use by IMED Software Engineers ONLY).

## POWERDOWN TEST

1. Press the appropriate test select control once and check:
  - "powerdown test" scrolls on the Operator Information display.
2. Press START and check:
  - "POWER" "OFF n" displays statically across the channel A and B Operator Information displays ('n' counts down in seconds from 5 to 1 [v2.xx] or 3 to 1 [v3.xx])
  - One second after 'n' = 1 the instrument shuts down.

### WARNING

**The maintenance plug must be removed prior to returning the instrument to service for patient care.**

## 5.4 TROUBLESHOOTING

The troubleshooting routines presented in the Table 5-1 are correlated directly to the maintenance mode test sequence described in section 5.3. The recommended troubleshooting procedure is to perform the Maintenance Mode test that replicates the reported discrepancy; e.g. if a control key is not functioning - run the Keypad test; if a LED segment is out - run the Lamp test; if the instrument fails to power-up - check the probable causes under Initialization. The corrective actions are listed in a descending order of failure probability. Performing the corrective actions in the sequence provided should reduce repair time and expedite returning the instrument to patient care service.

If the test equipment required to troubleshoot and repair a microprocessor system is not available at your facility, it is recommended the instrument be returned to the factory for repair.

Table 5-1. Troubleshooting/Fault Isolation Guide

Test/Fault	Probable Cause	Corrective Action	
<b>INITIALIZATION</b>			
No LED display	Battery <5.58 Volts	Connect AC Power	
	Battery harness fuse blown	Replace fuse	
	F1 on Power Supply PCB blown	Replace fuse	
	POWER ON switch inoperative	Check Keypad Cable Connector Test/Replace Keypad	
	Transistor Harness Unplugged	Connect Transistor Harness	
	Transistor Lead Disconnected	Repair Broken Wire	
	Lithium/NiCad Battery Failure	Replace Lithium/NiCad Battery	
	Digital Logic Failure	Replace Digital Logic Board	
	No Alarm tone	Audio Harness Disconnected	Connect Audio Harness
		Audio Oscillator Failure	Replace Audio Oscillator
Analog Board Failure ( <b>v2.xx ONLY</b> )		Replace Analog Board	
LEDs stay ON	Digital Logic Failure	Replace Digital Logic Board	
<b>VERSION DISPLAY</b>			
'maintenance V2.13' vice 'PC-2 V2.13'	Maintenance Plug Installed	Remove Maintenance Plug	
	Maintenance Plug not Installed	Install Maintenance Plug	
Model/Version fails to scroll	Maintenance Plug Faulty	Replace Maintenance Plug	
	Digital Logic Failure	Replace Digital Logic Board	
	Display Board Failure	Replace Display Board	
Model/Version display corrupted	Power Supply Board Failure	Replace Power Supply Board	
	Digital Logic Failure	Replace Digital Logic Board	
	Display Board Failure	Replace Display Board	



<b>TIMEBASE CHECK</b>		
Test sequence fails to step	Comm. Harness Disconnected ACCESS Switch Failure Digital Logic Failure	Reconnect Comm. Harness Replace ACCESS switch Replace Digital Logic Board
Test fails to start	Keypad Failure Keypad Interface Failure Digital Logic Failure	Test/Replace Keypad Replace Display Board Replace Digital Logic Board
Test displays ≥'2', & 'failed'	Crystal and Oscillator out of sync.	Replace Digital Logic Board
No test display	Digital Logic Failure Display Board Failure	Replace Digital Logic Board Replace Display Board
<b>LAMP TEST w/AUDIO</b>		
LED segment fails to illuminate	Display Board Failure Digital Logic Failure	Replace Display Board Replace Digital Logic Board
No Audio adjust	Audio Control Switch Failure	Replace Audio Control Switch
<b>KEYPAD TEST</b>		
Key/Display Mismatch or Invalid Key	Decoder Failure	Replace Digital Logic Board
<b>ERROR LOG DISPLAY (See Table 5-2 for a listing and description of Error Log Codes)</b>		
<b>MOTOR HOMING TEST</b>		
Motor Fails to home	Motor Harness Disconnected Digital Logic Failure Analog Board Failure ( <b>v2.xx ONLY</b> )	Reconnect Motor Harness Replace Digital Logic Board Replace Analog Board
Homes to other than Selected Position	Motion Sensor Harness Disconnected Motion Sensor Failure Digital Logic Failure	Reconnect Motion Sensor Harness Replace Motion Sensor Replace Digital Logic Board
<b>PUMP TEST</b>		
Pump Stops: OCCLUDED-FLUID SIDE	Transducer Harness Disconnected Transducer Failure	Replace Transducer Reconnect Transducer Harness

HELP RATE ACCURACY	Digital Logic Board Failure	Replace Digital Logic Board
	Analog Board Failure (v2.xx ONLY)	Replace Analog Board
	Motion Sensor Harness Disconnected	Reconnect Motion Sensor Harness
	Motion Sensor Failure	Replace Motion Sensor
	Motor Harness Disconnected	Reconnect Motor Harness
	Stepper Motor Failure	Replace Stepper Motor
HELP INTERNAL ERROR	Digital Logic Board Failure	Replace Digital Logic Board
	Analog Board Failure (v2.xx ONLY)	Replace Analog Board
	AIL/SCD-Door Sensor Harness Disconnected	Reconnect AIL/SCD-Door Harness
	AIL/SCD Sensor Failure	Replace AIL/SCD Sensor
	Door Sensor Failure	Replace Door Sensor
SERIAL PORT TEST	Digital Logic Board Failure	Replace Digital Logic Board
	"echo" test fail	
	Faulty Communication Plug	Replace Comm Emulator Plug
	Digital Logic Board Failure	Replace Digital Logic Board
A/D VOLTAGE DISPLAY	Power Supply Board Failure	Replace Power Supply Board
	Analog Board Failure (v2.xx ONLY)	Replace Analog Board
	"A or B strain" reading >'0', set not installed	
	Strain Beam Out of Calibration	Recalibrate Strain Beam (see Section 5.7)
	Strain Beam Failure	Replace Strain Beam
	Digital Logic Board Failure	Replace Digital Logic Board
	Analog Board Failure (v2.xx ONLY)	Replace Analog Board
	"A or B strain" reading <'1.0' or >'2.0' with dry pumping segment installed	
Strain Beam Out of Calibration	Replace Strain Beam Recalibrate Strain Beam	
Strain Beam Failure		
Digital Logic Board Failure	Replace Digital Logic Board	
Analog Board Failure (v2.xx ONLY)	Replace Analog Board	



"sys batt" reading <'2.79' or >'3.55'	Power Supply Board Failure  Digital Logic Board Failure Battery Failure Wrong Battery Installed	Check Battery Voltage at in-line fuse  Replace Power Supply Board Replace Digital Logic Board Replace Battery Install I.P.B. Listed Battery
"V(mains) reading <'2.45' or >'2.55'	Power Supply Board Failure Digital Logic Board Failure	Replace Power Supply Board Replace Digital Logic Board
"V(ref)" other than '2.49' ±.02	Power Supply Board Failure Digital Logic Board Failure	Replace Power Supply Board Replace Digital Logic Board

**INPUT PORT TEST**

Normal mode

AIL Sensor - wrong digit for condition

Ultrasonic Emitter/Receiver failure  
Analog Circuit Failure  
Digital Logic Board Failure

Replace AIL/SCD Assembly  
Replace AIL/SCD PC Board  
Replace Digital Logic Board

**NOTE**

The logic for the SCD sensor is reversed in relation to the other sensors. Consequently, in the Normal mode test the SCD sensor is being tested for response to the processor strobe rather than sensor operation. The following SCD sensor operation test is the response expected from the Selftest mode.

SCD Sensor - wrong digit for condition

Light Emitter/Receiver failure  
Analog Circuit Failure  
Digital Logic Failure

Replace AIL/SCD Assembly  
Replace AIL/SCD PC Board  
Replace Digital Logic Board

ECD Sensor - wrong digit for condition

Light Emitter/Receiver Failure  
Communication Cable Failure

Replace ECD  
Reconnect or Replace Communication Cable

Power Supply Board Failure  
Digital Logic Board Failure

Replace Power Supply Board  
Replace Digital Logic Board

Motion Sensor - wrong digit for condition

Sensor Failure  
Digital Logic Board Failure

Replace Sensor  
Replace Digital Logic Board

---

Door Sensor - wrong digit for condition	Sensor Failure	Replace Sensor
	Digital Logic Board Failure	Replace Digital Logic Board

**NOTE**

In the Selftest mode the microprocessor is strobing the sensors in accordance with a software protocol. The digital presentation seen in the RATE and VTBI displays reflect the sensors response to the strobe. If the response is not the expected response a problem exists within the strobe circuitry.

POWER DOWN TEST		
Displays remain On	Digital Logic Board Failure	Replace Digital Logic Board

Table 5-2. Error Log Codes PC-2 Integer Keypad/Series v2.xx Software

Code No.	Description	Meaning	Probable Cause
00	NOT USED		
01	Error Log Failure	Occurs only during startup; the Error Log is reset resulting in loss of resident error log entries.	Logic Board failure Battery Circuit failure Check voltage at RAM VCC: If: <2.0V - NICAD battery failure
02	ROM Failure	Detected during power-up; instrument fails CRC check and powers down immediately <b>WITHOUT</b> alarm.	Logic Board failure
03	NVRAM Failure <u>Software Release V2.49</u> NOT USED	Detected during power-up. The portion of RAM subjected to a CRC test fails. Failure results in loss of previously selected infusion parameters. Default parameters display.	Logic Board failure Battery Circuit failure (see Error Code #1)
04	RAM Failure	During power-up a destructive RAM test is performed on RAM segments not related to infusion parameters. Instrument fails this validity check and powers down <b>WITHOUT</b> alarm.	Logic Board failure
05	<u>Software Release V2.13</u> Sanity Check <u>Software Release V2.33 &amp; Sub.</u> Critical parameters out of range	During power-up, a range check is performed on infusion parameters stored in NVRAM. Failure of this check results in loss of previously selected infusion parameters. Default parameters are displayed.	Logic Board failure Battery Circuit failure (see Error Code #1)
06	Battery failure	During power-up, voltage is checked; measurements >8.0 or <5.30 VDC cause the instrument to immediately power down <b>WITHOUT</b> Alarm.	Battery excessively discharged. Attempt recharge for 4 hours Battery Circuit failure (see Error Code #1) Logic Board failure
07	A/D failure	Occurs during power-up battery check or any subsequent A/D conversion. An A to D interrupt is programmed upon completion of A/D readings. Failure to detect this interrupt within a 60 $\mu$ sec window will cause the instrument to:	<u>Software Release 2.13 ONLY</u> Analog Board failure Logic Board failure



		<p><u>Software Release V2.13</u> power down <b>WITHOUT</b> alarm <u>Software Release V2.33 and Sub.</u> lock up with the error code displayed in the RATE and VTBI.</p>	
08	Invalid Key	Occurs when a keycode is received that is outside of the legal keycode range. An error is logged, "HELP INTERNAL ERROR" is scrolled and the Error Code No. appears in the RATE and VTBI displays. Main processor receives an unassigned keycode from the Display Board.	Display Board failure Logic Board failure
09-11	NOT USED		

**NOTE**

Instruments configured with software release V2.36 and subsequent will **ONLY** display the error code number for Error Codes 12 through 49 in the VTBI display. The Rate display will show a "0".

12	General Software Error	Occurs when a runaway program is detected during a routine check of software logic. <u>Software Release V2.33 through V2.35</u> "HELP INTERNAL ERROR" is scrolled and the Error Code No. appears in the RATE and VTBI displays.	Logic Board
13	Motor Sync Off Ch. A	Occurs when an error >1.5% in a sample of 50 motor revolutions is detected by the motion sensor. "HELP INTERNAL ERROR" is scrolled and the Error Code No. appears in the RATE and VTBI displays.	Pumping Mechanism failure <u>Software Release V2.13 ONLY</u> Analog Board failure
14	Motor Sync Off Ch. B	Occurs when an error >1.5% in a sample of 50 motor revolutions is detected by the motion sensor. "HELP INTERNAL ERROR" is scrolled and the Error Code No. appears in the RATE and VTBI displays.	Pumping Mechanism failure <u>Software Release V2.13 ONLY</u> Analog Board failure
15	No Sync Flag detected Ch. A	Occurs when the motion sensor detects 120 motor steps after failure to confirm motor sync, the motion sensor is inoperative or the motor is not turning. "HELP INTERNAL ERROR" scrolls and the Error Code No. appears in the RATE and VTBI displays.	Logic Board failure Pumping Mechanism failure <u>Software Release V2.13 ONLY</u> Analog Board failure



16	No Sync Flag detected Ch. B	Occurs when the motion sensor detects 120 motor steps after failure to confirm motor sync, the motion sensor is inoperative or the motor is not turning. "HELP INTERNAL ERROR" scrolls and the Error Code No. appears in the RATE and VTBI displays.	Logic Board failure Pumping Mechanism failure <u>Software Release V2.13 ONLY</u> Analog Board failure
17	NOT USED		
18	<u>Software Release V2.49</u> Fast Battery Discharge	After ≥18 hours of continuous operation on AC power, instrument must operate for 2 hours on battery; if unable, a fast battery discharge condition occurs: "HELP INTERNAL ERROR" scrolls, audio alarm sounds, error codes 18 & 38 are logged, 38 displays in VTBI, pumping stops.	Battery Capacity Diminished Battery Charger Circuitry Power Supply Board
19	NOT USED		
20	Door Failure Alarm Ch. A	Occurs when the microprocessor detects a failure of the door sensor. "HELP INTERNAL ERROR" scrolls and the Error Code No. appears in the RATE and VTBI displays.	Logic Board failure Door Harness Assembly failure
21	Door Failure Alarm Ch. B	Occurs when the microprocessor detects a failure of the door sensor. "HELP INTERNAL ERROR" scrolls and the Error Code No. appears in the RATE and VTBI displays.	Logic Board failure Door Harness Assembly failure
22	AIL Failure Alarm Ch. A	Occurs when the microprocessor detects a failure of the AIL sensor. "HELP INTERNAL ERROR" scrolls and the Error Code No. appears in the RATE and VTBI displays.	AIL Board failure AIL/Door Harness failure Logic Board failure
23	AIL Failure Alarm Ch. B	Occurs when the microprocessor detects a failure of the AIL sensor. "HELP INTERNAL ERROR" scrolls and the Error Code No. appears in the RATE and VTBI displays.	AIL Board failure AIL/Door Harness failure Logic Board failure
24-25	NOT USED		
26	Battery Overcharge	Occurs when battery voltage >8.0 VDC is detected during normal instrument operation. "HELP INTERNAL ERROR" scrolls and the Error Code No. appears in the RATE and VTBI displays.	Power Supply Board failure

27	Timer Check Failure	Occurs when the timebase check of the microprocessor in outside of the set tolerance. "HELP INTERNAL ERROR" scrolls and the Error Code No. appears in the RATE and VTBI displays.	Logic Board failure
28	ROM CRC Failure	Occurs when a failure of the CRC check of ROM is detected during normal instrument operation. "HELP INTERNAL ERROR" scrolls and the Error Code No. appears in the RATE and VTBI displays.	Logic Board failure
29	Insanity	Occurs when a range check of RAM infusion parameters detects an out-of-range condition. "HELP INTERNAL ERROR" scrolls and the Error Code No. appears in the RATE and VTBI displays.	Logic Board failure
30	<u>Software Release V2.13</u> NOT USED	Occurs when the slave microprocessor fails to respond within the expected time frame.	Display Board failure
31	<u>Software Release V2.33 &amp; Sub</u> Slave Comm Tout Watchdog Failure	Occurs during power-up when the watchdog timer/main processor link fails to go "+" within $\approx 60$ msec. "HELP INTERNAL ERROR" scrolls across both Operator Information displays and Error Code No. appears in the RATE and VTBI displays.	Logic Board failure
32	<u>Software Release V2.13</u> NOT USED	Occurs when the slave microprocessor detects a failure within a 7-segment display.	Display Board failure
33-34	<u>Software Release V2.33 &amp; Sub.</u> Slave Segment Failure NOT USED		
35	V Ref Failure	Occurs when the main processor, through an A/D channel, is unable to read a 2.5V reference within $\pm 5\%$ . "HELP INTERNAL ERROR" scrolls and the Error Code No. appears in the RATE and VTBI displays.	Battery may be excessively discharged. Recharge battery for 24 hours. Analog Board failure
36	Audio Failure	Occurs when the main processor fails to detect at least 0.2V on an A/D channel following audio circuitry activation. "HELP INTERNAL ERROR" scrolls and the Error Code No. appears in the RATE and VTBI displays.	Logic Board failure Analog Board failure Logic Board failure

37	<p><u>Software Release V2.13</u> NOT USED</p> <p><u>Software Release V2.33 &amp; Sub.</u> Bad Slave Status</p>	<p>The Display processor has reported a processing error, either hardware or software.</p>	<p>Display Board failure</p>
38	<p><u>Software Release V2.13</u> NOT USED</p> <p><u>Software Release V2.33 &amp; Sub.</u> Low Battery II Error</p>	<p>Occurs when an A/D converter reads a battery voltage below 5.4V. "HELP BATTERY" scrolls.</p>	<p>Battery excessively discharged. Attempt recharge for 4 hours.</p> <p>Lead Acid Battery failure</p> <p>Power Supply Board failure</p>
39	<p>NOT USED</p>		
40	<p><u>Software Release V2.13 ONLY</u> Low Battery II Error</p> <p><u>Software Release V2.33/2.36</u> NOT USED</p> <p><u>Software Release V2.49</u> Error Log NVRAM Variables</p>	<p>Occurs when an A/D converter reads a battery voltage below 5.3 Volts. "HELP BATTERY" scrolls across both channels.</p> <p>Error Log partition of partitioned NVRAM experienced a CRC failure between power-down and power-up. Variables in affected partition are initialized to default values and error code is logged. Instrument is usable.</p>	<p>Lead-Acid Battery failure</p> <p>Power Supply Board failure</p> <p>Improper Power-down</p> <p>NVRAM Battery</p> <p>Logic Board</p>
41	<p><u>Software Release V2.13</u> Low Battery III Error</p> <p><u>Software Release V2.33/2.36</u> NOT USED</p> <p><u>Software Release V2.49</u> Fixed Biotech Setup NVRAM Variables</p>	<p>Occurs when a Low Battery II condition has existed for 3 minutes. An error is logged followed by instrument power down WITHOUT audio or visual alarm.</p> <p>Fixed Biotech Setup partition of partitioned NVRAM experienced a CRC failure between power-down and power-up. Variables in affected partition are initialized to default values and error code is logged. Instrument is usable.</p>	<p>Lead-Acid Battery failure</p> <p>Power Supply Board failure</p> <p>Improper Power-down</p> <p>NVRAM Battery</p> <p>Logic Board</p>
42	<p>NOT USED</p>		
43	<p><u>Software Release V2.49</u> Non-Critical Data NVRAM Variables</p>	<p>Non-Critical Data partition of partitioned NVRAM experienced a CRC failure between power-down and power-up. Variables in affected partition are initialized to default values and error code is logged. Instrument is usable.</p>	<p>Improper Power-down</p> <p>NVRAM Battery</p> <p>Logic Board</p>
44	<p>NOT USED</p>		

45	<u>Software Release V2.49</u> Critical State NVRAM Variables	Critical State partition of partitioned NVRAM experienced a CRC failure between power-down and power-up. Variables in affected partition are initialized to default values and error code is logged. Instrument is usable.	Improper Power-down NVRAM Battery Logic Board
46	<u>Software Release V2.49</u> Critical Data NVRAM Variables	Critical Data partition of partitioned NVRAM experienced a CRC failure between power-down and power-up. Variables in affected partition are initialized to default values and error code is logged. Instrument is usable.	Improper Power-down NVRAM Battery Logic Board
47	NOT USED		
48	Strain Beam Failure Ch. A	Occurs when the microprocessor does not detect at least 100 mV of variance between the highest and lowest readings taken during 2 revolutions of the motor mechanism.	Strain beam failure Logic Board failure
49	Strain Beam Failure Ch. B	Occurs when the microprocessor does not detect at least 100 mV of variance between the highest and lowest readings taken during 2 revolutions of the motor mechanism.	Strain beam failure Logic Board failure

Table 5-2a. Error Log Codes PC-2 Fractional Keypad/Series 3.xx Software

Code No.	Description	Meaning	Probable Cause
00	NOT USED		
01	Error Log Failure	Occurs only during startup; the Error Log is reset resulting in loss of resident error log entries.	Logic Board failure Battery Circuit failure Check voltage at RAM VCC: If: <2.0V - NICAD battery failure
02-03	NOT USED		
04	RAM Failure	During power-up a destructive RAM test is performed on RAM segments not related to infusion parameters. Instrument fails this validity check and powers down <b>WITHOUT</b> alarm.	Logic Board failure
05	NOT USED		
06	Battery failure	During power-up, voltage is checked; measurements >8.0 or <5.30 VDC cause the instrument to immediately power down <b>WITHOUT</b> alarm.	Battery excessively discharged. Attempt recharge for 4 hours Battery Circuit failure (see Error Code #1)
07	A/D failure	Occurs during power-up battery check or any subsequent A/D conversion. An A to D interrupt is programmed upon completion of A/D readings. Failure to detect this interrupt within a 35 $\mu$ sec window will cause the instrument to: <b>Software Release V2.13</b> power down <b>WITHOUT</b> alarm <b>Software Release V2.33 and Sub.</b> lock up with the error code displayed in the Rate and VTBI.	Logic Board failure Logic Board failure
08	Invalid Key	Occurs when a keycode is received that is outside of the legal keycode range. An error is logged, "HELP INTERNAL ERROR" is scrolled and the Error Code No. appears in the RATE and VTBI displays. Main processor receives an unassigned keycode from the Display Board.	Display Board failure Logic Board failure

09	ROM Bank 0 CRC Failure	A runtime CRC value is calculated for each of the four ROM banks. If the runtime CRC does not match the precalculated CRC value stored in the last 2 bytes of a ROM, ROM corruption is suspected; HELP INTERNAL ERROR scrolls, Error Code displays in VTBI, Rate displays "0", alarm sounds, pump stops.	Bad ROM Chip
10	ROM Bank 1 CRC Failure		Logic Board failure
11	ROM Bank 2 CRC Failure		
12	ROM Bank 3 CRC Failure		
13	Motor Sync Off Ch. A	Occurs when an error >1.5% in a sample of 50 motor revolutions is detected by the motion sensor. "HELP INTERNAL ERROR" is scrolled and the Error Code No. appears in the RATE and VTBI displays.	Pumping Mechanism failure
14	Motor Sync Off Ch. B	Occurs when an error >1.5% in a sample of 50 motor revolutions is detected by the motion sensor. "HELP INTERNAL ERROR" is scrolled and the Error Code No. appears in the RATE and VTBI displays.	Pumping Mechanism failure
15	No Sync Flag detected Ch. A	Occurs when the motion sensor detects an error >125% in the number of motor steps per revolution, the motion sensor is inoperative or the motor is not turning. "HELP INTERNAL ERROR" scrolls and the Error Code No. appears in the RATE and VTBI displays.	Logic Board failure Pumping Mechanism failure
16	No Sync Flag detected Ch. B	Occurs when the motion sensor detects an error >125% in the number of motor steps per revolution, the motion sensor is inoperative or the motor is not turning. "HELP INTERNAL ERROR" scrolls and the Error Code No. appears in the RATE and VTBI displays.	Logic Board failure Pumping Mechanism failure
17	NOT USED		
18	Fast Battery Discharge	If after a 10 hour charging, the pump fails to operate for ≥2.5 hours. Error occurs in conjunction with a Low Battery II condition. Error codes 18 & 38 are logged, HELP BATTERY is scrolled, Error code is displayed in VTBI, rate displays "0", pump stops, and all controls are disabled except PAUSE/STOP.	Battery Power Supply Board

19	Improper Power-down	Instrument powers-down without use of PAUSE/STOP control, i.e. watchdog or battery failure. On subsequent power up, error code 19 will be logged and HELP INTERNAL ERROR will scroll. Error code is displayed in VTBI, rate displays "0", alarm sounds, all controls are disabled except PAUSE/STOP.	Battery Logic Board failure
20	Door Sensor Failure Ch. A	Occurs when the microprocessor detects a failure of the door sensor. "HELP INTERNAL ERROR" scrolls and the Error Code No. appears in the RATE and VTBI displays.	Logic Board failure Door Harness Assembly failure
21	Door Sensor Failure Ch. B	Occurs when the microprocessor detects a failure of the door sensor. "HELP INTERNAL ERROR" scrolls and the Error Code No. appears in the RATE and VTBI displays.	Logic Board failure Door Harness Assembly failure
22	AIL Failure Alarm Ch. A	Occurs when the microprocessor detects a failure of the AIL sensor. "HELP INTERNAL ERROR" scrolls and the Error Code No. appears in the RATE and VTBI displays.	AIL Board failure AIL/Door Harness failure Logic Board failure
23	AIL Failure Alarm Ch. B	Occurs when the microprocessor detects a failure of the AIL sensor. "HELP INTERNAL ERROR" scrolls and the Error Code No. appears in the RATE and VTBI displays.	AIL Board failure AIL/Door Harness failure Logic Board failure
24-25	NOT USED		
26	Battery Overcharge	Occurs when battery voltage >8.0 VDC is detected during normal instrument operation. Pump stops, "HELP INTERNAL ERROR" scrolls and the Error Code No. appears in the RATE and VTBI displays.	Power Supply Board failure
27	Timer Check Failure	Occurs when the timebase check of the microprocessor is outside of the set tolerance. "HELP INTERNAL ERROR" scrolls and the Error Code No. appears in the Rate and VTBI displays.	Logic Board failure
28-29	NOT USED		



30	Slave Communications Failure	Display processor fails to respond to a query from the Logic processor. Pumping stops, the error code is logged and displayed in VTBI, rate displays "0", HELP INTERNAL ERROR scrolls, alarm sounds and all controls except PAUSE/STOP are disabled.	Display Board failure
31-34	NOT USED		
35	V Ref Failure	Occurs when the main processor, through an A/D channel, is unable to read a 2.5V reference within $\pm 5\%$ . "HELP INTERNAL ERROR" scrolls and the Error Code No. appears in the RATE and VTBI displays.	Battery may be excessively discharged. Recharge battery for 24 hours. Logic Board failure
36	Audio Failure	Occurs when the main processor fails to detect at least 0.5V on an A/D channel following audio circuitry activation. "HELP INTERNAL ERROR" scrolls and the Error Code No. appears in the RATE and VTBI displays.	Logic Board failure
37	Bad Slave Status	The Display processor has reported a processing error, either hardware or software.	Display Board failure
38	Low Battery II	Occurs when an A/D converter reads a battery voltage below 5.4V. "HELP BATTERY" scrolls.	Battery excessively discharged. Attempt recharge for 4 hours. Lead Acid Battery failure Power Supply Board failure
39	General Software Error	Calling sequence in main software loop or case statement index is corrupted. Pump stops, error code is logged and displayed in VTBI, rate displays "0", HELP INTERNAL ERROR scrolls, alarm sounds, all controls except PAUSE/STOP are disabled.	Logic Board failure
40	Error Log NVRAM Variables	Each NVRAM partition performs a CRC or validity check and stores the value prior to shutdown. Power up calculated CRC must match stored value or NVRAM corruption	(Normal if EPROM replaced)
41	Fixed Biotech Setup NVRAM		NVRAM Battery
42	Non-Critical State NVRAM		
43	Non-Critical Data NVRAM		

44	NOT USED	is assumed. Specific error code is logged, all variables in affected NVRAM partition are initialized to default values. Instrument is then ready for normal use.	Improper Powerdown
45	Critical State NVRAM		
46	Critical Data NVRAM		
47	NOT USED		
48	Strain Beam Failure Ch. A	Occurs when the microprocessor does not detect at least 100 mV of variance between the highest and lowest readings taken during 2 revolutions of the motor mechanism.	Strain beam failure Logic Board failure
49	Strain Beam Failure Ch. B	Occurs when the microprocessor does not detect at least 100 mV of variance between the highest and lowest readings taken during 2 revolutions of the motor mechanism.	Strain beam failure Logic Board failure
50	ROM Bank 1 Reset Error	If ROM Bank 0 is not the first ROM bank accessed, ROM Bank reset error has occurred. Appropriate error code is logged, "ROMx rst" displays in Operator Information display, alarm sounds, instrument enters a watchdog condition.	Logic Board failure
51	ROM Bank 2 Reset Error		
52	ROM Bank 3 Reset Error		
53-61	NOT USED		
62	Power-Up Audio Failure	Audio transducer input voltage at power-up is <0.2 volts; error code is logged and displayed in VTBI, rate displays "0", pump stops, HELP INTERNAL ERROR scrolls, all controls except PAUSE/STOP are disabled.	Logic Board failure
63	NOT USED		
64	NVRAM Battery	A/D converter reads NVRAM battery voltage of <2.4 volts. Error code is logged and displayed in the VTBI, rate displays "0", pump stops, HELP BATTERY scrolls, alarm sounds and all controls except PAUSE/STOP are disabled.	NVRAM Battery Logic Board failure
65-70	NOT USED		

71	Motor Revolution Error Ch A	Rate dependent motor revolution time exceeds calculated value by >12% for two motor revolutions. Error code is logged and displayed in the VTBI, rate displays "0", pump stops, HELP INTERNAL ERROR scrolls and all controls except PAUSE/STOP are disabled.	Pump Mechanism motor failure Logic Board failure
72	Motor Revolution Error Ch B	Rate dependent motor revolution time exceeds calculated value by >12% for two motor revolutions. Error code is logged and displayed in the VTBI, rate displays "0", pump stops, HELP INTERNAL ERROR scrolls and all controls except PAUSE/STOP are disabled.	Pump Mechanism motor failure Logic Board failure
73	Rate Value Corruption Error	Discrepancy exists between rate value sent to the Display Board and the value used to calculate motor table entries. Error code is logged and displayed on VTBI, rate displays "0", pump stops, HELP INTERNAL ERROR scrolls, alarm sounds and all controls except PAUSE/STOP are disabled.	Logic Board failure Display Board failure
74	Motor Table Calculation Error	Stepper motor table summation for selected rate is outside of predetermined range for that rate. Error code is logged and displayed on the VTBI, rate displays "0", pump stops, HELP INTERNAL ERROR scrolls, alarm sounds and all controls except PAUSE/STOP are disabled.	Logic Board failure
75	Stuck Bits Error	An error in the high speed timer, strobe timer, slow speed timer or step interval has occurred. Error code is logged and displayed on the VTBI, rate displays "0", pump stops, HELP INTERNAL ERROR scrolls and all controls except PAUSE/STOP are disabled.	Logic Board failure
76	NOT USED		

77	Illegal ROM Bank Request	An illegal ROM Bank number was used in an attempt to switch ROM banks or a ROM bank verification failed during a switching operation. Error code is logged and displayed on the VTBI, rate displays "0", pump stops, HELP INTERNAL ERROR scrolls and all controls except PAUSE/STOP are disabled.	Logic Board failure
78-80	NOT USED		
81	Current Rate out of range	A specific variable has been detected outside of prescribed limits during instrument operation (runtime). Specific error code is logged and displayed on the VTBI, rate displays "0", pump stops, HELP INTERNAL ERROR scrolls, alarm sounds and all controls except PAUSE/STOP are disabled.	Logic Board failure
82	Piggyback Rate out of range		
83	Current VTBI out of range		
84	Piggyback VTBI out of range		
85	Tot Vol Infused out of range		
86	SEC Vol Infused out of range		
87	Motor step no. out of range		
88	NOT USED		
89	Error in fractional mode rate, VTBI, etc. out of range		
90	NOT USED		
91	Current Rate out of range	A specific variable has been detected outside of prescribed limits during power-up. Specific error code is logged and display on the VTBI, rate displays "0", pump stops, HELP INTERNAL ERROR scrolls, alarm sounds and all controls except PAUSE/STOP are disabled.	Logic Board failure
92	Piggyback Rate out of range		NVRAM Battery
93	Current VTBI out of range		
94	Piggyback VTBI out of range		
95	Tot Vol Infused out of range		
96	SEC Vol Infused out of range		
97	Motor step no. out of range		
98	RAM copy of ROM-CRC is in error		
99	Error in fractional mode rate, VTBI, etc. out of range		
100	ROM Bank 0 Start Failure	At power-up the ROM CRC calculation does not match the stored "Correct" CRC value. The specific error code is logged and the instrument is shutdown <b>WITHOUT</b> alarm.	Logic Board failure
101	ROM Bank 1 Start Failure		
102	ROM Bank 2 Start Failure		
103	ROM Bank 3 Start Failure		
104-123	NOT USED		

124	Watchdog Timer Sanity Failure	A watchdog test failure has occurred. Error code is logged and the instrument enters a watchdog state.	Logic Board failure
125	Watchdog Period Test Failure		
126	NOT USED		
127	Failure to reach ROM Bank 1	ROM ID number does not match ID number of schedule ROM Bank during ROM bank switching operation. Error code is logged and displayed in VTBI, rate displays "0", pump stops, HELP INTERNAL ERROR scrolls, alarm sounds and all controls except PAUSE/STOP are disabled.	Logic Board failure
128	Failure to reach ROM Bank 2		
129	Failure to reach ROM Bank 3		

### 5.5.2.3 Door Sensor Assembly Removal (Figure 6-2)

1. Use a #1 Phillips screwdriver to remove the screw and washer that attach the door sensor harness to the front case.

### 5.5.2.4 AIL/SCD Assembly Removal and Disassembly (Figure 6-2)

#### NOTE

Removal of the pumping mechanism (see paragraph 5.5.2.2) is required to provide access to the AIL/SCD Assembly mounting screws.

1. Use a #1 Phillips screwdriver to remove the four screws and washers that attach the AIL/SCD assembly to the front case.
2. Tilt the front case assembly to the upright position and open the door latch. This will prohibit the seal from engaging the ramped projections on the slide clamp housing.
3. Remove the AIL/SCD assembly from the front case.

### 5.5.2.5 Transducer Assembly Removal (Figure 6-2)

#### NOTE

Removal of the pumping mechanism (see paragraph 5.5.2.2) is required to provide access to the Transducer Assembly mounting screws.

The transducer is not supported below the assembly level. **DO NOT ATTEMPT TO REPAIR AND REINSTALL.**

1. Use a #1 Phillips screwdriver to remove the four epoxy lock screws and special washers (square) that attach the transducer assembly to the front case.
2. Slip the transducer harness clear of the adhesive backed wire clip that holds the harness to the front case.
3. Lift the transducer assembly out of the front case.

#### NOTE

When reinstalling the transducer assembly, IMED fixture P/N 1320-4077 must be slipped over and seated on the transducer assembly to ensure proper alignment. Position the special washers, start, then tighten the four mounting screws to Table 5-3 Torque Values. Perform Section 5.7 Calibration.

### 5.5.2.6 Anchor Bracket Assembly Removal (Figure 6-2)

1. Use a #1 Phillips screwdriver to remove the screw that attaches the ground wire to the anchor bracket.
2. Use pliers to grasp the washer, then press down and compress the spring, and remove the hairpin cotter. Carefully release the downward press on the spring allowing it to expand to full length, then remove the washer and spring from the anchor bracket.
3. Tilt the front case to the upright position, open the door latch, swing the door open and remove the anchor bracket.

### 5.5.2.7 Access Door Assembly Removal and Disassembly (Figures 6-2 and 6-3)

1. Unlatch and open the door.
2. Use a 1/32 inch or 1 mm drift punch to depress the tip of the upper hinge pin below the lower surface of the front case hinge pivot projection, then ease the upper edge of the door away from the front case while using a finger to trap the hinge pin in its recess. Once the hinge pin is clear, lift the door out of the lower hinge pivot projection.

#### NOTE

The dowel pin that attaches the cam lock to the door is retained by a spring washer. When removed, the spring washer must be replaced.

3. Use a 1/8 inch drift punch to knock out the dowel pin that attaches the cam lock assembly (door latch) to the door.

4. Use a 1/8 inch drift punch to knock out the spring pin that attaches the sear to the cam lock.
5. Use a 1/16 inch drift punch to knock out the spring pin that attaches the cam lock pawl to the door.

#### 5.5.2.8 Pump Seal Removal (Figure 6-2)

##### NOTE

To remove the pump seal bezel, it is necessary to first remove the pumping mechanism (see paragraph 5.5.2.2) to provide access to the bezel grounding connection.

1. Use a 1/4 inch offset wrench or needle nose pliers to hold the nut on the bezel ground wire connection while removing the screw from the front side with a #1 Phillips screwdriver.
2. Remove the remaining nine screws from the bezel.
3. Use a straight slot screwdriver to pry the top edge of the bezel out of the front case recess.
4. Pull the urethane pump seal from the front case.

##### NOTES

Prior to installing a replacement pump seal, coat the inside of the seal with 100  $\mu$ L of Silicone oil (P/N 1025-100).

When reinstalling the pump seal assembly, torque the bezel mounting screws to 3 lb-in.

#### 5.5.2.9 Snap Bracket Removal (Figure 6-2)

1. Use a #1 Phillips screwdriver to remove the screw that attaches the snap bracket to the front case.

#### 5.5.2.10 Keypad/ESD Shield Assembly Removal (Figure 6-2)

##### NOTE

The laminated front label/keypad/ESD shield assembly is manufactured with an adhesive backing which bonds it to the front case. Once removed, it is not reusable.

1. Use a #1 Phillips screwdriver to remove the screw that connects the ESD shield grounding tab to the threaded lug on the front case.
2. Peel the laminated front label/keypad and copper ESD shield from front case and dispose of it.

#### 5.5.2.11 DELETED

#### 5.5.3 Rear Case Disassembly

The following disassembly procedures are sequenced for complete disassembly of the rear case. All subassemblies installed on the interior rear case are directly accessible and can be independently removed and replaced.

##### 5.5.3.1 Battery Assembly Removal (Figure 6-11)

1. Lay the rear case down on the working surface.
2. Use a #4 straight slot screwdriver to remove the two screws and lock washers that attach the battery retention strap to the rear case and remove the strap.
3. Lift the battery out of the rear case.

##### 5.5.3.2 Audio Harness Assembly Removal (Figure 6-11)

1. Use a #1 Phillips screwdriver to remove the two screws and washers that attach the audio oscillator to the rear case.
2. Lift the audio harness assembly out of the rear case.

Table 5-3. Table of Torque Values

Functional Application	Item Description	Figure/Item Reference	Torque Value
FINAL ASSEMBLY Front Case to Rear Case	#10-32 x 3/8	6-1 / 7	7 lb-in
FRONT CASE			
Multicard Assy to Front Case	#4-40 x 3/4	6-2 / 6 & 7	3 lb-in
ESD Shield Ground to Front Case	#4-40 x 3/16	6-2 / 12	3 lb-in
Bezel to Front Case	#4-40 x 1/2	6-2 / 15	3 lb-in
Snap Bracket to Front Case	#4-4 x 3/16	6-2 / 18	3 lb-in
Pumping Mechanism to Front Case	#6-32 x 3/8 EL	6-2 / 21	2 lb-in [v2.xx]
	#6-32 x 3/8 (with lock washer)	6-2 / 21	7 lb-in [v3.xx]
Transducer Assy. to Front Case	#4-40 x 1/4 EL	6-2 / 23	2 lb-in
Door Sensor to Front Case	#4-40 x 1/4	6-2 / 27	3 lb-in
AIL/SCD Assy. to Front Case	#4-40 x 1/4	6-2 / 31	3 lb-in
Ground Harness to Anchor Bracket	#4-40 x 3/16	6-2 / 39	3 lb-in
PUMPING MECHANISM			
Bearing Cup to Top Plate Assy.	#6-32 x 1 EL	6-4 / 8	3 lb-in
Left to Right Pump Housing	#6-32 x 3/8 EL	6-4 / 28	3 lb-in
Pump Housing to Top Plate Assy.	#4-40 Shldr EL	6-4 / 24	8 lb-in
Vibration Mounts to Motor Housing	Rubber Mount	6-4 / 19	Finger Tight
Motor Bracket to Vibration Mounts	#4-40 x 5/16	6-4 / 15	5 lb-in
Motor Bracket to Top Plate Assy.	#4-40 x 5/16	6-4 / 15	5 lb-in
Motion Sensor to Top Plate Assy.	#4-40 x 3/8	6-4 / 3	3 lb-in
REAR CASE			
Audio Harness Assy to Rear Case	#4-40 x 1/2	6-11 / 17	3 lb-in
Transistor Harness to Rear Case	#4-40 x 1/4	6-11 / 24	5 lb-in
Audio Control Switch to Rear Case	Nut	6-11 / No Ref	3 lb-in

**CAUTION**

When epoxy lock (EL) screws are removed always replace with a new epoxy lock screw. Replacement screws are available from IMED Service Centers. **USE ONLY LOCTITE 425 TO IMMOBILIZE A STANDARD SCREW.** If a lock washer is installed **DO NOT** use glue.

**5.7 STRAIN BEAM CALIBRATION**

Anytime a Strain Beam (pressure transducer) assembly has been removed from the front case assembly or replaced, the Analog Board [v2.xx] or Logic/Analog board [v3.xx] is changed or a component in the strain beam functional schematic (see figure 4-5) is replaced; the following calibration/adjustment procedure **MUST** be performed prior to returning the instrument to patient care service.



## 5.7.1 Calibration Equipment Requirements

### NOTE

Calibrated tubing must be obtained from the IMED San Diego Service Center.

Carefully follow the special handling, installation and storage instructions provided with each calibrated tubing.

1. Calibrated tubing with specified LOW and HIGH Reference Voltage constants (IMED P/N 3299-100).
2. Digital Voltmeter with 0.1 millivolt resolution.
3. Digital Pressure Gauge, 0 - 30 psi range and 0.1 psi resolution or a Mercury (Hg) manometer.
4. Stopwatch.
5. Maintenance Plug (PC-2s with software **V2.13 only**).
6. Regulated, stable air source adjustable to 10  $\pm 0.1$  psi.

### WARNING

The following calibration procedure is performed with the instrument case open. The preferred procedure is to perform the calibration using a fully charged battery. If AC power is used, potentially lethal voltages are present in the rear case assembly. Use caution when connecting meter leads to the Analog PC Board.

## 5.7.2 Calibration Procedures

1. Open the Main Case (see Section 5.5.1).
2. If a fully charged battery is not available, connect the AC power cord.
3. Install the Maintenance Plug (**Software Release V2.13**) or press and hold the COMPUTER CONTROL/MONITOR switch (Software Release V2.33 and Subsequent).
4. Press the POWER ON control.
5. The instrument will initialize in the Maintenance Mode. Note and record the installed software version that is scrolled on the Operator Information display.

### NOTE

The front case must be in the Upright position when this calibration procedure is performed. **DO NOT** put any pressure on the pumping chamber access door during the calibration process.

### Software Release V2.13

6. Attach the voltmeter Ground lead (-) to TP #3 on the Analog Board (see figure 6-9) and the positive (+) lead to pin #1 on U4 (for channel A) or U5 (for channel B).
7. Rotate the pumping mechanism encoder wheel for the channel being calibrated to the position shown:

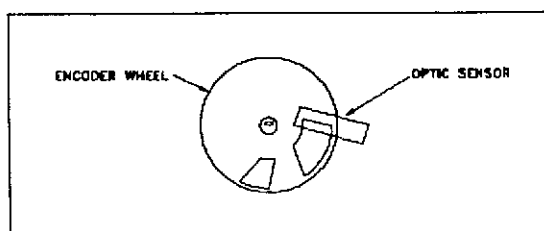

### CAUTION

Observe the special handling and installation instructions provided with the calibrated tubing. Ensure the alignment index mark on the tubing's upper fitment is visible when installed. Any distortion of the silicone tubing will affect the voltage index (VI) values. Store the calibrated disposable in the protective cover when not in use.

8. Install the calibrated disposable in the pumping chamber of the channel to be calibrated, close the door and wait 30 seconds. Ensure distal end is vented to ambient pressure.
9. Adjust the ZERO potentiometer (R13 for channel A or R33 for channel B) to give an output voltage of 0  $\pm 5.0$  millivolts. Ignore any voltage drift after the potentiometer is correctly set.

10. Connect the positive (+) voltmeter lead to TP #1 (for channel A) or TP #2 (for channel B).
11. Apply and maintain  $10.0 \pm 0.1$  psi to the distal end of the calibration disposable, then wait a minimum of 15 seconds.
12. Adjust the SPAN potentiometer (R17 for channel A or R36 for channel B) until the voltage output is equal to the differential voltage for the calibrated disposable (HIGH minus LOW Reference voltage for your instrument's installed software version, i.e. V2.13 - 3.0 volts).
13. Adjust the ZERO potentiometer (R13 for channel A or R33 for channel B) until the voltage is equal to the HIGH Reference voltage ( $\pm 0.01$  volts) for the installed software version.
14. Release the pressure, ensuring the distal end is vented to ambient pressure.
15. At  $30 \pm 5$  seconds, read the output voltage. **This voltage must be equal to the LOW Reference voltage ( $\pm 0.1$  volts) provided with the calibrated disposable; if it is not, repeat steps 7 and 9 through 15.**
16. Press the PAUSE/STOP control to power down the instrument.

### WARNING

**The Maintenance Plug must be removed prior to returning the instrument to service for patient care.**

17. Remove the Maintenance Plug.
18. Perform a Comprehensive Operational Performance Test (See Section 5.8).

### Software Release V2.33 and Subsequent

6. Actuate the COMPUTER CONTROL/MONITOR switch to select the Motor Homing Test.
7. Press START, then use the Data Input Controls to select Motor Step 150 for the channel to be calibrated.
8. Press START. (Encoder wheel position should match figure shown in V2.13 procedure).

9. Attach the DVM positive (+) lead to pin #1 of U4 (for channel A) or pin #1 of U5 (for channel B) and the ground (-) lead to TP#3 on the Analog Board.
10. Actuate the COMPUTER CONTROL/MONITOR switch to select A/D Voltage Test, then press START.
  - "A strain" will appear on the Operator Information display (press PAUSE/STOP control once to select "B strain").



### CAUTION

**Observe the special handling and installation instructions provided with the calibrated tubing. Ensure the alignment index mark on the tubing upper fitment is visible when installed. Any distortion of the silicon tubing will affect the voltage index (VI) values. Store the calibrated disposable in the protective cover when not in use.**

11. Install the calibrated disposable in the pumping chamber, close the door and wait 20 seconds. Ensure distal end is vented to ambient pressure.
12. Adjust the ZERO potentiometer (R13 for channel A or R34 for channel B) to give a stable output of  $0 \pm 3.0$  mV. Following adjustment, disconnect the DVM.
13. Connect the positive (+) voltmeter lead to TP#1 (for channel A) or TP#2 (for channel B).
14. Apply and maintain  $10.0 \pm 0.1$  psi to the distal end of the calibration disposable. Wait a minimum of 15 seconds before proceeding.
15. Adjust the SPAN potentiometer (R17 for channel A or R36 for channel B) until the VTBI display reads  $2.50 \pm 0.01$ .
16. Adjust the ZERO potentiometer (R13 for channel A or R34 for channel B) until the VTBI display equals the sum of the calibrated disposable's zero pressure index  $VI_0$  plus  $2.50 \pm 0.01$ . Record the final voltage value.
17. Release the pressure, ensuring the disposable's distal end is vented to ambient pressure.

18. After  $30 \pm 5$  seconds, read the VTBI display. This reading must equal  $VI_0 \pm 0.01$ ; if it does not repeat steps 7 through 17. Record the actual voltage value.
19. Open the door.
20. Ensure the VTBI reading drops to either 0.00 or 0.01.
21. Using your finger, gently press against the strain beam finger with sufficient pressure to fully deflect the strain beam; confirm the strain beam voltage in the VTBI display is between 4.90 and 5.15. **If the reading is not within this range, contact IMED Technical Service.**
22. Press COMPUTER CONTROL/MONITOR switch, then PAUSE/STOP to power down the instrument.
23. Perform a Comprehensive Operational Performance Test (see Section 5.8).

### Fractional Keypad/Series v3.xx Software

6. Actuate the COMPUTER CONTROL/MONITOR switch to select the Motor Homing Test.
7. Press START, then use the Data Input Controls to select Motor Step 150 for the channel to be calibrated.
8. Press START. (Encoder wheel position should match figure shown in V2.13 procedure).
9. Attach the DVM positive (+) lead TP5 (for channel A) or TP4 (for channel B) and the ground (-) lead to TP#3 on the Logic/Analog Board.
10. Actuate the COMPUTER CONTROL/MONITOR switch to select A/D Voltage Test, then press START.
  - "A strain" will appear on the Operator Information display.
11. Press the  control until " $V_{REF}$ " appears in the Operator Information display. Ensure the VTBI display shows a value between 2.47 and 2.53. **If the reading is not within this range, contact IMED Technical Service.**
12. Press the  control until "A strain" appears in the Operator Information display. (Press the  control once to select "B strain").

### CAUTION

**Observe the special handling and installation instructions provided with the calibrated tubing. Ensure the alignment index mark on the tubing upper fitment is visible when installed. Any distortion of the silicone tubing will affect the voltage index (VI) values. Store the calibrated disposable in the protective cover when not in use.**

13. Install the calibrated disposable in the pumping chamber, close the door and wait 20 seconds. Ensure distal end is vented to ambient pressure.
14. Adjust the ZERO potentiometer (R13 for channel A or R34 for channel B) to give a stable output of  $0 \pm 3.0$  mV.
15. Connect the positive (+) voltmeter lead to TP#1 (for channel A) or TP#2 (for channel B).
16. Apply and maintain  $10.0 \pm 0.1$  psi to the distal end of the calibration disposable. Wait a minimum of 15 seconds before proceeding.
17. Adjust the SPAN potentiometer (R17 for channel A or R36 for channel B) until the VTBI display reads  $2.50 \pm 0.01$ .
18. Adjust the ZERO potentiometer (R13 for channel A or R34 for channel B) until the VTBI display equals the sum of the calibrated disposable's zero pressure index  $VI_0$  plus  $2.50 \pm 0.01$ . Record the final voltage value.
19. Release the pressure, ensuring the disposable's distal end is vented to ambient pressure.
20. After  $30 \pm 5$  seconds, read the VTBI display. This reading must equal  $VI_0 \pm 0.01$ ; if it does not repeat steps 7 through 17. Record the actual voltage value.
21. Open the door.

22. Ensure the VTBI reading drops to 0.00.
23. Using your finger, gently press against the strain beam finger with sufficient pressure to fully deflect the strain beam; confirm the strain beam voltage in the VTBI display is between 4.90 and 5.15. **If the reading is not within this range, contact IMED Technical Service.**
24. Press COMPUTER CONTROL/MONITOR switch until "Powerdown Test" appears in the Operator Information display. Press START to power down the instrument.
25. Perform a Comprehensive Operational Performance Test (see Section 5.8).

## 5.8 COMPREHENSIVE OPERATIONAL PERFORMANCE TEST

The comprehensive operational performance test should be performed on any PC-2 that has been removed from service for repair or has been subjected to servicing that required the case to be opened. In the event an instrument should fail to meet specified test performance criteria, it will be necessary to troubleshoot specific areas of deficiency and perform the repairs needed to restore full operational capability prior to returning the instrument to service.

### 5.8.1 Electrical Inspection

The electrical inspection consists of the Electrical Leakage Test and Electrical Ground Test. Perform these tests in compliance with UL 544 for Patient Care Equipment and/or CSA Standard C22.2 No. 125 for Risk Class 2G Equipment. Test parameters are described in Section 2.3.2.

### 5.8.2 Qualitative Operational Performance Test

The abbreviated qualitative operational performance test will check the PC-2's keypad, audio control, displays and indicators; instrument operation in the Pump and Controller modes including those audio and visual alerts associated with normal instrument operation and the instrument power down sequence. Perform the abbreviated qualitative operational performance test in accordance with the procedures described in Section 2.3.3.2.

### 5.8.3 Quantitative Operational Performance Test

The following operational performance tests are designed to ensure the PC-2 is functioning in accordance with design specifications. Test procedures are provided to evaluate specific areas of instrument performance.

#### 5.8.3.1 Equipment Requirements

1. Universal test station: (see Fig 5-2).
  - Selector valve manifold
  - 10 mL Volumetric burette
  - Pressure gauge, 0-60 psig, accurate within 2.0% or better
  - 36" view tube (macro-bore tubing on yard stick).
2. Gas tight syringe, 100  $\mu$ L capacity.
3. Stopwatch with minimum resolution of 1 second.
4. Vented bottle or bag of Normal Saline.
5. GEMINI Non-vented administration set with 2 injection sites.
6. Waste fluid catch basin.
7. Nurse Call test lamp.
8. Maintenance Plug (**Software Release V2.13**).
9. Test Data Sheet (see figure 5-3).

#### 5.8.3.2 Test Procedures

The following test procedures are presented in a sequence that will allow the required test protocols to be accomplished accurately and in an expeditious and efficient manner. Tests are identical for channel B; upon completion of channel A testing repeat for channel B.

#### TEST SETUP

1. Spike a vented bottle or bag of Normal Saline or tap water with a GEMINI Non-vented administration set and hang on the IV solution test stand. Check the roller clamp closed.
2. Connect the distal end of the tubing set to the input side of the stopcock manifold.

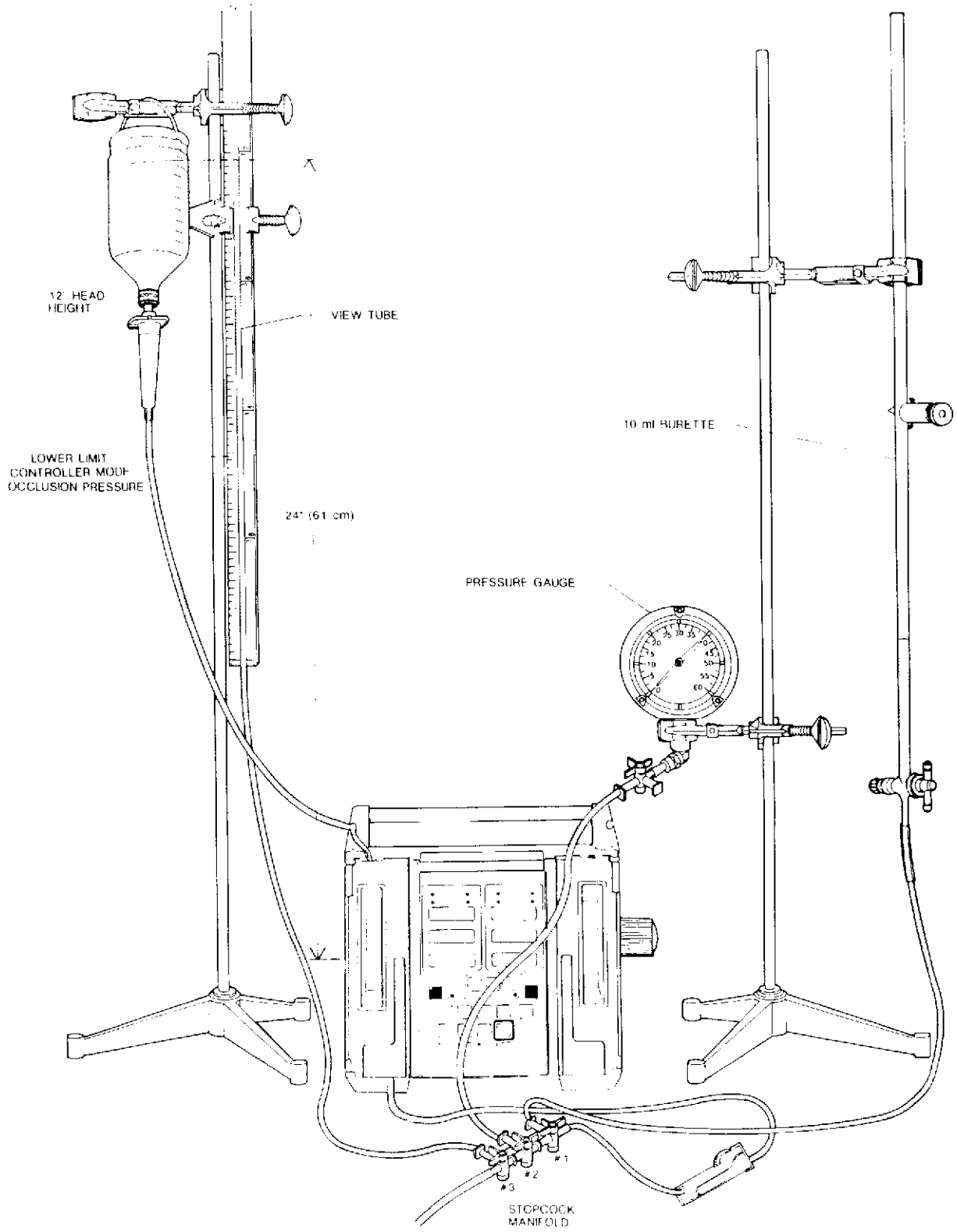

Figure 5-1. Universal Test Station Setup



3. Set the stopcocks to allow fluid to pass through the manifold to the fluid catch basin.
4. Flood the drip chamber, open the roller clamp, prime the set then close the second stopcock.
5. Adjust the height of the solution container to provide a measured head height of 24" (61 cm) i.e., 24" of vertical displacement between the strain beam and the fluid level in the container.
6. Install the tubing set in channel A of the PC-2; close and latch the access door.
7. Ensure the tubing segment between the stopcock manifold and the pressure gauge is primed.
8. Press POWER ON control and ACCESS CHANNEL A.
9. Select CONTROLLER mode, set RATE to 125 mL/hr and set VTBI to 100 mL.

#### LOW-FLOW HEIGHT TEST

1. Turn stopcock #3 to direct the pump output to the 36" view tube only. Ensure the 18" mark on the view tube is level with the fluid in the solution container.
2. Press START and observe:
  - Fluid column rises in the view tube
  - Pumping mechanism stops
  - Audio Advisory sounds
  - "LOW FLOW" advisory scrolls for 1 minute
  - After 1 minute audio alert changes to Alarm and "OCCLUDED" scrolls continuously.
3. Record the height of the fluid column in the view tube on the data sheet (reading must be between 6 and 30 inches).
4. Silence alarm, press ACCESS CHANNEL A, then press PAUSE/STOP once.

5. Turn stopcock #3 to drain the fluid column to waste; drain to the 0 graduation, then turn the stopcock to the bypass position.

#### OUTPUT PRESSURE TEST

1. Turn stopcock #1 to direct pump output to the pressure gauge.
2. Select PUMP mode.
3. Press START and observe:
  - Pumping mechanism stops
  - Audio Alarm sounds
  - "OCCLUDED-PATIENT SIDE" scrolls continuously.
4. Record pressure gauge reading on the data sheet immediately following alarm (reading must be between 8 and 12 psi).
5. Silence alarm, Press ACCESS CHANNEL A, then press PAUSE/STOP once.
6. Turn stopcock #1 to the bypass position momentarily to relieve the pressure and then turn back to the pressure gauge position.

#### PUMP PRESSURE TEST

1. Initialize instrument in the Maintenance Mode.
2. Press COMPUTER CONTROL/MONITOR switch to select "pump test".
3. Press START control twice.
4. Verify rate set to 125 mL/hr and VTBI >25 mL.
5. Press START control and allow the pump to operate for at least 30 seconds and wait until the peak pressure stabilizes.
6. Record the highest pressure reading obtained. **Resultant pressure must be  $\geq 17$  psi.**
7. Press PAUSE/STOP control twice to power down the instrument.

- Turn the Test Station stopcock #1 to the bypass position.

#### VOLUME/RATE/TIME TEST

##### Software Release V2.13

- Perform Motor Homing Test on channel to be tested (see Section 5.3.2).

##### Software Release V2.33 and Subsequent

- Home channel by opening appropriate pumping chamber access door.
- Turn stopcock #2 to direct fluid flow to the 10mL burette.
- Press START to fill the burette to the 10mL line, then press ACCESS CHANNEL A and PAUSE/STOP once.
- Press VOLUME INFUSED followed by CLEAR to reset the Volume Infused register to "0".
- Set VTBI to 5mL and verify the RATE is set to 125 ml.
- Press START and start the stopwatch simultaneously.
- When audio Advisory sounds and "INFUSION COMPLETE-KVO" scrolls, immediately stop the stopwatch and press ACCESS CHANNEL A followed by PAUSE/STOP twice.

#### NOTE

**Failure to stop the pump immediately will induce a volume accuracy error into the test.**

- Read the fluid level in the burette.
- Record the volume delivered (10 mL minus fluid level from step #7) and elapsed time on the data sheet (Volume delivered must be between 4.7 and 5.3 mL and elapsed time must be within 2:16 and 2:31 (min:sec) limits).
- Turn stopcock #2 to drain the fluid in the burette down to the 10mL line.

#### NURSE CALL INTERFACE AND MAINTENANCE MODE FUNCTIONAL TEST

#### NOTE

**The following procedures are not channel dependent and need only be performed once.**

- Remove all disposables from the instrument.
- Install the communications emulator plug in the RS-232-C Data Port.
- Install the Maintenance Plug in the Nurse Call/Maintenance Plug connector.
- Press POWER ON.
- Following the audio tone at the end of the initialization sequence, remove the Maintenance Plug and install the Nurse Call test light.
- Check the Nurse Call test light is illuminated.
- Remove the Nurse Call test light and reinstall the Maintenance Plug.
- Perform the following Maintenance Mode test in order (refer to section 5.3.2 for procedures):
  - Lamp test (vary audio volume during the test)
  - Keypad test
  - Error Log Display (clear log if 'newest' is displayed; 'failed' message indicates log has been cleared).
  - Serial Port test
  - Input Port Display
  - Powerdown test.
- Remove the Maintenance and Communication Emulator Plugs upon completion of testing.



## BATTERY CAPACITY CHECK

Battery operation with a new, fully charged battery is ≈5 hours with the instrument operating one channel at 125 mL/hr, or ≈4 hours with both channels operating at 125 mL/hr. Under conditions of normal usage (e.g., one discharge cycle/day), the battery should retain 50% of its original capacity after one year of usage.

Usage other than that described above may result in prolonged or reduced battery life (i.e., more than one discharge/day without a complete recharge may reduce battery life).

To determine battery capacity perform the following procedure:

1. Connect the AC power cord to an AC source and allow the battery to charge for 16 hours with the instrument not operating.
2. Disconnect from the AC source and operate both channels at 125 mL/hr.
3. Record the battery-operated run time to the point of activation of the "HELP BATTERY" alarm.
4. If the resultant run time is less than 2 hours, consideration should be given to replacing the battery. Follow your hospital protocol for battery replacement.



**PC-2 TEST DATA SHEET**

Instrument Serial No. \_\_\_\_\_ Software Version \_\_\_\_\_

Date \_\_\_\_\_ Technician \_\_\_\_\_

Test No.	Description	Reference	Pass/Fail
1	Electrical Leakage Test	2.3.2.1	____/____
2	Electrical Ground Test	2.3.2.2	____/____
3	Initialization	2.3.3.2	____/____
4	Keypad and Display Check	2.3.3.2	____/____
5	Controller Mode Operation	2.3.3.2	Ch A ____/____ Ch B ____/____
6	Pump Mode Operation	2.3.3.2	Ch A ____/____ Ch B ____/____
	Air-in-line	2.3.3.2	Ch A ____/____ Ch B ____/____
7	Low-Flow Height Test	5.8.3.2	Fluid Height Ch A _____ Ch B _____
8	Output Pressure Test	5.8.3.2	Pressure Ch A _____ Ch B _____
9	Pump Pressure Test	5.8.3.2	Pressure Ch A _____ Ch B _____
10	Volume/Rate/Time Test	5.8.3.2	Volume Ch A _____ Ch B _____
			Time Ch A _____ CH B _____
11	Nurse Call Test	5.8.3.2	____/____
12	Maintenance Mode Test	5.8.3.2	____/____
13	Battery Capacity Check	5.8.3.2	____/____

Figure 5-2. PC-2 Test Data Sheet

**imed**

---

THIS PAGE INTENTIONALLY LEFT BLANK