

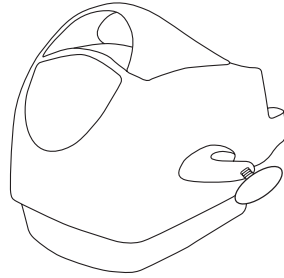

Bair Hugger*

Model 750 Warming Unit



Service Manual



Warning: Electrical Shock Hazard. There are electrically live parts within the temperature management unit when it is connected to a power source, even when the unit is in Standby mode.

For information on operating the Model 750 temperature management unit, please refer to the Model 750 Operator's Manual.

Please forward to Biomedical Engineering Department



Bair Hugger Modell 750 Temperaturmanagementgerät Service Gebrauchsanleitung

Warnung: Gefährliche elektrische Spannung. In einem an das Netz angeschlossenen Temperaturmanagement-Gerät stehen bestimmte elektrische Komponenten auch dann unter Strom, wenn sich das Gerät im Betriebsmodus Standby befindet.

Informationen zum Betrieb des Temperaturmanagement-Gerätes Modell 750 finden Sie im Betriebshandbuch für das Modell 750.

Bitte an die Abteilung für biomedizinische Technik weiterleiten.



Unité de gestion de température Bair Hugger modèle 750 Service Manuel

Avertissement : risque de secousses électriques. L'appareil de gestion de la température contient des pièces qui sont sous tension lorsqu'il est raccordé à une source d'alimentation et cela même si l'appareil est en mode d'attente.

Pour de plus amples informations sur le fonctionnement de l'appareil de gestion de la température, modèle 750, consulter le manuel de l'utilisateur du modèle 750.

A transmettre au Service d'ingénierie biomédicale



Total Temperature Management System



Bair Hugger*

Model 750 Warming Unit

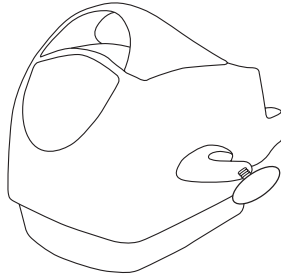

Service Manual

English 1

Deutsch 27

Français 55

Table of Contents

Introduction	1
Description of the Total Temperature Management System	1
Indications	1
Contraindications	1
Warnings	1
Cautions	2
Notices	3
Proper Use and Maintenance	3
Read Before Servicing Equipment	3
Safety Inspection	3
Overview	4
Unit Power-On-Reset	4
Operating Modes	5
Standby Mode	5
Fault Conditions	6
Over-Temperature Condition	6
Alternative Modes	7
Accessing the Alternative Modes	8
Exiting an Alternative Mode	8
Service Procedures	9
Calibrating the Operating Temperatures	9
Testing the Over-Temperature Detection System	11
Viewing the Fault Code Log	13
Clearing the Fault Code Log	13
Fault Code Table	14
Viewing the Hour Meter	15
Viewing the Operating Timer	15
Replacing the Air Filter	16
Replacing the Hose	17
Cleaning the Warming Unit	19
Technical Support and Customer Service	20
When You Call for Technical Support	20
In-Warranty Repair and Exchange	20
Returning Units for Service	21
Specifications	22
Maintenance Log	24
Definition of Symbols	25

Introduction

Description of the Total Temperature Management System

The Bair Hugger brand Total Temperature Management system consists of a Model 750 forced-air temperature management unit (with available rolling stand and sheet clip) and disposable components, including Bair Hugger forced-air blankets, Bair Paws* patient warming gowns, and the 241* blood/fluid warming set. You can use the Model 750 temperature management unit in all clinical settings including the operating room to provide patient temperature management.

This manual includes operating instructions and unit specifications for the Model 750 temperature management unit. For information about using Bair Hugger blankets, Bair Paws gowns, or the 241 blood/fluid warming set with the Model 750 temperature management unit, refer to the “Instructions for Use” included with each of these disposable components.

Indications

The Bair Hugger Temperature Management system is intended to prevent and treat hypothermia. In addition, the temperature management system can be used to provide patient thermal comfort when conditions exist that may cause patients to become too warm or too cold. The temperature management system can be used with adult and pediatric patients.

Contraindications

Do not apply heat to lower extremities during aortic cross-clamping. Thermal injury may occur if heat is applied to ischemic limbs.

Warnings

1. Do not leave patients with poor perfusion unmonitored during prolonged warming therapy sessions. Thermal injury may result.
2. The Bair Hugger temperature management unit has been designed to operate safely ONLY with Arizant Healthcare* disposable components. Use with other products may cause thermal injury. (To the full extent permitted by law, the manufacturer and/or importer declines all responsibility for thermal injury resulting from the unit being used in conjunction with non-Arizant Healthcare products.)
3.  Do not warm patients with the temperature management unit hose alone. Thermal injury may result. Always connect the hose to a Bair Hugger blanket or Bair Paws gown before providing therapy.
4. Do not place the non-perforated side of the blanket on the patient. Thermal injury may result. Always place the perforated side (that is, with small holes) towards the patient.
5. Do not continue temperature management therapy if the over-temp indicator light illuminates and the alarm sounds. Thermal injury may result. Unplug the unit, and contact a qualified service technician.

6. Do not continue 241 blood/fluid warming therapy if the over-temp indicator light illuminates and the alarm sounds. Immediately stop fluid flow, and discard the blood/fluid warming set. Unplug the temperature management unit, and contact a qualified service technician.
7. Do not use a forced-air warming device over transdermal medication. Increased drug delivery and patient injury or death may occur.
8. Do not allow the patient to lie on the warming unit hose or allow the hose to directly contact the patient's skin during patient warming; thermal injury may result.
9. Equipment not suitable for use in the presence of a flammable anesthetic mixture with air or with oxygen or nitrous oxide.
10. Resuable blankets made from woven fabric, or blankets without discrete, visible holes, can cause the safety system of this unit to fail, which may result in serious thermal injury. This warming unit has been designed to operate safety ONLY with Bair Hugger® blankets or Bair Paws gowns.

Cautions

1. Except for specific blanket models, Bair Hugger blankets are not sterile and are all intended for single patient use ONLY. Placing a sheet between the Bair Hugger blanket and the patient does not prevent contamination of this product.
2. Monitor the temperature and cutaneous response of patients who are incapable of reacting, communication and/or who are without a sense of feeling every 10-20 minutes or according to institutional protocol. Monitor the patient's vital signs regularly. Adjust air temperature or discontinue therapy when the therapeutic goal is reached or if vital sign instability occurs. Notify physician of vital sign instability immediately.
3. Do not leave pediatric patients unattended during therapy.
4. Do not initiate temperature management therapy unless the temperature management unit is safely placed on a hard surface or securely mounted. Otherwise, injury may result.
5. To prevent tipping, clamp the Model 775 temperature management unit to an IV pole at a height that provides stability. We recommend clamping the unit no higher than 44 in. (112 cm) from the floor on an IV pole with a minimum 28 in. (71 cm) diameter wheelbase. Failure to do so may result in IV pole tipping, catheter site trauma, patient injury.
6. Electrical shock hazard. Do not disassemble the temperature management unit unless you are a qualified service technician. There are electrically live parts with in the unit when it is connected to a power source, even when the unit is in Standby mode.

Notices

1. The Bair Hugger temperature management unit meets medical electronic interference requirements. If radio frequency interference with other equipment should occur, connect the unit to a different power source.
2. Federal law (USA) restricts this device to sale by or on the order of a licensed healthcare professional.
3. To reliably ground this Bair Hugger warming unit, only connect to receptacles marked “Hospital Only” or “Hospital Grade”.

Proper Use and Maintenance

Arizant Healthcare Inc. assumes no responsibility for the reliability, performance, or safety of the temperature management unit if the following events occur:

- Modifications or repairs are performed by unqualified personnel.
- The unit is used in a manner other than that described in the Operator’s or Service Manuals.
- The unit is installed in an environment that does not meet the appropriate electrical and grounding requirements.

Read Before Servicing Equipment

All repair, calibration, and servicing of the temperature management unit require the skill of a qualified, medical equipment service technician who is familiar with good practice for medical device repair. If service does not require the manufacturer’s attention, the Model 750 Service Manual provides the technical information needed to service the unit, or Arizant Healthcare Inc. will provide that information on request. Perform all repairs and maintenance in accordance with the instructions in the Service Manual.

Safety Inspection

Perform a safety inspection after making repairs to the Bair Hugger temperature management unit and before returning the unit to service. A safety inspection should include calibrating the operating temperature settings and testing the over-temperature detection function as described in this service manual as well as testing for leakage current and continuity check on safety ground.

Overview

When you connect the Model 750 temperature management unit to a grounded power source, the unit automatically performs the power-on-reset operation described below. Following the power-on-reset operation, the unit will enter the Standby mode. You can select any operating mode by pressing the appropriate button on the unit's control panel. See Figure 1.

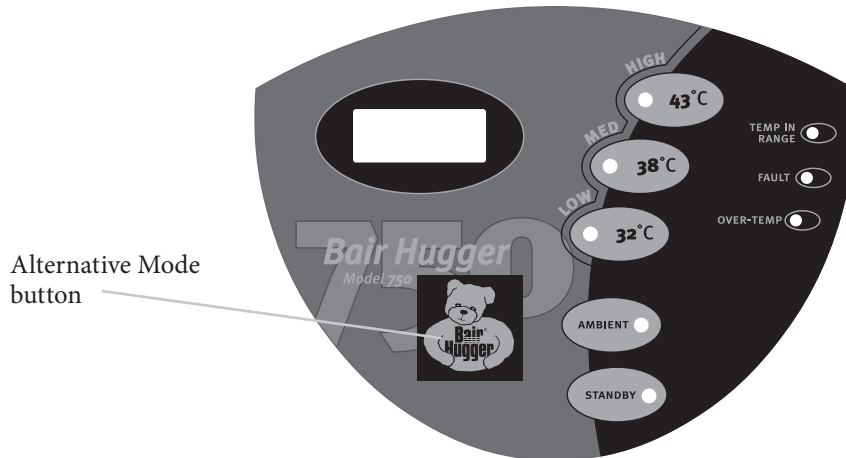

Figure 1. Control panel

Unit Power-On-Reset

The Model 750 temperature management unit performs the following power-on-reset sequence after you connect the unit to a grounded power source:

- Performs all self-test functions.
- Illuminates all indicator lights and all pixels in the alphanumeric display momentarily.
- Displays the text “BH 750” and the software revision level in the alphanumeric display.
- Produces 3 chirping sounds.
- Enters the Standby mode.

If the temperature management unit loses power for less than 1 second, the unit's software will remain in the operating mode you selected prior to the power loss. If the unit loses power for longer than 1 second, the unit's software will reset when you restore power. The unit will then enter the Standby mode.

Operating Modes

The Model 750 temperature management unit has 4 operating modes: *Ambient*, *Low*, *Medium*, *High*.

To select the *Low*, *Medium*, *High*, or *Ambient* mode, press the corresponding button. The temperature management unit will operate within the specified temperature range, shown in the table below.

Temperature Mode Temperature of Delivered Air

Low	32°C ± 1.5°C
Medium	38°C ± 1.5°C
High	43°C ± 1.5°C
Ambient	Unit will supply air that is slightly warmer than room-temperature

After you select a temperature mode, the following events occur:

- Corresponding indicator light illuminates.
- Blower operates.
- Heater activates except in *Ambient* mode.
- Temperature mode timer and hour meter activate.
- Temperature at the blanket-end of the hose appears in the alphanumeric display.
- *Temp in Range* indicator light illuminates when the temperature at the blanket end of the hose is within ±1.5°C* of the selected setting; this indicator light does not illuminate in the *Ambient* mode.

Standby Mode

To place the unit in *Standby* mode, press the **Standby** button. When in Standby mode, the following events occur:

- *Standby* indicator light illuminates.
- Blower and heater turn off.
- Alphanumeric display deactivates.
- Temperature mode timer pauses.
- Alarm and fault detection functions remain active.

* Within ±3°C in units with < Rev L Software. The Rev version appears in the display window upon connection to a power source.

Fault Conditions

The Model 750 temperature management unit's software recognizes several nonhazardous fault conditions including:

- Sensor failures
- Heater failures
- Computer failure
- Software failure
- Keypad failure
- Power supply failure
- Blower motor failure
- Forced over-temperature test failure

When a fault condition exists, the following events occur:

- Fault indicator light flashes.
- Audible alarm sounds.
- Fault code appears in the alphanumeric display.
- Up to 5* fault codes are stored in memory.

When the audible alarm sounds, press any button on the keypad to temporarily silence it. The temperature management unit must be unplugged before it can be restarted. See *Viewing the Fault Code Log* on page 13 and the *Fault Code Table* on page 14 for more information about specific fault codes.

Over-Temperature Condition

When an overtemperature condition exists, the following events occur:

- Over-temp indicator light flashes.
- Audible alarm sounds.
- Blower and heater turn off.
- Fault code appears in the alphanumeric display (see page 14).

When the audible alarm sounds, press any button on the keypad to temporarily silence it. The temperature management unit must be unplugged before it can be restarted.

* Up to 3 fault codes in units with < Rev L software. The Rev version appears in the display window upon connection to a power source.

Alternative Modes

The Model 750 temperature management unit has 5 alternative modes that allow access to the service and calibration utilities of the unit.

Alternative Modes

AltMode0	<i>Hour meter</i>
AltMode1	<i>Calibration</i>
AltMode2	<i>Fault code log</i>
AltMode3	<i>System information</i>
AltMode4	<i>Over-temperature detection test</i>

The *Hour Meter* mode displays the cumulative amount of operating time (in *Ambient*, *Low*, *Medium*, and *High* modes) the temperature management unit has accrued since the initialization of EEPROM. The time is displayed in whole hours only.

The *Calibration* mode allows a technician to check and adjust the nozzle temperature. This should be done as part of routine maintenance and always after servicing the temperature management unit or replacing the hose. The nozzle temperature can be altered a maximum of $\pm 3.0^{\circ}\text{C}$ by adjusting the calibration offset value. In the *Calibration* mode, the temperature management unit operates in the *Ambient* temperature mode, and the alphanumeric display shows the current nozzle temperature and calibration offset with 0.1°C precision.

The *Fault Code Log* mode sequentially displays the last 5* fault codes stored in system memory. Please refer to the Fault Code Table on page 14 for more information about a particular fault code.

The *System Information* mode allows the technician to view important system information including the firmware, system identification, serial port baud rate, 5V power supply status, and the control board serial number.

The *Over-temperature Detection Test* mode allows the user to test the operation of the independent over-temperature shutdown system.

* The last 3 fault codes in units with < Rev L software. The Rev version appears in the display window upon connection to a power source.

Accessing the Alternative Modes

To access the alternative modes, you must press the **Alternative Mode** button that is located on the front panel of the temperature management unit but is unlabeled. Press the “Bair Hugger” text on the bear logo when the instructions direct you to press the alternative mode button.

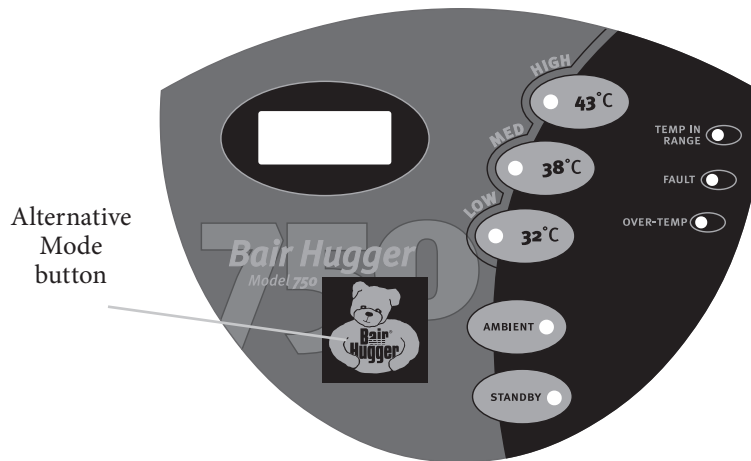

Figure 2. Control panel

To enter one of the alternative modes, press the alternative mode button in combination with one of the operating mode buttons, also located on the front panel. The chart on the following page indicates which keys must be pressed to enter each of the 5 alternative modes. When the correct combination of keys is pressed, the display reads “Hold for AltModeX,” where “X” represents the selected alternative mode from the list above.

Exiting an Alternative Mode

Exit the alternative modes by pressing the alternative mode button or by waiting for 60 seconds. You will need to access the alternative modes for several of the service procedures described in this manual.

Service Procedures

CAUTION

Do not use automatic testers for service procedures; always test the temperature management unit manually. Failure to do so may cause Fault Code 053.

Calibrating the Operating Temperatures

CAUTION

Perform all temperature testing of the temperature management unit with an Arizant Healthcare Model 22110 Temperature Test Unit.

Arizant Healthcare Inc. assumes no responsibility for the reliability, safety, or performance of the Total Temperature Management system if temperature tests or adjustments are made in any manner other than those described here. Improper measurement or adjustment of the temperature management unit's normal operating temperature could result in patient exposure to temperatures outside of the indicated range and may lead to patient injury.

Service frequency

Every 6 months or 500 hours of use, or whenever service is performed.

Tools/equipment

Model 22110 Temperature Test Unit

NOTES:

- The Model 22110 Temperature Test Unit simulates the operating characteristics of Bair Hugger blankets when used with Bair Hugger temperature management units.
- When using the Model 22110 Test Unit, take temperature readings using a calibrated thermometer that can accept a male, subminiature connector and read a "K" style thermocouple (e.g., a Fluke Model 52 K/J Thermometer). If the test unit's connector does not fit your thermometer, remove the connector from the test unit and attach a connector that fits your meter. Be certain to observe polarity.

Method

NOTE: If the temperature management unit has been stored at a temperature lower than 20°C, allow it to reach ambient temperature before beginning the calibration procedure.

4. Attach the Model 22110 temperature test device to the end of the temperature management unit hose.
5. Connect the temperature management unit to a grounded power source. The unit performs a self-test and automatically proceeds to *Standby* mode.
6. Press the **Ambient** button to place the unit in *Ambient* mode. Allow the unit to run in Ambient mode for at least ten minutes to equalize the temperature of the unit's internal components.
7. Press the **Alternative Mode** button (see Figure 2 on page 8) and the **Ambient** button simultaneously for 3 seconds. The temperature management unit is now in *Calibration* mode. In this mode, the temperature management unit performs the following tasks:
 - *Low* and *Med* indicator lights flash.
 - Blower activates.
 - Heater elements deactivate.
 - The text "TMP" and the temperature in °C (0.1°C resolution) at the end of the hose appear in the alphanumeric display.
 - The text "OS" and the current calibration offset value (0.1°C resolution) appear in the alphanumeric display.
8. Compare the temperature shown on the alphanumeric display and the temperature on the independent, temperature calibration device.
 - If the temperatures match, press the **Alternative Mode** button to return the temperature management unit to *Standby* mode.
 - If the temperatures do not match, adjust the temperature management unit's displayed temperature:
 - a. Press the **Low** button to decrease the temperature or the **Med** button to increase the temperature by 0.1°C. You can adjust the temperature of the temperature management unit a maximum of ±3°C.
 - b. Continue to press the **Low** or **Med** button(s) until the temperature in the alphanumeric display matches the temperature on the calibration device.
 - c. Press the **Alternative Mode** button to store the calibration offset value and return the temperature management unit to *Standby* mode.

NOTE: If it is necessary to enter an offset value greater than ±3°C, there may be a defect in the set point sensor. Remove unit from service until a new hose assembly can be substituted.

Testing the Over-Temperature Detection System

WARNING

Do not perform the over-temperature detection system test while the temperature management unit is being used for temperature management therapy. Thermal injury may result.

CAUTION

Connect each warming unit being tested to a separate power source.

Service frequency

Every 6 months or 500 hours of use, or whenever service is performed.

Tools/equipment

Model 22110 Temperature Test Unit

Method

NOTE: If the temperature management unit has been stored at a temperature lower than 20°C, allow it to reach ambient temperature before beginning the test.

1. Connect the temperature management unit to a grounded power source. The unit performs a self-test and automatically proceeds to Standby mode
2. Connect the temperature test kit to the hose of the temperature management unit.
3. Press the **Ambient** button and allow the temperature management unit to run for 5 minutes.
4. Press the **Alternative Mode** button (See Figure 2 on page 8) and the **High** button simultaneously for 3 seconds. The temperature management unit is now in a *Forced Over-temperature* mode. In this mode, the temperature management unit performs the following tasks:
 - Blower activates.
 - Heater elements continuously operate at full power.
 - *High* indicator light flashes.
 - Over-temperature timer activates.
 - “OT Test” flashes in the alphanumeric display.

5. Wait for the temperature management unit to perform the over-temperature test. When the test is complete, the temperature management unit performs the following tasks:
 - Heater elements deactivate.
 - Blower continues to operate. (NOTE: The blower turns off if an over-temperature condition occurs during normal use.)
6. View the alphanumeric display to determine test outcome:
 - a. PASS–The unit detected an over-temperature condition within 150* seconds. An alarm sounds for 2 short beeps. The text “PASS” flashes in the alphanumeric display, followed by these messages:
 1. OT Test OT Test
 PASS-Prx OR PASS-Dst
 2. TestTime
 XX Secs
 3. Unplug
 To Reset
 - b. FAIL–Unit did **not** detect an over-temperature condition within 150* seconds (time-out failure). An alarm sounds and the *Fault* indicator light flashes. The text “FAIL” flashes in the alphanumeric display, followed by these messages:
 1. OT Test
 FAIL
 2. TestTime
 150* Secs
 3. Unplug
 To Reset
7. Record the maximum temperature displayed by the test kit. (Use maintenance log on page 24.) If the temperature is outside of the $53\pm 3^{\circ}\text{C}$ specification, contact Arizant Healthcare technical service for further instructions.
8. Unplug the temperature management unit to reset it.

*Within 90 seconds in units with < Rev L software. The Rev version appears in the display window upon connection to a power source.

Viewing the Fault Code Log

Service frequency

As often as necessary.

Tools/equipment

None required.

Method

1. If your temperature management unit is already ON, you can access the fault code log from any operating mode. Otherwise, connect the temperature management unit to a grounded power source. The unit performs a self-test and automatically proceeds to *Standby* mode. Then select any operating mode.
2. Press the **Alternative Mode** button (see Figure 2 on page 8) and the **Low** button simultaneously for 3 seconds. The temperature management unit is now in *Fault Code Log* mode. In this mode, the temperature management unit performs the following tasks:
 - a. Continues to operate in current operating mode.
 - b. *Low* and *Med* indicator light flashes.
 - c. Text “FC(n) XX” appears in the alphanumeric display. “FC” is an abbreviation for the phrase “fault code,” “n” represents the numerical order of the fault code in the log, and “XX” represents the code for the fault condition. See page 14 for a list of fault codes and their meanings.
 - d. The time of each fault appears below “FC(n) XX” in the alphanumeric display.
3. Press either the **Low** or **Med** button to view the next fault code in the log. The temperature management unit stores a maximum of 5* fault codes in non volatile memory.
4. Press the **Alternative Mode** button to return the temperature management unit to its previous operating mode.

Clearing the Fault Code Log

NOTE: This option is available only with software Rev M or greater.

Put the unit in Fault Code Mode by pressing the Alternative Mode button and the Low button simultaneously for 3 seconds; then, press the High button.

*Stores a maximum of 3 fault codes in units with < Rev L software. The Rev version appears in the display window upon connection to a power source.

Fault Code Table

The software will detect and report the following conditions by displaying the corresponding fault code:

<u>Fault Condition</u>	<u>Fault Code</u>	
Internal sensor 1 over-temperature condition	01	
Hose end sensor 2 over-temperature condition	02	
Hose end sensor 3 over-temperature condition	03	
Internal sensor 1 shorted	04	
Hose end sensor 2 shorted	05	
Hose end sensor 3 shorted	06	
Hose end sensor 2 open	07	
Low wattage heater failure	08	
Medium wattage heater failure	09	
High wattage heater failure	10	
A/D converter timeout	11	
A/D startup check failed	12	
(Reserved Fault Code)	13	
Error in execution loop	14	
Timeout on alphanumeric display busy flag clearing	15	
RAM corruption in duplicate RAM locations	16	
Error in executing a depressed key	17	
Stuck key during startup	50	
EEPROM is at max # write cycles	51	
Non-0 EEPROM byte detected after zeroing	52	
EEPROM checksum failure on copy # 1	53	(see page 9)
EEPROM compare failure copy #1 to copy #2	54	
EEPROM compare failure copy #1 to RAM	55	
EEPROM write cycle time out	56	
SPI byte transfer time out	57	
EEPROM write error when entering standby	59	
Real time clock failure	60	
5 V power supply in excess of 5.333 V	100	
5 V power supply under 4.667 V	101	
Startup test EEPROM error	102	
Startup test RAM error	103	

Viewing the Hour Meter

Service frequency

As often as necessary.

Tools/equipment

None required.

Method

1. If your unit is already ON, you can begin the test from any operating mode. Otherwise, connect the temperature management unit to a grounded power source. The unit performs a self-test and automatically proceeds to *Standby* mode. Then select any operating mode.
2. Press the **Alternative Mode** button for 3 seconds. (See Figure 2 on page 8.) The temperature management unit is now in *Hour Meter Display* mode. In this mode, the temperature management unit performs the following tasks:
 - a. Continues to operate in current operating mode.
 - b. “Hours” appears in the alphanumeric display.
 - c. Cumulative hours of temperature management unit operation appear in the alphanumeric display.
3. Wait 60 seconds or press the **Alternative Mode** button to return the temperature management unit to its previous operating mode.

Viewing the Operating Timer

To view the amount of time the temperature management unit has been operating in the current temperature mode, press and hold the current temperature mode button for at least 3 seconds. The time is displayed in HH:MM:SS format.

Replacing the Air Filter

Service frequency

Every 6 months or 500 hours of use.

Tools/equipment

- Replacement air filter
- #2 Phillips screwdriver

WARNING

Do not attempt to clean the air filter as it may contain hazardous microorganisms. Discard the filter in a manner consistent with institutional protocol for biohazardous material.

Method

1. Disconnect the temperature management unit from the grounded power source.
2. Turn the temperature management unit upside down.
3. Remove the 2 screws located in the louvered filter cover.
4. Lift the filter cover off the temperature management unit.
5. Remove the air filter and discard it.
6. Place the new filter in the filter compartment with the gasket toward the filter ledge.
7. Replace the filter cover with the louvers facing the back of the temperature management unit.
8. Replace the 2 screws in the filter cover.

Replacing the Hose

Service frequency

As needed.

Tools/equipment

- Replacement hose
- Phillips screwdriver
- Slotted screwdriver (for grommet replacement option)
- Needle-nose pliers
- Screw grommets (included in kit)

Method

DETACHING HOSE

1. Disconnect the temperature management unit from the power source before replacing hose.
2. Unscrew the hose collar.
3. If present, use the Phillips screwdriver to remove the 2 screws that attach the hose to the unit.
4. Slide the hose out of the temperature management unit. The hose will still be attached to the unit by a cable.
5. Using the needle-nose pliers, carefully detach the cable connector from the header plug located inside the hose connector. See Figure 3.

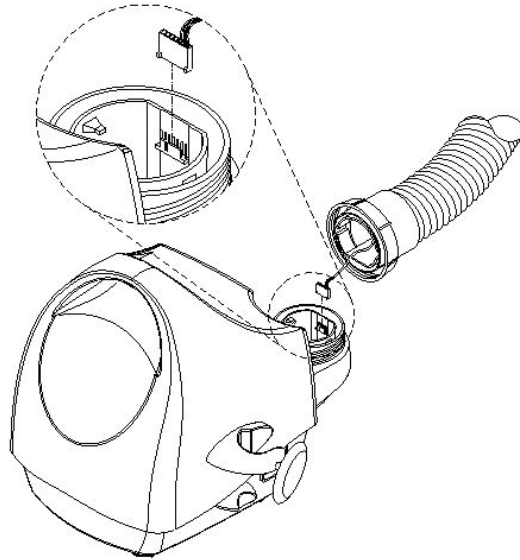

Figure 3. Hose replacement

REATTACHING HOSE

1. Attach the cable connector of the new hose to the header plug, making sure that the protrusions on the connector align with the corresponding slots on the header.
2. Align the flat section of the hose end with the corresponding flat part of the unit's hose connector and slide the replacement hose into the temperature management unit.
3. Screw the hose collar back into place.
4. Reconnect the temperature management unit to a grounded power source.
5. Calibrate operating temperature settings.
6. Perform over-temperature detection system test.

Cleaning the Warming Unit

Service frequency

As needed.

Tools/equipment

- Soft cloth lightly dampened with water
- Mild detergent or antimicrobial spray
- Dry soft cloth

WARNING

- Do not immerse the cabinet or hose while cleaning. Moisture will damage the components, and thermal injury may result.

PRECAUTIONS

- Do not use a dripping wet cloth to clean the cabinet. Moisture may seep into the electrical contacts and damage the components.
- Do not use alcohol or other solvents to clean the cabinet. Solvents may damage the labels and other plastic parts.

Method

1. Disconnect the temperature management unit from the power source before cleaning.
2. Wipe the cabinet and the outside of the hose with a damp, soft cloth and a mild detergent or antimicrobial spray.
3. Dry with a separate soft cloth.

Technical Support and Customer Service

USA, Worldwide

TEL:	FAX:
800-733-7775	800-775-0002
952-947-1200	952-947-1400

Within Europe

TEL:	FAX:
+49-4154-9934-0	+49-4154-9934-20
0800-100-1324 (Toll-free in Germany)	0800-100-1324 (Toll-free in Germany)
0800-877-077 (Toll-free in Switzerland)	0800-877-088 (Toll-free in Switzerland)

When You Call for Technical Support

We will need to know the serial number of your Bair Hugger temperature management unit when you call us. The serial number label is located on the back or side of the unit.

In-Warranty Repair and Exchange

USA

Call Arizant Healthcare customer service if your Model 750 temperature management unit requires factory service. A customer service representative will give you a Return Authorization (RA) number. Please use this RA number on all correspondence concerning your temperature management unit. Your customer service representative will also send a shipping carton to you at no charge, if needed. Call your local supplier or sales representative to inquire about borrowing a temperature management unit while we service your unit.

WORLDWIDE

Contact your local distributor concerning in-warranty repair and exchange.

Returning Units for Service

Tools/equipment

- Arizant Healthcare service carton
- Tape dispenser
- Shipping label
- Marking pen

Method

1. Call Technical Support (see page 20 for contact information) to get a Return Authorization (RA) number and a service carton.
2. Remove the top foam piece. If the plastic liner is available, use it to enclose the the temperature management unit.
3. Lower the temperature management unit carefully into the carton.
4. Place the unit hose on the temperature management unit. See Figure 4.
5. Replace the top foam piece. Observe proper orientation.
6. Seal the carton with tape.
7. Apply the shipping label addressed to Arizant Healthcare Inc.
8. Write the RA number on the outside of the carton.
9. Ship to Arizant Healthcare.



Figure 4. Packing configuration (View: Looking down into box.)

Specifications

Physical Characteristics

DIMENSIONS	12" high x 13.5" deep x 10" wide 30 cm high x 34 cm deep x 25 cm wide
WEIGHT	15.5 lb (7kg)
RELATIVE NOISE LEVEL	55 dBA
HOSE	Flexible, compatible with the Bair Hugger brand 241 blood/fluid warming system.
FILTRATION SYSTEM	0.2 μ m air filter
RECOMMENDED FILTER CHANGE	Every 6 months or 500 hours of use.
MOUNTING	Can be clamped to an IV pole, placed on a hard surface, or mounted to the rolling stand accessory.

Temperature Characteristics

RECOMMENDED OPERATING ENVIRONMENT	15°C-25°C
TEMPERATURE CONTROL	Electronically controlled.
HEAT GENERATED	1644 BTU/hr (average), 482 W (average)
OPERATING TEMPERATURES	Average temperatures at the end of the hose: HIGH: 43° ± 1.5°C 109.4° ± 2.7°F MED: 38° ± 1.5°C 100.4° ± 2.7°F LOW: 32° ± 1.5°C 89.6° ± 2.7°F

Safety System

THERMOSTAT	Independent electronic circuit; thermal cutoff shuts the heater OFF to ensure hose end air remains below 56°C (53°C ± 3°C typical); back-up over-temperature detection at hose inlet.
ALARM SYSTEM	Over-temperature ($\leq 56^\circ\text{C}$, $53^\circ\text{C} \pm 3^\circ\text{C}$ typical): red Over-temp indicator light flashes, alarm sounds, heater and blower shut down, operating indicator lights turn OFF, control panel becomes unresponsive. Fault: amber Fault indicator light flashes, alarm sounds, up to 5* fault codes stored in nonvolatile RAM.
OVERCURRENT PROTECTION	Dual input fused lines.

* 3 fault codes in units with < Rev L software.

















Electrical Characteristics

HEATING ELEMENT	1400 W Resistive
LEAKAGE CURRENT	Meets UL 60601-1 and IEC 60601-1 requirements.
BLOWER MOTOR	Operating speed: approximately 4,000 rpm Airflow: up to 48 cfm or 23 L/s
POWER CONSUMPTION	Peak: 1550 W Average: 800 W
POWER CORD	15 ft., SJT, 3 cond., 13 A 15 ft., SJT, 3 cond., 15 A 4.6 m, HAR, 3 cond., 10 A
DEVICE RATINGS	110-120 VAC, 50/60 Hz, 11.7 A, or 220-240 VAC, 50/60 Hz, 7.2 A, or 100 VAC, 50/60 Hz, 15 A
FUSES	12 A (110 - 120 VAC) 8 A (220 - 240 VAC) 15 A (100 VAC)
CERTIFICATIONS	IEC 60601-1: UL 60601-1; CAN/CSA-C22.2, No. 601.1; EN 60601-1-2; EN 55011; ASTM F2196-02.
CLASSIFICATIONS	Classified under EN 60601-1 Guidelines (and other national versions of the Guidelines) as Class II, Type BF, Ordinary equipment, Continuous operation. Not suitable for use in the presence of flammable anesthetic mixtures with air or with oxygen or nitrous oxide. Classified by Underwriters Laboratories Inc. with respect to electric shock, fire, and mechanical hazards only, in accordance with UL 60601-1, ASTM F2196-02, and Canadian/CSA C22.2, No. 601.1. Classified under the Medical Device Directive as a Class IIb device.
DIAGNOSTICS	A qualified service technician can perform over-temperature detection system testing, temperature output testing, operating temperature calibration, and fault code troubleshooting.



Definition of Symbols

The following symbols may appear on the product's labeling or exterior packaging.

	ON/STANDBY
	ON (used on isolation switch)
	OFF (used on isolation switch)
	ON/OFF push button switch
	Temperature control
	Equipotentiality plug (ground)
	Fuse
	Caution Attention, consult appropriate documents
	Warning
	Nonexplosion proof
	Dangerous voltage
	Type BF equipment (patient applied)
	Voltage, alternating current (AC)
	Special Refuse, discard separately
	Protective earth ground
	No free hosing

