

spirolab *III*

User Manual

User Manual Rev 1.6

Issued on	23/04/2007
Approved on	23/04/2007



Thank you for choosing a product from MIR Medical International Research

The original packaging contains one of the following spirometers, complete with its standard accessories:

PRODUCT without oximetry option	CODE	PRODUCT with oximetry option	CODE
Spirolab <i>III</i> bag	672685	spirolab <i>III</i> bag	672685
Spirolab <i>III</i> device	910551	spirolab <i>III</i> device plus oxy	910551
MiniFlowmeter sensor	910590	MiniFlowmeter sensor	910590
Spirolab <i>III</i> User Manual	980067	spirolab <i>III</i> User Manual	980067
USB connection cable	532365	USB connection cable	532365
MiniFlowmeter to Spirolab <i>III</i> cable	532370	MiniFlowmeter to Spirolab <i>III</i> cable	532370
1 power supply (220V)	920665	1 power supply (220V)	920665
CD winspiroPRO	920100	CD winspiroPRO	920100
1 Roll of thermal paper	910350	1 Roll of thermal paper	910350
1 nose clip	910320	1 nose clip	910320
2 paper mouthpieces	910300	2 paper mouthpieces	910300
2 disposable turbine sensors	910001	2 disposable turbine sensors	910001
1 reusable turbine sensor	910000	1 reusable turbine sensor	910000
1 spare fuse (internal) 2A	270464	1 spare fuse (internal) 2A	270464
1 spare fuse (internal) 4A	270468	1 spare fuse (internal) 4A	270468
		1 oximeter sensor	919010

OPTION	CODE	OPTION	CODE
Serial/parallel printer converter	910110	Serial/parallel printer converter	910110
Connection cable RS 232, 9 pin for PC	671492	wrap finger sensor for oximetry over a long period	919001
		Connection cable RS232, 9 pin for PC	671492

Before using your spirometer ...

Please read this manual carefully, plus the labels and all of the information supplied together with the product.

WARNING 

 **Note that this symbol means: read the instructions carefully before use.**

Set up the device (date, time, language, predicted values, etc.) to your requirements as described under Configuration Menu in this Manual.

Keep the original packaging!

In the event that your spirometer has a problem, always use the original packaging to return it to your local distributor or to the manufacturer.

MIR has a policy of continuous product development and improvement, and the manufacturer therefore reserves the right to modify and to update the information contained in this User's Manual as required. Any suggestions and or comments regarding this product should be sent via email to: mir@spirometry.com. Thank you.

MIR accepts no responsibility for any loss or damage caused by the use of the device due to the use of this Manual and/or due to an incorrect use of the product. Note that due to printing limitations the screenshots shown in this manual may differ from the display of the machine and/or from the keyboard graphics. Copying this manual in whole or in part is strictly forbidden.

IMPORTANT NOTE

If the instrument is returned for repair it **must** be accompanied by a clear and detailed explanation of the defect or problem found.

- the unit must be returned in its original packaging;
- transport costs must be prepaid.

Manufacturer's address:

MIR srl: Via Del Maggiolino, 125

00155 Roma, Italy

Tel ++ 39 0622754777

Fax ++ 39 0622754785 e-mail: mir@spirometry.com

INDEX

INTRODUCTION.....	6
1 GENERAL INFORMATION.....	6
1.1 Intended use.....	6
1.1.1 User Category.....	6
1.1.2 Ability and experience required.....	6
1.1.3 Operating environment.....	7
1.1.4 Who can or must make the installation.....	7
1.1.5 Subject effect on the use of the device.....	7
1.1.6 Limitations of use - Contraindications.....	7
1.2 Important safety warnings.....	8
1.2.1 Danger of cross-contamination.....	10
1.2.2 Turbine.....	11
1.2.3 Mouthpiece.....	11
1.2.4 Oximetry sensor.....	12
1.3 problems and unforeseen errors.....	13
1.4 LABELS AND SYMBOLS.....	14
1.5 techical features of the spirometer.....	16
1.6 technical specifications.....	17
1.6.1 Features of the spirometer.....	17
1.6.2 Features of the oximeter.....	18
2 PRODUCT DESCRIPTION.....	22
2.1 ILLUSTRATION OF Spirolab III.....	24
2.2 keyboard.....	24
2.3 Charging the battery.....	25
2.4 Switching on the spirometer.....	26
2.5 Settings.....	26
2.5.1 Contrast settings.....	27
2.5.2 Loading the thermal paper.....	27
2.5.3 Connecting the flow sensor.....	28
2.5.4 Switching off the spirometer.....	28
2.5.5 Initial settings.....	29
2.5.6 Functioning of the spirometer.....	35
2.5.7 New subject data entry.....	37
2.5.8 Modify subject data.....	38
2.6 Spirometry: fvc, vc/ivc, mvv.....	38
2.6.1 Spirometry testing.....	39
2.6.2 Spirometry post - drug.....	40
2.7 Test quality control - spirometry.....	42
2.8 Repeatability of the fvc test.....	43
2.9 Method of measurement and interpretation.....	43
2.10 Oximetry testing.....	44
2.10.1 Spot oximetry.....	47
2.10.2 Sleep Oximetry.....	48
2.10.3 Exsercise oximetry.....	49
2.10.4 Spot oximetry (MEMORIZED LIKE OXYTEST).....	50
2.11 File organization.....	50

2.12	Search and read tests in memory.....	51
2.12.1	Subject List by last name:.....	51
2.12.2	Subject List by ID code.....	52
2.12.3	Memory List.....	52
2.13	View and print results.....	52
3	DATA TRANSMISSION.....	54
3.1	Data Transmission via Bluetooth to a cell phone.....	54
3.1.1	Preliminary operations.....	54
3.1.2	Setting the Phone Number.....	54
3.1.3	Data Transmission through Bluetooth.....	54
3.1.4	Data Transmission via Bluetooth for printing.....	55
3.2	Connection to a pc.....	55
3.2.1	Connection to a PC through a USB port.....	56
3.2.2	Connection to PC through RS 232 port.....	56
3.3	Upgrade internal software.....	56
4	MAINTENANCE AND CLEANING.....	56
4.1	Cleaning the device.....	57
4.2	Cleaning the reusable turbine.....	57
4.3	Cleaning and disinfection of the oximetry sensor.....	59
5	PROBLEMS/CAUSES AND SOLUTIONS.....	60
5	LIMITED WARRANTY CONDITIONS.....	62
ANNEXES.....		64
	Declaration of conformity.....	64
	Example of oximetry test report.....	65
	Information for correct use in an electromagnetic environment.....	66
N		

INTRODUCTION

The spirometers series MIR009 are sold with the **spiroLab III** trademark.

spiroLab III is available with two different displays:

- Colour LCD display
- B/W LCD display

Unless otherwise specified, from this point onwards the term **spiroLab III** is used to refer to both models.

1 GENERAL INFORMATION

1.1 INTENDED USE

SpiroLab III spirometer and pulse oximeter is intended to be used by either a physician, respiratory therapist or technician.

The device is intended to test lung function and can make:

- spirometry testing in people of all ages, excluding infants and neonates
- oximetry testing in people of all ages.

It can be used in any setting.

1.1.1 User Category

spiroLab III, spirometer + pulse oximeter calculates a series of parameters relating to human respiratory function.

1.1.2 Ability and experience required

The correct use of the device, the interpretation of the results and the maintenance of the device, with particular WARNING on cleaning operations (cross-contamination risk), all require qualified personnel.

WARNING 

MIR cannot be held responsible for any damage caused by the user of the device failing to follow the instructions and warnings contained in this manual. If the user of spiroLab III is a person considered to be cognitively impaired, then the operation of the device must be made under the supervision and responsibility of whoever is legally charged with the supervision of this person.

The spirolab III when used as a pulse oximeter is intended for spot-checking, overnight sleep screening and/or continuous monitoring when attended by a trained healthcare professional.

1.1.3 Operating environment

The device has been envisaged for use in a doctor's office or in a hospital setting. The information necessary for the proper use of the device in surrounding electromagnetic environments (as required by EN 60601-1-2) is contained in the Annex. The device is not intended for use in an operating theatre nor in the presence of inflammable liquids or detergents, nor in the presence of inflammable anaesthetic gases (oxygen or nitrogen). The device is not designed to be used in direct air currents (e.g. wind), sources of heat or cold, direct sun rays or other sources of light or energy, dust, sand or any other chemical substances.

The user and/or the doctor are responsible for ensuring that the device is stored and used in appropriate environmental conditions; in this regard reference is made to the specifics described in paragraph 1.5 below.

WARNING 

If the device is exposed to unsuitable environmental conditions, this could cause the device to malfunction and to give incorrect results.

1.1.4 Who can or must make the installation

The device requires installation by qualified personnel. The user shall normally configure the device accordingly.

1.1.5 Subject effect on the use of the device

A spirometry test should only be carried out when the subject is at rest and in good health, and thus in a suitable condition for the test. A spirometry test requires the collaboration of the subject, since the subject must make a complete forced expiration, in order to have a meaningful test result.

1.1.6 Limitations of use - Contraindications

An analysis of the results of a spirometry test is not by itself sufficient to make a correct diagnosis of the subject's clinical condition. Test comments, a test interpretation and suggested courses of treatment must be given by a doctor.

Any symptoms that the subject has at the time must be carefully considered before a spirometry test is made. The user is responsible to assess both the mental and the physical capacity of the subject to make a correct test and the user must also assess the degree of collaboration for each test carried out.

A correct spirometry test requires the complete collaboration of the subject. The results depend on the person's capability to inspire and to expire all air completely and as fast as

possible. If these fundamental conditions are not respected then the results obtained during spirometry testing will not be accurate, and therefore the test results are "not acceptable". The acceptability of a test is the responsibility of the user. Special WARNING should be given to testing elderly subjects, children and handicapped people. The device should never be used when it is possible or probable that the validity of the results may be compromised due to any such external factors.

WARNING 

The instrument must be used as described in the User's Manual with particular WARNING to the paragraph on Intended Use utilizing only original spare parts and accessories as specified by the manufacturer may be used. Use of non original parts such as the turbine sensor or other accessories may cause errors in measurement and/or compromise the correct functioning of the device. Any use of the device which differs from the original is to be considered improper and therefore dangerous.

The spirolab III when used as a pulse oximeter has limited alarms, therefore the device requires frequent display observation of SpO2 and pulse rate.

1.2 IMPORTANT SAFETY WARNINGS

spirolab III has been examined by an independent laboratory which has certified the conformity of the device to the European Safety Standards **EN 601-1** and guarantees the EMC Requirements within the limits laid down in the European Standard **EN 60601-1-2** *spirolab III* is constantly controlled during its production, therefore the product confirms to the established security levels and quality standards laid down by the Council Directive 93/42/CEE for medical devices.

After removing the device from its packaging, check that there is no visible damage. In case of damage do not use the device and return it to the manufacturer for repair.

WARNING 

The safety and the correct performance of the device can only be assured if the user of the device respects all of the relevant safety rules and regulations. The manufacturer cannot be held responsible for damage caused by the failure of the user to follow these instructions correctly. In the event of any incident or accident of any kind resulting from the use of the device, the user is required to inform the manufacturer without delay, this procedure is laid down in article.9 of the European Regulations No. 46/1997, which confirmed the CE Directive No. 93/42

Safety and correct functioning of the device are guaranteed only if the safety standards in force are respected.

Keep the instructions for use together with the warranty conditions for any future reference or in case the device presents technical problems.

The manufacturer cannot be held responsible for damage caused by the failure of the user to follow these instructions correctly, misuse of the device whether that misuse is improper, incorrect and/or unreasonable, or when the device is connected to an electrical outlet which does not conform to the safety regulations in force.

The device and its accessories must be controlled before each and every use, so that any malfunction and/or damage caused during transport and/or storage may be detected.

Keep the device away from hot and/or cold sources.

The thermal paper used for printing is highly inflammable. Keep away from open flames.

High-frequency emissions that are outside the limits expressed by the EN60601-1-2 may interfere with the correct functioning of the device. High frequency emissions coming from other electrical or electronic devices can interfere with the functioning of the device. For this reason certain minimum clearances (a few meters), should be observed when high-frequency appliances such as TV, radio, cellular phones, etc and other electronic units are operated in the same room.

When connecting the *spirolab III* to any other devices (PC, printer, modem etc.), the user must guarantee that the required security level for subjects and/or users in the same room are not in any way endangered by the connection.

If the PC and/or the printer connected to *spirobank II* come into contact with the area containing patient data, ref. directive EN 60601-1-1, it is necessary that they conform to the directive EN 60601-1.

The instrument may give inaccurate readings if operated in the presence of strong electromagnetic sources, such as electrosurgical equipment, or in the presence of computed tomography (CT) equipment.

If the device is not functioning properly, switch it off and consult the instruction manual. After correctly following all the instructions, if the device does not function correctly, call the manufacturer or an authorized service centre for assistance.

For any repairs call only certified service centres that are authorized by the manufacturer, or directly call the manufacturer.

Do not open or tamper with the device.

Always use and demand only original spare parts.

For the recycling of the *SpirolabIII*, the accessories, plastic consumable materials (mouthpieces), and removable parts (for example the disposable turbine), use only the appropriate containers or return all such parts to the dealer or to a recycling centre. All applicable local regulations must be followed.

If any of these rules are not followed then MIR will decline all responsibility for any direct or indirect damages, however caused.

Use of non original parts such as the turbine flow sensor and other accessories may cause errors in measurement and/or compromise the correct functioning of the device and is therefore not permitted.

The installation must be carried out according to the manufacturer's instructions. An incorrect installation may cause damage to people, animals or things, in which the manufacturer is not to be considered liable.

Modifications, adjustments, repairs, and reconfiguration must be carried out by the manufacturer or authorised persons.

In case problems arise do not attempt to personally repair the device.

The setting of configuration parameters must be carried out by qualified personnel. In any case the risks pertaining to incorrect settings do not constitute a danger for the patient.

Inadequate respect to any of the above-mentioned points may compromise the safety of the device.

Always respect the safety standards indicated for electrical devices, in particular:

- use only original accessories and spare parts
- do not immerse the device in any type of liquid
- do not touch the device with wet or damp hands
- do not leave the device exposed to atmospheric conditions
- place the device on a stable and a level working surface for all maintenance operations
- use of the device always requires full mental ability
- when unplugging the device, never pull the cable of the power supply or of the device
- always place the device on a suitable rigid horizontal on a stable surface with at least 30 cm (6 in) of space all around the device. The ventilation slots must be free from any cover or obstruction of any kind. The ventilation slots are located both behind and underneath the plastic outer casing of the device.

Before plugging in the charging unit, make sure that the electrical information on the label of the charging unit corresponds to those of the electrical wiring of the mains supply.

In case the plug of the charging unit supplied with the device is not compatible with the electric socket of the mains supply, contact qualified personnel for the substitution of the plug with a suitable one. Generally, it is not advisable to use adapters and/or extension cables. If it is essential to use them, then only those conform to the safety standards must be used, paying **WARNING** that they tolerate the maximum limits which are indicated on adapters and extension cables.

Unplug the power supply cable when battery charging is not required.

Do not leave the device attached to the mains supply when not required.

In case of breakdown or damage of the charging unit, replace it only with the manufacturer's original spare parts.

Use of an unsuitable power supply may change the performance of the device and no longer guarantee the safety conditions.
In order to avoid dangerous overheating we recommend to totally unwind the power supply cable of the charging unit.
The maintenance operations detailed in this manual must be carried out precisely. If these instructions are not followed this can cause measurement errors and/or incorrect test interpretation.
Before doing any cleaning and/or maintenance operations always switch off the device and unplug the power supply.
Keep the device out of reach of children and of any person with mental handicap.
When deciding to no longer use the device, it is recommended to dispose of it according to the local regulations.
In order to avoid contamination of the environment provoked by disposing of the spirometer, of its accessories, of plastic consumable materials or parts, follow all local regulations.
Device lithium backup battery life is 10 years.
Do not use the device beyond the estimated life advised by the manufacturer.
The lithium battery is continuously monitored by the device; if the battery is discharged, a warning message indicates that it must be replaced. Contact an authorised service centre to change the battery.
If the LED of the lithium back-up battery flashes, the test data and spirometry parameters in the memory, plus the device configuration then all information stored may be cancelled automatically.
The batteries used for power supply and for data storage are both inside the device. It is not permitted to open the device in order to replace them. This procedure must be carried out only in an authorised service centre, authorized by the manufacturer.
The maintenance operations detailed in this manual must be carried out to the letter. If these instructions are not followed this can cause measurement errors and/or an incorrect test interpretation.

1.2.1 Danger of cross-contamination

Two different types of turbine sensors can be used with the device, one is reusable and one is single-patient disposable. A mouthpiece is required in order to connect a subject to the spirometer. In order to avoid exposing the subject to the critical danger of cross-contamination, the reusable flow sensor must always be cleaned before each spirometry test, and always use a new disposable mouthpiece for each subject. The use of an anti bacterial filter is at the discretion of the doctor. If a single-patient disposable turbine is used, then a new one must be used for each patient.

1.2.2 Turbine

WARNING 



**Disposable
Turbine**

If you are going to perform the spirometry test with a “disposable” turbine it is of vital importance to use a new turbine for each patient. The characteristics, accuracy and the hygiene of the disposable turbine can only be guaranteed if it has been conserved beforehand in its original sealed packaging. The disposable turbine is made of plastic and its disposal after use must adhere to the local regulations and norms in force.



**Reusable
Turbine**

The correct functioning of the re-usable turbine can only be guaranteed if it has been cleaned in the correct manner and is free from foreign bodies, which could restrict its movement. If the turbine has not been cleaned sufficiently this could cause cross-contamination from one patient to another. Periodic cleaning should only be done when the instrument is for personal use and will only be used by one patient. The cleaning of the turbine should be performed according to the instructions contained in the User's Manual.

For cleaning operations see § MAINTENANCE AND CLEANING in this Manual.

The following information applies to both types of turbine:

The turbine must never be held under a jet of water or air and must never come into contact with high temperature fluids.

Do not allow dust or foreign bodies to enter the turbine sensor, in order to avoid incorrect functioning and possible damage. The presence of any impurities such as hair, sputum, threads etc. within the body of the turbine sensor may seriously compromise the accuracy of the measurements.

To avoid environmental contamination by cleaning waste products, the user must adhere to all relevant regulations.

1.2.3 Mouthpiece



Any disposable mouthpieces included with the device are supplied only as a guide to the correct type and dimensions of the mouthpiece required for this device, they are clean but not sterile.

To purchase appropriate mouthpieces, generally either paper or plastic, but in any case mono-use/disposable, we suggest that you contact your local distributor who supplied the spirometer.

WARNING 

Use a bio-compatible mouthpiece to avoid any problems to the patient; unsuitable materials could cause a bad functioning of the instrument, and therefore the test results could be incorrect.

The user is responsible for obtaining the correct type of mouthpieces for the device. Those required are a standard type with an outside diameter of 30 mm, they are commonly used and in general easily procured.

WARNING 

To avoid environmental contamination caused by the disposal of used mouthpieces, the user must adhere to all relevant local regulations.

1.2.4 Oximetry sensor

The following oximetry sensors can be used with *spiroLab III* :

MANUFACTURER	MANUFACTURER CODE	DESCRIPTION
BCI	1300	adult sensor (disposable)
BCI	3026	wrap-around sensor for infants
BCI	3043	universal Y sensor
BCI	3078	ear sensor
BCI	3178	pediatric finger sensor, reusable
BCI	3444	adult sensor reusable (Comfort Clip)
BCI	3044	adult sensor, reusable, for finger

These sensors require the use of an extension cable cod. 919100 to be correctly connected to the device.

The same sensors are also available with microconnector for the direct connection.

Prolonged use and/or the patient's condition may require changing of the sensor site periodically. Change sensor site and check skin integrity, circulatory status, and correct alignment at least every 4 hours.

WARNING 

Incorrectly applied sensors or damaged cables may cause inaccurate readings. Using a damaged sensor may cause inaccurate readings, possibly resulting in patient injury or death. Inspect each sensor before use.

If a sensor appears damaged then do not use it. Use another sensor or contact your authorized repair centre for assistance.

Use only MIR sensors supplied with, or specifically intended for use with the *spiroLab III*. Use of other types of sensors may cause inaccurate readings.

Oximetry measurements may be inaccurate in the presence of high ambient light. Shield the sensor area (with a surgical towel, for example) if necessary.

WARNING 

Dyes introduced into the bloodstream, such as methylene blue, indocyanine green, indigo carmine, patent blue V (PBV), and fluorescein may adversely affect the accuracy of the oximetry reading.

Any condition that restricts blood flow, such as the use of a blood pressure cuff or a device for systemic vascular resistance, may cause an inability to determine accurate pulse rate and SpO2 readings.

Remove fingernail polish and/or false fingernails before applying SpO2 sensors. Both may cause inaccurate oximetry measurement.

Significant levels of dysfunctional hemoglobins, such as carboxyhemoglobin or methemoglobin, may adversely affect the accuracy of the oximetry measurement.

Optical cross-talk can occur when two or more sensors are placed in close proximity. Optical cross-talk may adversely affect the accuracy of the oximetry readings. The danger can be eliminated by covering each site with opaque material. Obstructions or dirt on the sensor's emitter and/or detector may cause a sensor failure or inaccurate readings. Make sure there are no obstructions and that the sensor is clean.

Autoclaving and/or ethylene oxide sterilizing may cause sensor damage. Do not attempt to sterilize the sensor.

Unplug the sensor from SpirolabIII before cleaning or disinfecting, to prevent damaging the sensor or the device and to prevent safety hazards for the user.

Do not use the instrument in the presence of magnetic resonance imaging (MRI) equipment. MRI equipment may cause an induced current to the oximetry sensor, resulting in patient injury.

1.3 PROBLEMS AND UNFORSEEN ERRORS

In case of a problem, one of a series of messages will appear on the screen together with an acoustic signal to indicate the nature of the problem.

Operation of the device beyond its declared life could provoke a loss of data in the memory of the device (SRAM memory).

Errors in measurement or in interpretation can also be caused by:

- use by non-qualified or non-trained personnel, lacking ability or experience
- user error
- use of the instrument outside the guidelines described in this User's Manual
- use of the instrument even when some operational anomalies are encountered
- non-authorized servicing of the instrument
- improper, incorrect and/or unreasonable use of the product

WARNING 

**Following the European Directive:
93/42/EEC for MEDICAL DEVICES**
In the event of any accident caused by the device, the user must inform the manufacturer without delay.

1.4 LABELS AND SYMBOLS

Identification label of the spirometer model **SpirolabIII**



For color display



For black and white

The identification label located on the underside of the casing shows the product name, plus the following:

- Manufacturer's name and address
- Mark of conformity with the directive 93/42 EEC
- Serial number of the device

 EC mark for medical devices.
This product is certified to conform to the requirements of the 93/42/EEC medical devices directive.

 Electrical safety symbol. In accordance with IEC 60601-1, this product and its component parts are of type BF and therefore protected against the dangers of direct and indirect contact with electricity

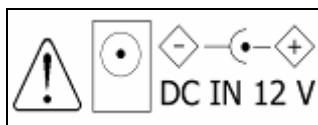

Warning symbol for the connection of the power supply.
To charge the internal battery use only and exclusively the original power supply (**12 V - 1A** DC) (MIR code 920665) guaranteed and certified to the EN 60601-1 Safety Standard.

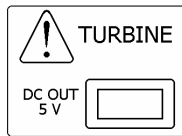

Warning symbol for the turbine connector.
Use only and exclusively the original turbine flow sensor.



Warning symbol for the serial port. To connect other devices such as PC or printer to the RS 232 serial port use only the serial cable supplied by the manufacturer and observe the safety regulations of EN 60601-1-1



Symbol laid down in the 2002/96/EEC requirements regarding the disposal of electrical and electronic devices, (WEEE). At the end of its useful life this device must not be thrown away with normal domestic waste, instead it must be delivered to a WEEE authorised collection centre.

An alternative is to return the device without charge to the dealer or distributor, when it is replaced by another equivalent device.

Due to the materials used in the manufacturing of the device, disposing it as a normal waste product could cause harm to the environment and/or to health.

Failure to observe these regulations can lead to prosecution.



For connection to other devices such as PC or printer. Use only the USB serial cable supplied by the manufacturer and observe the safety regulations of IEC 60601-1-1.



Warning symbol for the SpO2 port for oximetry.

FCC ID: TUK-MIR009

Warning symbol for the FCC

spirolab III complies with Part 15 of the FCC Rules. The correct operation is subject to the following conditions:

- (1) this device must not cause harmful interference
- (2) this device must accept any interference received, including interference that may cause undesired operation.

Any modifications not expressly approved by this company could void the user's authority to operate the device.

NOTE: This device has been tested and found to comply with the limits for a Class B digital device, pursuant to Part 15 of the FCC Rules. These limits are designed to

provide reasonable protection against harmful interference in a residential installation. This equipment generates, uses and can radiate radio frequency energy and, if not installed and used in accordance with the instructions, may cause harmful interference to radio communications.

However, there is no guarantee that interference will not occur in a particular installation. If this equipment does cause harmful interference to radio or television reception, which can be determined by turning the equipment off and on, the user is encouraged to try to correct the interference by one or more of the following measures:

- Re-orient or relocate the receiving antenna
- Increase the distance between the equipment and receiver
- Connect the equipment to a wall socket which is on a different circuit from that to which the receiver is connected.
- Consult the dealer or an experienced radio/TV technician for assistance.

1.5 TECHNICAL FEATURES OF THE SPIROMETER

Memory	Memory capacity for over 6000 spirometric tests. The precise number depends on the individual configuration, so it cannot be determined more closely
Interface	RS232, USB, Bluetooth
Flow/volume measurement system	Bi-directional digital turbine
Measurement method	Infrared interruption
Temperature sensor	Semiconductor (0-45°C)
Power supply	Rechargeable battery, Ni-MH, 6 elements 1.2V each, 4000 mAh
Batteries charger	Output voltage = 12 V, current = 1 A, compliant with EN 60601-1. Use exclusively battery charger provided from manufacturer (MIR code 920665)
Communication port/interface	RS232, bidirectional and optoisolated to 4KV
Wireless Communication	Bluetooth
Dimensions	310x200x65mm
Weight	1.9 kg
Volume range	10 L
Flow range	16 L/s
Volume accuracy	± 3% or 50 mL
Flow accuracy	± 5% or 200 mL/s
Dynamic resistance at 12 L/s	<0.5 cm H ₂ O/L/s

Type of electrical protection	Class II device
Safety level for shock hazard	Type BF Apparatus
Protection against water ingress	IPX0
Safety levels during use in presence of inflammable anaesthetic gases or oxygen or nitrogen	Apparatus not suitable
Conditions of use	Apparatus for continuous use
Conditions of storage	Temperature: MIN -20 °C, MAX + 60 °C Humidity: MIN 10% RH; MAX 95%RH
Operating Conditions	Temperature: MIN + 10 °C, MAX + 40 °C Humidity: MIN 10% RH, MAX 95%RH
Applied norms	Electrical Safety Standard EN 60601 Electro Magnetic Compatibility EN 60601
Life expectancy	About 10 years.

Storing of parameters, Flow/Volume and Volume/time curves. The number of tests cannot be precisely defined as it depends on the set up made by the individual user.

Display:

spirolab III B/W: Graphic LCD passive type FSTN 320x240 Pixel

spirolab III colour: Graphic LCD 16 colour passive type FSTN 320x240 Pixel

Keyboard:

Silicon rubber keyboard

- 07 Hardware function keys, with symbols
- 15 Software function keys, with symbols
- 05 Arrow keys with symbols (right, left, up, down, enter)
- 02 Gender identification with appropriate symbols
- 10 Number keys
- 29 International alphabet keys.

WARNING 

This device is a Class IIa medical device, according to the European Directive 93/42/EEC, annex IX, rule 10.

1.6 TECHNICAL SPECIFICATIONS

1.6.1 Features of the spirometer

Measured parameters:

SYMBOL	DESCRIPTION	Units
*FVC	Best FVC	L
*FEV1	Best FEV1	L
*PEF	Best PEF	L/s
*FEV1/FVC	Best FEV1/FVC	
FVC	Forced Vital Capacity	L
FEV1	Volume expired in the 1 st second of the test	L
FEV1/FVC	FEV1/FVC x 100	%
FEV1/VC	FEV1 / best between EVC and IVC x 100	%
PEF	Peak expiratory flow	L/s
FEF2575	Average flow between 25% and 75% of the FVC	L/s
FEF25	Forced Expiratory Flow at 25% of FVC	L/s
FEF50	Forced Expiratory Flow at 50% of FVC	L/s
FEF75	Forced Expiratory Flow at 75% of FVC	L/s
FEV3	Volume expired in the initial 3 seconds of the test	L
FEV3/FVC	FEV3/FVC x 100	%
FEV6	Volume expired in the initial 6 seconds of the test	L
FEV1/FEV6	FEV1/FEV6 x 100	%
FET	Forced expiratory time	s
VEXT	Extrapolated volume	mL
FIVC	Forced inspiratory volume	L
FIV1	Volume inspired in the 1 st second of the test	L
FIV1/FIVC	FIV1/FIVC x 100	%
PIF	Peak inspiratory flow	L/s
MVVcal	Maximum voluntary ventilation calculated from the FEV1	L/s
VC	Slow vital capacity (expiratory)	L
ELA	Estimated lung age	years
IVC	Slow inspiratory vital capacity	L
IC	Inspiratory capacity (max between EVC and IVC - ERV)	L
ERV	Expiratory reserve volume	L
TV	Current volume	L
VE	Ventilation per minute, at rest	L/min
RR	Respiratory frequency	Breath/min
t _i	Average time of inspiration, at rest	s
t _e	Average time of expiration, at rest	s
TV/t _i	Average flow of inspiration, at rest	L/min
t _i /T _{tot}	t _e /(t _i +t _e)	/
MVV	Maximum voluntary ventilation	L/min

*= best values

1.6.2 Features of the oximeter

Measurement method:	Red and infrared absorption
Range of measurement %SpO₂:	0 – 99% (with 1% increments)
%SpO₂ accuracy:	± 2% between 70-99% SpO ₂
Average number of heart beats for the %SpO₂ calculation:	8 beats
Range of measurement of cardiac pulse:	30 – 254 BPM (with 1 BPM increments)
Accuracy of cardiac pulse:	± 2 BPM or 2%
Average interval for the calculation of cardiac pulse:	8 seconds
Signal quality indication:	0 - 8 segments on display

Definitions:

Desaturation Event	Desaturation events SpO ₂ fall >= 4% in a limited period of 8-40 sec and successive rise > = 2% within a total period of 150 sec.
Total Pulse rate Variation	Pulse rate rise >= 10 BPM in limited period of 8-40 sec and successive fall >=8 BPM during a total period of 150 sec.

Parameters measured during sleep oximetry:

SYMBOL	DESCRIPTION	Units
SpO ₂ Baseline	SpO ₂ Average in first three minutes	%
SpO ₂ Min	SpO ₂ Minimum during analysis period	%
SpO ₂ Max	SpO ₂ Maximum during analysis period	%
SpO ₂ Mean	SpO ₂ Average during analysis period	%
BPM Baseline	Average pulse frequency in the first 3 minutes	BPM
BPM Min	Minimum pulse frequency during the analysis period	BPM
BPM Max	Maximum pulse frequency during the analysis period	BPM
BPM Mean	Average pulse frequency during the analysis period	BPM
Recording time	Total time measure of SpO ₂	hh:mm:ss
Analysis Time	Total time of analysis	hh:mm:ss
T90	Time passed with SpO ₂ < 90 %	% hh:mm:ss
T89	Time passed with SpO ₂ < 89 %	% hh:mm:ss
T88	Time passed with SpO ₂ < 88 %	% hh:mm:ss
T87	Time passed with SpO ₂ < 87 %	% hh:mm:ss
N SpO ₂ . Events <89%	Fall of SpO ₂ below 89% for at least 20 seconds	\
Δ Index (12ses)	Index of SpO ₂ fluctuation calculated in intervals of 12 sec.	\
T< 40 BPM	Time passed with pulse frequency < 40 BPM	% hh:mm:ss
T> 120 BPM	Time passed with pulse frequency > 120 BPM	% hh:mm:ss
Bradycar. Events < 40 BPM	Bradycardia events during the entire analysis period	\

Tachycar. Events>120 BPM	Tachycardia events during the entire analysis period	\
Total Desat. Events	Desaturation events during the entire analysis period	\
ODI	Desaturation events per hour of analysis	1/h
Mean Duration	Average duration of desaturation events	s
Longest Duration	Longest duration of desaturation events	s
Desaturation Peak	Minimum SpO2 during desaturation events	%
Mean Desaturation	Average duration of desaturation events	%
Mean Drop SpO2	Average SpO2 fall with respect to baseline, during the desaturation events	%
Max Drop SpO2	Maximum fall of SpO2 with respect of baseline, during the desaturation events	%
N. Pulse Variations	Variation of pulse frequency events during the entire analysis period	\
Pulse Index	Variation of pulse frequency by hour of analysis	1/h
NOD 4%	Time passed with SpO2 < 4 % with respect to SpO2 base for continual periods above 5 minutes	\ hh:mm:ss
NOD 89%	Time passed with SpO2 < 89 % for continued periods above 5 minutes	\ hh:mm:ss
NOD 90%	Time passed with SpO2 < 90 % for continued periods above 5 minutes with minimum value < 86 % (Nadir)	\ hh:mm:ss

Δ=DELTA

Parameters measured during exercise test:

SYMBOL	DESCRIPTION	Units
SpO2 Baseline	SpO2 average before exercise	%
SpO2 End	SpO2 after exercise	%
SpO2 Min	SpO2 minimum during exercise	%
SpO2 Max	SpO2 maximum during exercise	%
SpO2 Mean	SpO2 average during exercise	%
BPM Baseline	Average pulse frequency before exercise	BPM
BPM End	Pulse frequency after exercise	BPM
BPM Min	Pulse frequency minimum during exercise	BPM
BPM Max	Pulse frequency maximum during exercise	BPM
BPM Mean	Pulse frequency average during exercise	BPM
T90	Time passed with SpO2 < 90 %	% hh:mm:ss
T89	Time passed with SpO2 < 89 %	% hh:mm:ss
T88	Time passed with SpO2 < 88 %	% hh:mm:ss
T87	Time passed with SpO2 < 87 %	% hh:mm:ss
T2 [ΔSpO2 ≥ 2%]	Time passed during exercise test with SpO2 < 2 % with respect to SpO2 base	hh:mm:ss
T4 [ΔSpO2 ≥ 4%]	Time passed during SpO2 exercise test < 4 % with respect to SpO2 base	hh:mm:ss

T < 40 BPM	Time passed with pulse frequency < 40 BPM	hh:mm:ss
T > 120 BPM	Time passed with pulse frequency > 120 BPM	hh:mm:ss
Bradycar. Events < 40 BPM	Bradycardia events during the entire period of analysis	\
Tachycar. Events > 120 BPM	Tachycardia events during the entire period of analysis	\
Recording Time	Total time measure of SpO2	hh:mm:ss
Analysis Time	Total time of analysis	hh:mm:ss
Baseline Time	Duration of baseline phase	hh:mm:ss
Exercise Time	Duration of exercise phase	hh:mm:ss
Recovery Time	Time for SpO2 value \geq 99% of the average base value calculated during the initial phase of the test.	hh:mm:ss
DYSPNEA Baseline	Variation in grade of dyspnea during Baseline	\
DYSPNEA End	Final grade of dyspnea	\
DYSPNEA CHG	Variation in grade of dyspnea during exercise	\
FATIGUE Baseline	Variation in grade of fatigue during Baseline	\
FATIGUE End	Final grade of fatigue	\
Fatigue CHG	Variations in level of fatigue during exercise	\

Δ =DELTA

Parameters required for exercise test:

SYMBOL	DESCRIPTION	Units
Baseline DYSPNEA	Grade of dyspnea before exercise	\
Final DYSPNEA	Grade of dyspnea after exercise	\
Baseline FATIGUE	Level of fatigue before exercise	\
Final FATIGUE	Level of fatigue after exercise	\

Parameters measured with SpO2 Analysis:

SYMBOL	DESCRIPTION	Units
SpO2 Baseline	SpO2 Average in first three minutes	%
SpO2 Min	SpO2 Minimum during analysis period	%
SpO2 Max	SpO2 Maximum during analysis period	%
SpO2 Mean	SpO2 Average during analysis period	%
BPM Baseline	Average pulse frequency in the first 3 minutes	BPM
BPM Min	Minimum pulse frequency during the analysis period	BPM
BPM Max	Maximum pulse frequency during the analysis period	BPM
BPM Mean	Average pulse frequency during the analysis period	BPM
Recording time	Total time measure of SpO2	hh:mm:ss
Analysis Time	Total time of analysis	hh:mm:ss
T90	Time passed with SpO2 < 90 %	% hh:mm:ss

T89	Time passed with SpO2 < 89 %	%	hh:mm:ss
T88	Time passed with SpO2 < 88 %	%	hh:mm:ss
T87	Time passed with SpO2 < 87 %	%	hh:mm:ss
N. SpO2 Events < 89%	Fall of SpO2 below 89 % for at least 20 seconds	\	
Δ Index (12sec)	Index of SpO2 fluctuation calculated in intervals of 12 seconds	\	
T< 40 BPM	Time passed with pulse frequency < 40 BPM	%	hh:mm:ss
T> 120 BPM	Time passed with pulse frequency > 120 BPM	%	hh:mm:ss
Bradycar. Events < 40 BPM	Bradycardia events during the entire analysis period	\	
Tachycar. Events>120 BPM	Tachycardia events during the entire analysis period	\	

Δ =DELTA

Acoustic signals for oximetry:

- Beep with frequency of the cardiac pulse
- Continuous beep in the case of either %SpO₂ or cardiac pulse going outside of the programmed alarm levels
- Continuous beep during oximetry measurement in the case of low battery level
- If the patient's finger is not inserted correctly or the connector is not properly attached there will be an intermittent beeping sound for 10 seconds
- If the test has been interrupted due to low battery power an intermittent beeping will be heard for 10 seconds when the device is switched on again

The specifications for both the oximetry and for the cardiac pulse are the same, regardless of which of the above mentioned oximetry sensors is used.

2 PRODUCT DESCRIPTION

Spirolab III is a spirometer with an optional pulse oximetry module that facilitates the total valuation of lung function. It is a powerful and compact measurement device intended for use by a physician (respiratory specialist), and which is capable of calculating more than 30 spirometric parameters.

Spirolab III is able to make FVC, VC, IVC, MVV and breathing profile tests, as well as the saturation of oxygen in the blood and the heart beat.

It can operate in stand alone mode, and it can be connected to a PC or to a printer using any one of several available methods: RS232, USB, Bluetooth.

It calculates an index of test acceptability (test quality control) and a measure of reproducibility; It also gives functional interpretation with 11 possible levels following the latest **ATS** (American Thoracic Society) classification; it has an internal memory sufficient for over 6000 spirometry tests or for 1000 hours (or 40 days) of oximetry monitoring.

The main spirometric parameters are measured and displayed and all data with Flow/Volume and Volume/time curves can be printed out in seconds by the built-in thermal printer. The Flow/Volume curve is shown in real time on the display.

Each test can be repeated as required. The best parameters are always available for quick viewing or printing. The normal (predicted) values can be selected from five different authors. In general, within the European Union the ERS (European Respiratory Society) predicted values are used.

The device also calculates the response to drug administration, i.e., the percentage change between spirometry results obtained before and after the subject takes a drug) and the results of a bronchial challenge test or a bronchodilation test. A comparison of data is made between POST (after-drug) and PRE (before drug administration).

The flow and volume measurement sensor is a digital turbine, based on the infrared interruption principal. This principal ensures the accuracy and the reproducibility of the measurements without requiring a periodic calibration.

The main features of this kind of sensor are listed below:

- Accurate measurement even at very low flow rates (end of expiration)
- Not influenced by gas humidity nor density
- Shockproof and unbreakable
- Inexpensive to replace

The turbine flow measurement sensor is available both in reusable and in single-patient disposable versions.



REUSABLE TURBINE



DISPOSABLE TURBINE

The following precautions must be observed to ensure that the characteristics of the turbine remain unaltered over time:

- For the disposable turbine: must always be substituted between patients.
- For the reusable turbine: always clean the turbine between patients, to ensure the maximum level of hygiene and safety for the patient.

For a correct interpretation of a spirometry test, the measured values must be compared either with the so-called **normal** or **predicted values** which are calculated from the anthropometric details of the patient or, alternatively, with the **personal best values** from the clinical history of the subject.

The personal best values can vary considerably from the predicted values, which are taken from "healthy" subjects.

Spirolab III is supplied with an RS-232 optoisolated serial communication port, which guarantees excellent electrical protection (> 4 KV) both for the health care worker and for the subject, in compliance with the most strict European safety standards (EN 60601-1). The Bluetooth connection system can be used to connect the device directly to a printer (the Bluetooth system must be installed and enabled on the printer as well).

Spirolab III can also be connected to a PC (or to another computerised system) to configure the system. All spirometric test results plus the related subject details stored inside the device can be transferred from the device to the PC and then viewed within the winspiroPRO PC software (Flow/volume curves, spirometry parameters, plus optional oximetry parameters).

The connection to the PC can be made in the following ways:

- through the RS232 port or
- through the USB port

The internal software (or firmware) of the device can be upgraded quickly and simply from a PC.

For upgrading the system consult the manufacturer or an authorized representative.

spirolab III gives an automatic interpretation of each spirometry test carried out, and assigns a “traffic light” feedback (green, yellow or red) to each test or series of tests. The set up of the traffic light settings is made by the doctor responsible for the system configuration.

Oximetry function

The oximetry sensor has two light emitting diodes (LEDs), one emits in the visible spectrum and one infrared. Both lights then pass through the finger and are “read” by the receiver. As these lights pass through the finger, a proportion of the light is absorbed by the blood and by the soft tissue, in function of the concentration of haemoglobin. The quantity of light absorbed, at each frequency, depends on the degree of oxygenation of the haemoglobin inside the soft tissue.

This measurement principle ensures accuracy and reproducibility, without requiring regular calibration.

The oximetry sensor can be disinfected with isopropilic alcohol for more information see paragraph 4.3.

The operating battery is a 3.6V lithium battery.





2.1 ILLUSTRATION OF SPIROLAB III





















1. MiniFlowmeter sensor
2. Thermal paper container
3. Flow sensor compartment
4. Display
5. Keyboard
6. Oximeter sensor



2.2 KEYBOARD



SYMBOL	DESCRIPTION
	On/Off
	Adjust contrast, press several times as required
	Adjust brightness, press several times as required
	Advance the printer paper
	Self-check key

	Cancel the current operation
	Select configuration menu
	Correction key/cancel last data inserted
	Information about options
	View data in memory
	Enter/modify patient data
	View best test
	View last test
	View last oximetry test
	Make POST test
	Make oximetry test
	Print
	Make FVC test
	Make VC test
	Make MVV test
	Number keys
	Specifies female sex
	Specifies male sex
	Confirm last operation. This key is the ENTER key
	Move cursor

2.3 CHARGING THE BATTERY

WARNING

spirolab III is powered only by the internal batteries; the battery charger is used only to charge the internal batteries. In the charging phase the device can be used only after the internal batteries have recovered a minimum charge level.

WARNING ⚠

For charging internal battery of spirolab III use exclusively the battery charger provided with the device (MIR code 920665)

Make sure that the electrical information on the label of the charging unit corresponds to that of the power source.

Plug the power supply into an electrical outlet.

Plug the power supply jack into the socket on the back of the device.

Do not use the power supply if it is wet or damp.

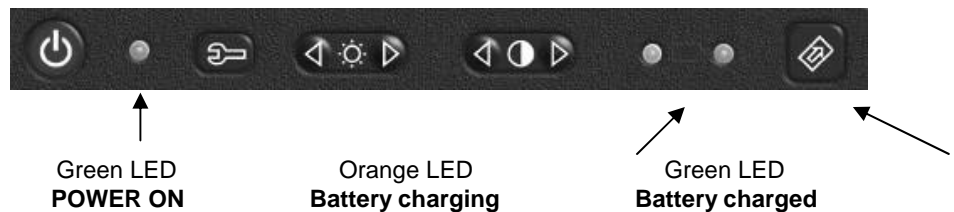

The charging process has several phrases which are indicated by two LEDs, green and orange (as shown above).

- Immediately after connecting the power supply, the orange LED starts to flash.
- After a few seconds the orange LED stops flashing and remains lit.
- For about 10 minutes the charging is partial while device automatically checks the battery condition.
- After about 10 minutes the charging starts and proceeds to a full charge.
- When charging is completed, the orange LED turns off and the green LED lights up.

WARNING ⚠

It is possible that during battery charging there may be a slight increase of a few degrees in the temperature of the power supply. Always place the device on a suitable rigid horizontal on a stable surface with at least 30 cm (6 in) of space all around the device. The ventilation slots must be free from any cover or obstruction of any kind, they are located both behind and underneath the plastic outer casing of the device.

2.4 SWITCHING ON THE SPIROMETER

First check that all the accessory items are in good condition.

Before using the device proceed with the cleaning operations, as described in the MAINTENANCE AND CLEANING section.

Lift the LCD display, release the catch.

Press the red  on/off key on the upper left corner of the keyboard. When the device is on, the green led on the right hand side of the on/off key will light up.

WARNING 

When the device is connected to a PC via a USB cable then it will automatically power on, as the power supply is internal.

2.5 SETTINGS

Backlight settings

To adjust the brightness of the display back light use the double key . Press several times as required, on the left to diminish the brightness or on the right to increase it.

2.5.1 Contrast settings

To adjust the display contrast, to account for the angle of vision and the surrounding lighting, use the double key . Press several times as required, on the left to diminish the contrast or on the right to increase it.

2.5.2 Loading the thermal paper

Open the lid of the thermal paper compartment and remove it from the device; remove the paper roll holder.

Insert the new roll of paper onto the paper roll holder.

WARNING 

The thermal paper must be inserted as shown in this picture, paying WARNING to the position of the paper holder roll pins inside the guides and to the direction of the roll, so that printing occurs on the correct side of the thermal paper. Note that the thermal paper cannot be printed on both sides but only on the one face-up of the paper roll.

Guide to the correct positioning of the paper roll holder

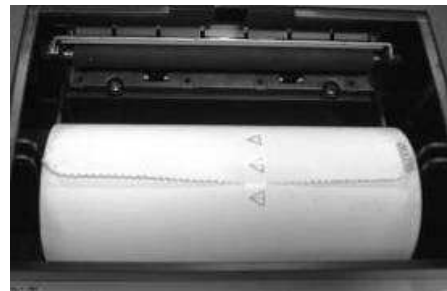

Push the paper into the slot located under the traction reel (black rubber reel).

A sensor (as indicated in the image) detects the paper and automatically advances it.

This image shows the position of the paper in relation to the traction reel. The paper must advance through the slot in the compartment when it is closed; close the lid of the compartment.

If necessary make the paper advance manually by pressing 

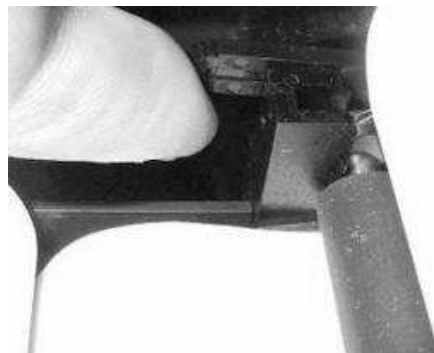

WARNING 

To avoid damage to the printer and/or defects in printing, it is recommended to use thermal paper with 112 mm width size. The sensibility of the thermal paper must be suitable for printers with a printing speed of 50 mm/s. This type of paper is easy to find at most medical device dealers.

2.5.3 Connecting the flow sensor

The flow sensor is made up of the elements shown in the following illustration.

Before carrying out a spirometry test, verify that there are no foreign bodies present inside the flow sensor.

Connect the connection cable to the Miniflowmeter until hearing the 'click' which indicates that it has been correctly inserted. Connect the other end to the **spirolab III** as shown in the image; again the 'click' will indicate the correct insertion.

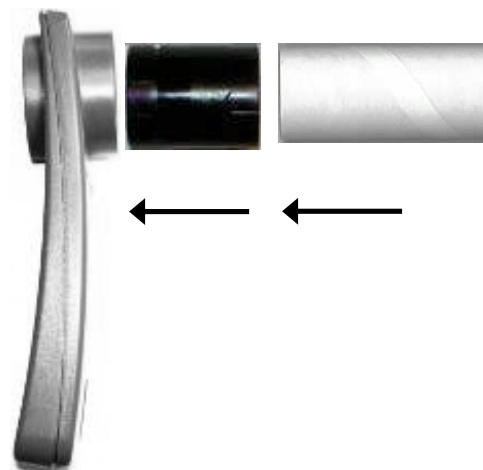

Miniflowmeter Turbine Mouthpiece

Make sure that a new disposable mouthpiece has been correctly inserted in the turbine (mouthpiece holder).

WARNING 

Follow carefully all of the instructions given in the various paragraphs of this manual, to ensure that all of the functions operate correctly.

Remove the used mouthpiece and dispose of it after finishing the spirometry testing.

When the flow sensor head is not in use, we recommend that it is kept in its compartment.

Press lightly on the connector to detach the flow sensor turbine from the socket on the left hand side of the device and proceed with the cleaning operations as outlined in the MAINTENANCE CLEANING section of the manual.



2.5.4 Switching off the spirometer

The device has an auto power-off system for reducing battery consumption. This feature can be set up from the menu by selecting one of the following 3 options: 6, 60 or 240 minutes; the device will automatically switch off upon reaching the pre-set time, when no activity has been made for that time.

If instead the device remains switched on when all operations are complete, switch it off manually by pressing . When the device is switched off, the green (LED) indicator on the right hand side of the on/off key should also be off. When the battery does not need charging then be sure to detach the power supply from the power supply socket on the back of the device and remove the charger from the mains supply.

2.5.5 Initial settings





WARNING

The sections of this Manual contained in a frame correspond to the wording shown on the screen of the device.

spirolab III allows for the personalised setting of certain parameters through the Configuration Menu.

To access the configuration menu, with the device switched on, press  which contains the following list:

- Delete data in memory
- Print last calibration
- Turbine calibration
- Printout header text
- Change Date/Time
- Choose operating language
- Choose predicted values
- Setup parameters/printout
- Bluetooth settings
- Oximetry settings
- Incentive
- Turbine type
- Standard
- Date format
- Units format
- Auto power-off

Select the required option using  or , until the  symbol on the left of the screen is alongside your selection; then press  to access the option.

 Use this key to recall the Configuration Menu, to set-up and/or to change certain main functions of the device.

Delete data in memory

To delete all the data in memory.
The display will show:

Use  to quit without deleting the test data.

The password is: **122333**

After deleting the data in memory, the display shows:

If the password is entered incorrectly, the display shows:

DELETE DATA IN MEMORY
WARNING! ALL SPIROMETRY TESTS IN
MEMORY WILL BE DELETED.
TO PROCEED INSERT PASSWORD
()

Test data has been DELETED!

Available memory is: 100%

PRESS ANY KEY TO EXIT

PASSWORD INCORRECT
ENTER to Retry

ESC to Quit

Press  to repeat the procedure.

Print last calibration

To print the turbine calibration coefficient currently in use plus the date of the last calibration made.

Turbine calibration

WARNING 

The turbine flow sensor does not require calibration but needs only regular cleaning. If a calibration must be made then the following guidelines must be carefully noted.
Only the reusable turbine can be calibrated.

NOTE

**Each time a calibration is made, the new correction factor is algebraically added to the previous correction factors. Therefore, before making a new calibration, make sure to delete the actual calibration in use as described above.
For an accurate and reliable calibration the syringe volume must be at least 3 L.**

To modify the calibration of the turbine based on the **FVC** values (for the expiratory phase) and **FIVC** (for the inspiratory phase), measured during a test made with a calibration syringe.

From configuration menu choosing "turbine calibration", on the display appears the following informations.

The values "last FVC" and "last FIVC" are retained to the last calibration. The values under the "ERR" column indicate the actual correction. They are set on 0 for default.

SYRINGE VOLUME cL: 300		
OLD CALIBRATION		
	BTPS	%ERR
FVC	300	0
FIVC	300	0
NEW CALIBRATION		
ATP		
FVC		
FIVC		
%ERR	= TOTAL ERROR	
BTPS	= Measure condition	
ATP	= Conversion from BTPS	
If FVC and FIVC =0 then use factory calibration		
ESC to Quit		

WARNING 

**ATP stands for Ambient Temperature and Pressure which indicates that the measurement conditions are ambient temperature and pressure.
BTPS stands for Body Temperature and Pressure Saturated which represents a world standard reference condition for the measurement of spirometric parameters. All spirometric parameters are calculated at body temperature (37 °C) and pressure saturated.**

**In line with the publication "STANDARDISED LUNG FUNCTION TESTING" of the European Respiratory Society (Vol 6, Supplement 16, March 1993), the air expired from the mouth is at a temperature of circa 33/34 °C.
The expired flow and volume, to be converted back to BTPS conditions (37 °C), must be increased by 2.6% - this is derived from the BTPS factor of 1.026 at a temperature of 33°C, which represents a correction of 2.6%. In practice the BTPS factor for the expired flow and volumes is therefore constant and equal to 1.026.
For the inspired volumes and flows, the BTPS factor depends instead upon the ambient temperature, as the inspired air is at ambient temperature.
For instance, at an ambient temperature of 20°C with relative humidity at 50%, the BTPS factor is 1.102, a correction of +10.2%.**

The correction of the inspired volumes and flows is made automatically, as the device has an internal temperature sensor; all parameters are thus reported at BTPS.

To make the calibration:

1 - Insert the volume in **cL** of the calibration syringe in use (e.g. for a 3L syringe, insert 300 cL).

2 - Insert both the FVC and FIVC values, obtained by the measurement made with the calibration syringe, in the New FVC and New FIVC field. Use vertical scrolls to select the value to be modified (SIRIN, New FVC, New FIVC).

Use numeric keys to modify the parameter value selected.

If the calculated correction factors are acceptable (<20%), they are displayed beside the New FVC and New FIVC parameters.

Press ESC to return to the configuration Menu without entering the correction.

If the FVC and FIVC values produce a correction factor that is >20%, the FVC and FIVC values will not be accepted. This means that the system cannot correct for such a large calibration error. The following message appears:

WARNING ! ERROR too high

In this case:

- Check the correct functioning of the **spirolab III** with a new turbine and/or
- Clean the turbine.

To erase the calibration in use and reset to the factory calibration, input **0** in the New FVC and New FIVC fields.

Then press  to return to the Configuration Menu.

WARNING 

**With the new calibration, the correction factors are algebraically added to the previous correction factor(s).
Before to begin a new calibration set the two values FVC and FIVC at 0, then repeat the calibration procedure.
If a 3L syringe is used to make the calibration and if the spirometer is calibrated correctly then the FVC (syringe) value will be:
 $3.00 \text{ (FVC)} \times 1.026 \text{ (BTPS)} = 3.08 \text{ L (FVC at BTPS)}$.
If the ambient temperature is 20°C, the FIVC (syringe) value will be:
 $3.00 \text{ (FIVC)} \times 1.102 \text{ (BTPS)} = 3.31 \text{ L (FIVC at BTPS)}$.
The user must be aware that the volume of the syringe shown by the machine is converted to BTPS conditions, so that the "increase" of the results with respect to the expected values does not constitute an error.**

**For instance, if the calibration procedure is carried out with measured data:
 20 ° C, FVC = 3.08, FIVC = 3.30
 the spirometer is perfectly calibrated and the relative correction factors are null. No
 calibration is required!
 This does not represent an error, but is a logical consequence of the above detailed
 explanation.**

Printer header text

To insert a header that will be printed at the beginning of each spirometry report (see image).

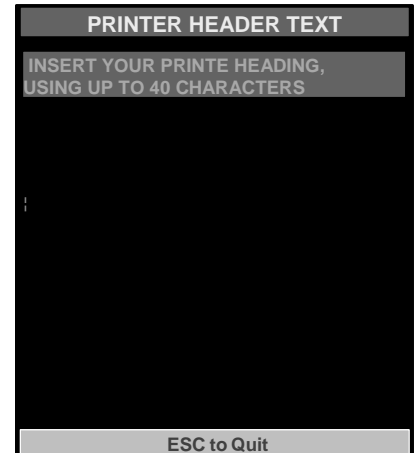

Change DATE/TIME

To change the date and time.
 The time is shown in the 24 hour format.

Select language

To change the language used for displaying messages on the screen and the printouts.

Select predicted values

To select one of the standards available for the calculation of the predicted values. The parameters are organized in the following way:

REFERENCE	ADULTS	CHILDREN
1	ERS	Knudson
2	Knudson	Knudson
3	Morris/Bass	Knudson
4	ERS	Zapletal
5	MC-Barcelona	Zapletal

Select with the numeric keys the reference number, automatically the chosen values will set and the display shows the configuration menu.

Select printout

To enable or disable the printout of spirometry parameters; in addition this menu allows to set-up, enable or disable the printout of the F/V and V/t curves.

Bluetooth settings

Select this function and the following menu is shown:

- Search Device
- Options PRINTER
- Options PHONE
- Remote line Number

Search Device

Select the required option with ► and confirm with ↵; **spirolab III** begins to search for Bluetooth active devices; when one or more active devices are found then a list is shown, select a device and push ↵ to define the device (with vertical scroll) as a printer or as a phone (use PRINTER or PHONE); select one of the two options and push ↵, otherwise

push  to return to the Bluetooth options. If the device is already present in the chosen list a warning message will be shown on the display; push a key to turn to the devices list.

Options PRINTER

To control the devices memorized within the “printers list”. Enter the list with ↵ and having selected a device it is possible:

- to set the device as default, identified with a yellow point near the device name (so **spirolab III** will automatically connect to this)
- to delete the device from the list (**spirolab III** asks for a confirmation by pressing ↵, otherwise press  to return to the Bluetooth options and **not** delete the device from the list).

If no devices are shown then a message advises the user to search for active devices; press ↵ to start the search or  to return to the Bluetooth settings.



Options PHONE

To control the devices memorized in the “printers list”. Enter the list with ↵ and having selected a device it is possible:

- to set the device as default, identified with a yellow point near the device name (and **spirolab III** will automatically connect to this)
- to delete the device from the list (**spirolab III** asks for a confirmation by pressing ↵, otherwise press  to return to the Bluetooth options and **not** delete the device from the list).

Even if the list is empty, a search can be made for active devices as previously described.



Remote line Number

Enter the menu with  then it is possible to insert the telephone number that **spiroLab III** will use to connect to a Bluetooth telephone. Insert the required number using the numeric keyboard and then press .

Oximetry settings

This function permits the following kinds of setting up :

- reference values for SpO2 and BPM; if, during a test, these values go below the minimum or above the maximum values in the set up an acoustic alarm will ring to alert the user
- activation/disactivation of the acoustic alarm
- set the sampling time (2 or 4 seconds) of oximetry values during a test

The cursor at the beginning will rest on the minimum SpO2 value, use the numeric keys to select the desired value, then the cursor automatically pass to the next value; if a value must not be modified press ; once the four values have been set up you can then, if required, activate or deactivate the acoustic alarm by pressing key 1 for OFF and key 2 for ON. To confirm the selection press . Then is possible to set the sampling time: press key 2 to set 2 sec or press key 4 to set 4 sec. Pressing  the configuration menu is displayed.

Incentive

spiroLab III has a pediatric incentive program which can be useful to help a child (or an older person) make a correct spirometry test. The incentive is a hidden image, directly connected to the signal coming from the MiniFlowmeter so the harder the expiration then the further the "curtain" moves away, revealing the image and thus helping the patient to obtain the best possible result.

When the pediatric incentive is selected, a warning message is shown asking for the age of the patient. Set the correct value, the configuration menu is then shown.

Given that the FVC test requires collaboration that is difficult to obtain in children under the age of 4, then if an age of 4 or below is selected then **spiroLab III** automatically shows the incentive during the FVC test.

Turbine setup

Select the type of turbine to be used for testing, either single-patient disposable or reusable. To select the correct option, follow the steps as described previously selecting the required item and press v to change the option.

Standard

To select one of the available standards: ATS/ERS or NANHES III, press .

DATE format: dd/mm/yy

To select the required format, toggles between dd/mm/yy or mm/dd/yy or yy/mm/dd or vice versa.

Press  to toggle.

UNITS format: cm, kg

To change the units format from cm, kg to in, lb (inches and pounds) or vice versa. Press  to toggle.

Auto power-off: 6 min

To change the wait-time for auto power off to 6 min, 60 min or after 240 min. Press  to toggle.

2.5.6 Functioning of the spirometer

spirolab III performs the following measurements:

The valuation and interpretation of test results are given by comparing the measured parameters with specific 'normal' spirometry values (known as predicted values) which are calculated from subject data: age, height, weight, sex and ethnic group.

FVC	Forced Vital Capacity
VC	Slow Vital Capacity
MVV	Maximum Voluntary Ventilation
SpO₂	SpO ₂ /BPM

For the calculation of the predicted values, there are several different sets available both for adults and for children.

For adults	ERS (European Respiratory Society)
“	Knudson
“	Morris/Bass
“	Multicentrico Barcellona
For children	Knudson
“	Zapletal

After each test session the results are compared to the selected predicted values and the percentage ratio between measured and predicted is shown for each parameter.

$$\% \text{ Predicted} = \frac{\text{Measured}}{\text{Predicted}} \times 100$$

The test can be repeated more than once and the best result is memorized in order to be recalled from the **spirolab III**'s memory.

The best test result is determined following the ATS/ERS standards.

In practice, the best test is the one having the highest sum of FVC+FEV1.

All tests are analyzed by applying the quality criteria (quality control), following the ATS standards. In addition, the reproducibility of the FEV1, FVC and PEF parameters are also calculated.

It is possible to perform POST drug testing, in this case the test results are compared to a test made prior to the administration of drugs (PRE-test).

spirolab III displays and prints the Flow/Volume and the Volume/time curves superimposed, with PRE and POST parameter comparison and percentage of change:

$$\% \text{ PRE} = \frac{\text{Value POST}}{\text{Value PRE}} \times 100$$

After switching on the device, the main screen will show a summary of the current patient data. Some values shown are as follows:

v. x.y

Indicates the version of the software (firmware) inside the spirometer. In case of technical problems always note this version number.

DATE AND TIME

The current date and time, which can be modified from the Configuration Menu.



PRE

The first test for each new subject is a PRE type, i.e. without drug administration. For the POST test i.e. after the administration of drugs, see Paragraph 2.6.2 POST in this Manual.

FILE

spirolab III assigns a progressive number to each new PRE, POST or SpO2/BPM oximetry test.

LAST NAME AND NAME

Are displayed data of the last patient inserted

#ID

Indicates the subject number or identification code which is inserted by the user.

TYPE OF TURBINE

STANDARD IN USE

BTSPS (Body Temperature Pressure Saturated)

2.5.7 New subject data entry



Press

The lower part of the screen will show the following message:

CHANGE ◀ ▶ **NEW**

Use ◀ or ▶ to modify patient data of patient displayed, otherwise insert new details.

SUBJECT NAME AND SURNAME

Use ◀ or ▶ to modify data of a patient already inserted, or to enter the details of a new patient.

Enter the required information using the cursor positioned on the subject's surname. Use ◀ to go to the next entry.

All data entered must be confirmed with ◀ or cancelled with . To modify a number after it has been entered use ▲; to return the cursor to the area required, to enter the correct numerical value and go to the next entry press ◀.

#ID

Insert the patient ID code: this code is alphanumerical and can be a maximum combination of 16 characters; this code enables the quick recall of any patient data when required.

Recall a subject from memory and press the #ID key to create a new test session with the anthropometric details of the same subject. This avoids having to reinsert all of the data of that patient.

If the ID code inserted already exists in memory then the following message appears:

**WARNING! #ID ALREADY ASSIGNED
CONFIRM ID CODE OR MODIFY**

The user may either exit, enter a new ID code, or continue by using the patient file in memory.

Press ◀ to confirm the code; press one of the arrow key to modify.

DATE OF BIRTH

Insert patient data with the numeric keys; *spirolab III* automatically calculates the patient age which is then shown in the space "AGE". Insert the other data using ◀.



HEIGHT

Enter the subject's height (in cm or in inches, according to the current configuration), using the numeric keyboard. Go to next entry using ◀.

WEIGHT

Enter the subject's weight (in Kg or Pounds, according to the current configuration), using the numeric keyboard. Go to next entry using .

SEX

Select gender using the keyboard,  for male and  for female.

ETHNIC GROUP

A list of possible ethnic groups appear, enter the number corresponding to the required ethnical group. Press 0 for no conversion factor.

By matching a subject to an ethnic group, the predicted values for that subject are then modified by a percentage determined by the ERS and published in: THE EUROPEAN RESPIRATORY JOURNAL Volume 6, Supplement 16 March 1993, Standardized Lung Function Testing § 5.3.



WARNING

By entering the number 0 (zero), no ethnic correction will be made to the calculation of the predicted values. It is possible to enter ethnic group no. 10, and to define a correction percentage of the predicted values between 50% and 200% of the predicted values in use.

WARNING

Note the settings pre-defined within the configuration menu when inserting patient data, in particular re date format, weight and height.



2.5.8 Modify subject data

To modify subject data press  and then .
All data not to be modified must be confirmed by pressing .

2.6 SPIROMETRY: FVC, VC/IVC, MVV

All subject data must be entered before carrying out a spirometry test.
The test can be made from the main screen or from any display that shows a previous test result (last test, best test or test in memory).

Select the spirometry test:

-  To make the **FVC** test
-  To make the **VC/IVC** and ventilatory profile tests



To make the **MVV** test.

When a test is being performed the display will show the real time Flow/Volume curve or the Volume/time curve (if the pediatric incentive is set, then the volume/time curve is displayed.). The test must begin within 30 seconds of pressing the start key, otherwise the test is interrupted and the device returns to the main screen.

2.6.1 Spirometry testing

Insert a new mouthpiece into the MiniFlowMeter mouthpiece holder.

Fit the nose clip onto the nose of the subject, to ensure that air cannot escape through the nostrils.

The subject must insert the mouthpiece well into the mouth, it should be inserted at least 2 cm beyond the front teeth and held between the teeth, closing the lips to ensure that air cannot escape from the sides of the mouth.

Breathe as directed according to the test to be undertaken, details follow.

Make the test in either a standing or a sitting position. During total expiration (slowly or forced) lean forward to help the expiratory action with a compression of the abdomen.

FVC

If required (this part is optional), before the test make several breaths at rest. When ready, inspire slowly as much air as possible (opening the arms helps) and then expire all of the air as fast as possible. Then, without removing the mouthpiece from the mouth, finish the test by inspiring again as fast and as completely as possible.

This final inspiration is not necessary in the case that the inspiratory parameters (FIVC, FIV1, FIV1%, PIF) are not required.

The cycle can be repeated several times, without removing the mouthpiece, in which case **SpirolabIII** will automatically select and show the best test and measured parameters. To



end test press  or just wait for 3 seconds after the last volume cycle, the test terminates automatically.

WARNING

In the case of an FVC test, after making at least two valid tests, the reproducibility of the parameters FVC, FEV1, and PEF is also shown.

VC/IVC and Ventilatory Profile tests

It is possible (optional) to begin the test by making several complete breaths at rest. After three or four similar breaths, a message (VC/IVC) on the display will indicate that the ventilatory profile has been measured and you can now proceed to carry out the VC or IVC test.

VC test: When the message VC/IVC appears, inspire slowly as much air as possible into the lungs and then expire slowly as much air as possible.

IVC test: When the message VC/IVC appears, expire slowly as much air as possible and then inspire slowly as much air as possible.

To end the test press  or wait 3 seconds after the last volume cycle.

If you make the test without the ventilatory profile (respiratory function at rest) then the measured parameter will be only VC or IVC. Instead, by carrying out several complete breaths at rest, then in addition all measured parameters of the ventilatory profile will be given.

During the test the volume/time curve is displayed.

MVV

Start the test by carrying out a series of forced inspirations and expirations with the maximum possible amplitude. The suggested frequency is 30 breaths/min. The test will terminate automatically after 12 seconds.

To end test press  or wait 3 seconds after the last volume cycle.

At the end of any test, the related curves and the main measured parameters are shown. After viewing the curves, press  to view the remaining test parameters, plus the predicted values and the percentage ratio between the measured value and the predicted value.

During the test the volume/time curve is displayed.

2.6.2 Spirometry post - drug

WARNING

To carry out a POST test it is necessary to have carried out at least one PRE FVC type test on the patient on the same day; it is not possible to do a POST test on the PRE VC or MVV tests; it is however possible to do a POST VC or MVV test if the archive already contains at least one PRE test carried out on the same day.

1st case: current patient data

To perform a POST test on the current subject after completing e PRE test, follow these instructions:





Press  to activate the POST phase. On the bottom of display it is shown the following message:

ENTER to make POST test

It is possible to carry out the POST test using one of the three tests available. Selected the test, in the lower part of display it is possible to define the dose administer to the patient before the test; the value can be inserted with numeric keys.



2nd case: subject file

To perform a POST test on a patient already in memory, firstly “recall from memory” the relevant PRE test spirometry parameters from the same subject file.

Press ; select using one of the research methods the PRE file. Confirm with . Press  to set a new test with the same patient. Press  to activate the POST phase. When the POST phase is activated, the patient data are shown and “POST” appears under file number.

WARNING

In the POST phase the FVC, VC and MVV tests can be performed.

In the POST phase, having selected one of these three tests   or , the administered drug dose must be entered.

Whenever the test is repeated using the same dose, the best test related to the dose used is saved.

When the dose is changed, then a new record is made with a progressive FILE number. For example, if three tests are made on a subject at different doses, then three different records (POST tests) are saved for that subject.

Afterwards the separate best POST tests can be viewed.

The subject code in the POST test is the same as for the related PRE test.

The results allow the confrontation of the spirometry parameters calculated in the POST test against the best results obtained in the PRE test already present in the patient archive for that session* (*session refers to tests carried out on that day). It is not possible therefore to carry out a POST test on a patient if the patient archive only contains PRE tests carried out only on previous days.

When the results are displayed it is possible to see the variation between the PRE and POST values (shown in column headed CHG)

In the POST phase, the measured result is compared to the values of the related PRE test.

The Flow/Volume curves of the **PRE** test and related **POST** test are shown superimposed.



After the two curves, the measured parameters (POST), the related PRE values and the percentage variations between POST and PRE are also shown.











To make the results shown easier to understand a traffic light system has been used with the following icons ☺ and/or ☹ as per the criteria below:

- ☺☺ significant broncodilatation with FEV1 POST \geq 80% of predicted
- ☺☹ significant broncodilatation with FEV1 POST < 80% of predicted
- ☹☹ no significant broncodilatation

WARNING

In the POST phase no test interpretation is given, the test quality control messages are shown.

The POST test is available both in main display with the characteristics of the patient and in visualization of previous test (  or ) in this manner is easy to set post phase. Visualizing the data stored the active keys are:

-  ;
- #ID (for a new spirometric test with patient selected)
-  (for a POST test)
-  (print out of the selected test)
-   and   for display
-  to go to the archivi menu.
-  (key for generic stop)
- 1, 2, 3 (if there are made more than one test).

Physiological test (placebo)

It is common practise prior to a POST test to carry out a test using physiological solution in place of a drug, to examine the subject's response to such a stimulus.

If the subject is healthy then the reaction to a placebo is almost zero, but in the case of hypersensitivity even this stimulus can have some effect.

In the physiological test the amount of the dose to enter is zero and it is still possible to compare the POST results with those of the PRE test.

The POST phase will show a coloured string highlighting the words POST FILE No. and DOSE.

WARNING

The POST test can be based only on a PRE test made in the same day; it is not possible make a POST test referred to a PRE test made in the previous days.

WARNING

To end the POST phase and make new PRE tests, press  and then .

2.7 TEST QUALITY CONTROL - SPIROMETRY

Through a mathematical analysis (quality control) which is applied to certain calculated indices and parameters, the **spiroLab III** produces a series of comments, helpful for understanding the reliability of the test made.

ERROR IN Vext and PEFT

If the extrapolated volume Vext is greater than 500 mL or more than 5% of the FVC, or if the PEFT (time to peak flow) is greater than 200 ms, this message is shown:

Repeat test and blow faster

FLOW DROP 50%

If the flow rate falls (>50%) and then rises again during the 1st second of a forced expiry, this message is shown:

Repeat and avoid coughing

FET ERROR

If the FET is less than the minimum (3 seconds), this message is shown:

Expiry time insufficient

FLOW ERROR

If the last point of the F/V curve is greater than 200 mL/s, this indicates that the expiration was not complete and thus this message is shown:

Blow out all air in lungs

2.8 REPEATABILITY OF THE FVC TEST

Following the international **ATS** and **ERS** standards, it is recommended to repeat each **FVC** test at least 3 times to ensure the reliability of the spirometry test results. The device helps the user through the reproducibility control check.

Between tests, the **repeatability** of the following parameters is calculated:

PEF	repeatability when the difference between the two largest PEF is ≤ 0.67 L/s;
VC	repeatability when the difference between the two largest VC is ≤ 150 mL;

If FVC is > 1.0 L then:

FEV1	repeatability when the difference between the two largest FEV1 is ≤ 150 mL;
FVC	repeatability when the difference between the two largest FVC is ≤ 150 mL;

if FVC is ≤ 1.0 L then:

FEV1	repeatability when the difference between the two largest FEV1 is ≤ 100 mL;
FVC	repeatability when the difference between the two largest FVC is ≤ 100 mL;

2.9 METHOD OF MEASUREMENT AND INTERPRETATION

The device uses the infrared interruption principle of measurement, with two sets of optoelectronic transmitters and receivers. A pair of deflectors positioned at the entry and at the exit of the turbine tube generates a vortex in the passing air, around the axis of the sensor. A rotor with a speed of rotation directly proportional to the air flow then interrupts the infrared beams and generates a digital signal. The measurement of the air volume that passes through the tube is proportional to the interruption of the infrared rays. This measurement principle guarantees stability, reproducibility and reliability over a long period of time, and the measurement is not affected by gas density, humidity or pressure.

WARNING 

The measurement of the air volume that passes through the tube is proportional to the interruption of the infrared rays.

The cleaning of the turbine flow sensor is very simple, and is essential for the protection of the subject from possible infections. For cleaning operations see Chapter 4 of this Manual. No calibration of the turbine is required, but it is good practice to make a calibration check by following the simple instructions contained in the relevant paragraph in the maintenance section of this manual.

Method of test interpretation

Following each **FVC** test, the device carries out a quality control check to verify the acceptability of the test made and, if possible, compares the main measured parameters FEV1, FEV1% and FVC with the respective predicted values. It also calculates a series of indices, based on the following criteria:

$$\text{index \%} = \frac{\text{measured values}}{\text{predicted values}} \times 100$$

The interpretation of these indices %, according to the ATS standards, generates a series of messages which correspond to possible levels of obstruction or restriction plus one level of normal spirometry, as shown in the following table:

normal	→ green
mild	→ green-yellow
moderate	→ yellow
moderately severe	→ yellow-red
severe	→ red
very severe	→ violet

If it is not possible to make the calculations for lack of data, the interpretation is not valid and this message appears:

NOT VALID

WARNING 

The interpretation during a test session for each subject always refers to the best test results made by that subject.

2.10 OXIMETRY TESTING

spirolab III can carry out different types of oximetry tests, which are described in the following paragraphs.

WARNING

If *spirolab III* has been purchased without the oximetry option, then only spirometry tests can be made. If the oximetry option is purchased afterwards, then contact the service centre or the manufacturer to enable the function.
If during the oximetry testing the SpO₂ blood pulse rate goes below the lower threshold or goes over the upper threshold, *spirolab III* will 'beep' while this situation persists. This option can be switched off during sleep tests.
The values shown are the default settings.

WARNING

Note: the sensor described below is for illustration purposes only. *spirolab III* is enabled for the use of any of the sensors described in the previous Paragraph 1.2.4. MIR does not recommend the use of a specific type of sensor; this decision is made by the doctor.
During the oximetry test *spirolab III* cannot be switched off, to switch off the device it is necessary to interrupt the test in progress, this avoids unwanted interruptions which could compromise the accuracy of the data obtained.

For the non-invasive measurement of the SpO₂ oxygen saturation and blood pulse rate utilize the re-usable finger sensor. This sensor is recommended for patients weighing > 20 Kg with limited activity.

spirolab III memorises the two oximetry values every 2 or 4 seconds.

Carry out an oximetry test as follows:

- Connect the sensor to the instrument: insert the connector with the arrow (printed on the connector) face-up, as shown:
- Choose a high perfusion site, which is easily adaptable to the sensor.
- Insert finger into the sensor until the finger touches the end of the probe. Ensure that the bottom part of the finger completely covers the detector. If the finger is not able to be correctly positioned, use another finger.
- Position the sensor so that the cable is underneath the palm of the hand. This enables the light source to remain on the fingernail and the detector on the bottom part of the finger. From the main screen press  to access the test menu.
- Select required test using the vertical scroll arrow.



If this message appears:

OXIMETRY NOT DETECTED

then your instrument does not include an oximeter.

If this message appears:

OXIMETRY DISABLED

the function has not been enabled. In this case contact a service centre or the manufacturer.

WARNING 

Before starting the test check to see that the battery is fully charged, if it is low the following message will be shown:

Batteries are low and may not be sufficient for an oximetry test.

In this case select ESC to exit the test, by pressing any key you can continue with the test already set up.

If the test is interrupted, due to low battery charge, the following message will appear on the display when the device is switched on again:

The last oximetry test was interrupted before being properly completed

**A beeping sound will be simultaneously heard for 10 seconds.
After which the spirolab III main screen will appear.**

The oximetry tests that can be performed by **Spirolab III** are:

1. SPOT OXIMETRY
2. SLEEP OXIMETRY
3. EXERCISE OXIMETRY
4. SPOT OXIMETRY (MEMORIZED LIKE OXYTEST)

Choose required test pushing corresponding number on numeric key board.



During the test the display shows the informations like in the following image
The number of blocks shown next to the SpO2 value are proportional to the signal quality (maximum 8 blocks). Position the finger within the sensor in order to maximise the signal strength.

WARNING 

In order not to compromise the reproducibility of the measurements and the integrity of the sensor, avoid twisting the sensor cable and handle with due care when using, connecting, disconnecting and when placing the finger into it.

During the first few seconds of the test the device searches for the best signal, after which the timer re-sets to zero and **spirolab III** starts to memorise the data.
For each type of test, if the sensor has not been correctly inserted, after a few seconds the following message will appear:

Connect sensor

Contemporaneously **spirolab III** emits a beep for 10 seconds.
If the sensor has been inserted but the finger is not inserted correctly, the following message will appear:

Insert finger

Contemporaneously **spirolab III** emits a beep for 10 seconds.

If the sensor correctly receives the signal, after a few seconds the device starts to 'beep' and the values will be displayed on the screen.

For all oximetry tests alarms can be set up in the case that the critical values are exceeded as described in paragraph 2.5.5. In the case that the alarm is activated during the test, the



symbol on the display will be seen and this can be activated/disactivated by pressing



to disactivate, and



to activate.

For further information on the correct set up for this function please refer to paragraph 2.5.5.

2.10.1 Spot oximetry

WARNING

The sensor described below is for illustration purposes only spirolab III is enabled for the use of any of the sensors described in §1.2.4. MIR does not recommend the use of a specific type of sensor; any decision in made by the individual doctor.

To perform a non-invasive continuous monitoring of arterial oxygen saturation, it is recommended to use the reusable "wrap" sensor. The use of this sensor is indicated for patients weighing more than 30 Kg and contraindicated for patients with allergy to adhesive tape.

WARNING

The materials used for manufacturing the sensor are NATURAL LATEX PROTEIN free. The materials used for the sensor are subject to biocompatibility tests.

Adult Single Patient Sensor – Instructions for Use

WARNING

This sensor is contraindicated for use on patients who exhibit allergic reactions to the adhesive tape. Do not reuse. One use on one patient.

- Choose an application site on the patient's finger or toe where the light source will be directly over and in-line with the detector. The preferred sites are the forefinger or smaller thumb.

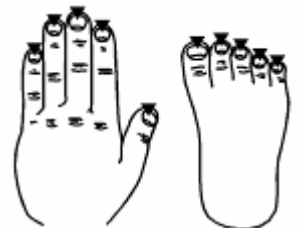

- Remove nail polish or artificial fingernails

- Place the patient's digit in the sensor nail-side up, lining up the digit's pad over the detector. The sensor's positioning line runs across the mid axis of the fingertip
- Wrap the bottom adhesive around the digit, being careful not to cover the nail.
- Fold the sensor's top over the digit, making sure the light source is directly over and in-line with the detector. Wrap the adhesive around the finger or toe to secure the sensor. Route the cable along the palm or the bottom of the foot, and secure with adhesive tape if necessary.

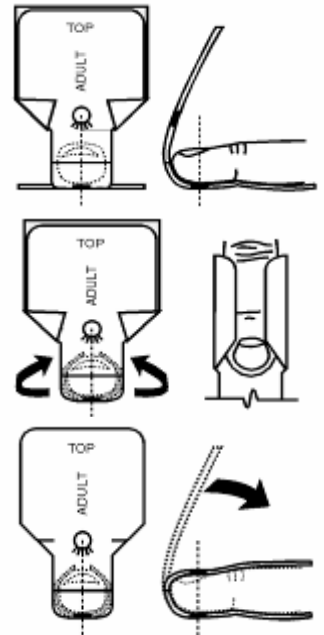

Connect the sensor to the instrument: insert the connector with the arrow on the connector face-up and control the correct functioning according to the previous instructions.

WARNING 

Do not twist unnecessarily or use excessive force when using, connecting, disconnecting, or storing the sensor.
An over-tight sensor can produce inaccurate saturation measurements. Therefore avoid over tightening the adhesive tape.
It is recommended to fasten the cable to the wrist with a bandage.

Making a Test

Select "Oximetry (SpO₂/BPM)" from the oximetry tests list pressing 1 on the numeric key. The display shows: "Oximetry (SpO₂/BPM)". The test duration is unlimited and the aim is to record variations of the oximetry values during a period as decided by the doctor. If the finger is removed from the sensor during the test, the following message will appear:

Please, wait for signal

The data shown during the test are:

- Spo₂
- Quality of signal received
- BPM

- Test time extension
- Time curve of the two parameters (SpO2 and BPM)
- Test type in execution
- Possible warning message

To end test, press 

To print data see Paragraph 3.1.2; see example of the test printout report attached to this Manual.

2.10.2 Sleep Oximetry

To choose this test press 2 on numeric key.

This test records the variations in the patient's parameters overnight.

After approximately 5 minutes **spirolab III** will go to standby i.e., it stops beeping and the display turns off. The led signal remains on. To control the correct functioning while on

standby, press , after 5 minutes **spirolab III** will automatically return to standby. If there is no signal while on standby the device will automatically exit this phase and a warning message will appear (sensor unplugged or finger not detected correctly).

The data shown are the same as described in the preceding test, except for information on this present phase, which is not envisaged for this test.

The data shown are the same described previously.

After the required time the test can be interrupted as previously described.

Results can be printed as described in Paragraphs 2.13 and 3.1.2; see example of the test printout report attached to this Manual.

2.10.3 Exercise oximetry

This test is made up of 3 phases:

- Baseline (initial rest)
- Exercise
- Recovery

Baseline (initial rest)

The data shown are the same described previously.

The duration of the test is minimum 2 minutes, then this message appears:

pass to EXERCISE phase

press 1 to pass to the following phase. If the phase lasts for more than 6 minutes then **spirolab III** will emit a 'beep' as a reminder to pass to the exercise phase.

Exercise Phase

At the beginning of this phase the timer is reset to zero, to give an accurate control of the duration of each single phase. The data on the display is the same as shown before.

The duration of this phase is minimum 2 minutes, this message will appear:

pass to RECOVERY phase

press 2 for a few seconds to pass to the recovery phase. If this phase lasts for more than 6 minutes then **spirolab III** will emit a 'beep' after which the device passes to the initial phase and the timer is re-set to zero.

Recovery Phase

The user can decide freely on the duration of this phase, the duration is not suggested (at the beginning of the phase the timer re-sets to zero).

To end test press .





At the end of the test the data required for the calculation of the parameters must be inserted; more specifically:

- Baseline DYS-PNEA
- Final DYS-PNEA
- Baseline FATIGUE
- Final FATIGUE

These follow the Borg scale and can have the following values: 0, 0.5, 1, 2, 3, 4, 5, 6, 7, 8, 9, 10.

The Borg scale coefficients represent the following severity values:



SCALE	SEVERITY
0	None
0.5	Very Very Slight (Just Noticeable)
1	Very Slight
2	Slight
3	Moderate
4	Some What Severe
5	Severe
6	"
7	Very Severe
8	"
9	Very Very Severe (Almost Maximum)
10	Maximum

Use  and  to enter data; use  or  to go back or pass to next data.

Exercise test data results are given in the following screen, and can be printed as described in Paragraphs 2.13 and 3.1.2. if the test results are printed, the test printout will only show the exercise test results; an example of a test printout report is attached.

Press  to end the test at any moment.

At the end of the test are shown calculated and inserted data with more than one display.

Use  or  to read the various data.

WARNING 

One of the parameters calculated by the Spirolab III during an oximetry test is the so-called Recovery Time. The Recovery Time is defined as the time taken for the

SpO2 value to return to at least 99% of the average base value calculated during the initial phase of the test.

2.10.4 Spot oximetry (MEMORIZED LIKE OXYTEST)

This test is the same described in 2.10.1; the only difference is that the test is without subject data; in the archive the test is memorized with the name: "OXYTEST". The parameters calculated are like in spot oximetry (see 2.10.1).

2.11 FILE ORGANIZATION

The memory of the spirometer is a 'string' of memory areas called records, each of which contain information regarding a single test session.



More specifically, each record is made up as follows:

- Demographic details of the subject
- Date, time and ambient temperature at the time of the **FVC** test
- Reproducibility and quality control test information
- Parameters stored with the **FVC** test:
 - FVC, FEV1, PEF, FEF75, FEF2575, FET, *PEF, *FVC, *FEV1, FEV1%, FEV6, FEV6%, FEV3, FEV3%, FEV1/FEV6%, FEF25, FEF50, Vext, FIVC, FIV1, FIV1%, PIF, FEV1/VC
- Parameters stored with the **VC** test:
 - VC, IVC, EVC,* (EVC or IVC), ERV, IC, TV, VE, fr, ti, te, TV/ti, te/tt
- Parameters stored with the **MVV** test:
 - MVV
- Points of the expiratory part and (if present) the inspiratory part of the Flow/Volume curves, plus the points of the Volume/time curve.
- Parameters stored with the SpO2 test (in relation with the test recorded, see also paragraph 1.6.2):

WARNING

All of the parameters are always stored even if not all of the tests were performed (in this case the results of those parameters are stored as zero). The symbol * indicates the best result of that subject.

Spirometry results can be recalled from the memory.

To access the database, press . The results of the selected test can be printed by pressing  after visualization on display.

2.12 SEARCH AND READ TESTS IN MEMORY



Press to access menu, from where to view all test data stored in the memory of the device.

The research can be made in three different manners:

- Subject list by last name
- Subject list by ID code
- List by date
- Memory list

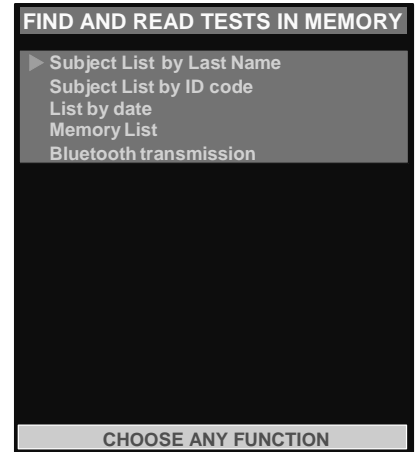

Using and , select the method with , then press .

From this display it is also possible make the archive transmission with Bluetooth connection, using a cell phone (please see paragraph 3.1).

2.12.1 Subject List by last name:

This message appears:

**INSERT LAST NAME OR THE FIRST
LETTERS OF LAST NAME TO FIND
ALL MATCHING FILES IN MEMORY**

Use keyboard to enter subject surname or first letters. All corresponding surnames found in memory will then be listed.

The first column on the right will show the file numbers corresponding to the tests made, use numeric keyboard to enter required test, press to view related values.

Print selected test results, using the internal printer, by pressing , pressing twice the data are print on the external printer via Bluetooth system.

2.12.2 Subject List by ID code

The following message appears:

**ENTER ID# CODE,
OR PARTIAL TO SEARCH
MATCHING FILES**

Enter subject ID# and press to view the list containing all file linked with the patient.

The data can be printed like described previously.

2.12.3 Memory List

The screen will show the complete test memory list. Indicate FILE No. to view corresponding spirometry test results and press .

The data can be printed like described previously. The data shown can be printed individually or in group; it is possible to print a sequence of tests (pressing the keys of the first and the last) otherwise a single test pressing the number on numeric keys, then press .

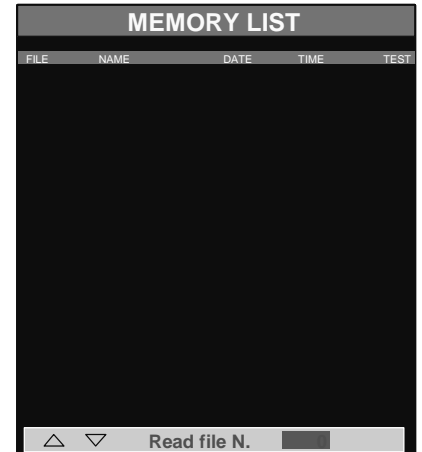

2.13 VIEW AND PRINT RESULTS

WARNING

During a test session the device will automatically memorize up to 8 FVC tests.

Press  to view the results arranged in 8 sections on the screen. Each of the 8 tests can be viewed and printed. These tests are numbered from 1 to 8, where test 1 represents the best test and 8 represents the worst test. The last test made is always highlighted in green.

During the test session press  (which recalls the best test), the device will always show the graphs and results of the 3 best tests. Each of the 3 tests can be viewed and printed.

At the end of the test session, when either a new subject is inserted or you pass to the POST phase, the 3 best tests corresponding to the previous session are automatically saved on file. These can be successively recalled from memory and viewed or printed either together or separately.

From the main screen it is possible to re-examine and to print all the spirometry parameters.



Generates the Flow/Volume curves of the best test.



Generates the Flow/Volume curves of the last test.

WARNING

All tests results saved on file can be recalled, viewed and printed.

The data stored in the memory are those of the best tests. The current test can be printed by

pressing . To print a test saved on file after recalling it press . To interrupt printing press .

The printout report includes a header line with the date, time, the BTPS value at the time of the test, patient details, the FILE No., any pre-set ethnic correction factor and the predicted value set used.

There follow the Flow/Volume and Volume/time curves, which relate to either the last or best test performed.

Press from the main screen to print the best test results of the day relative to the displayed patient.

To print the last test press while viewing the last test. Lastly, the measured parameters and spirometry test interpretation are shown. In the case of a PRE test, the following are shown:

Predicted	calculated predicted values
PRE	measured value before drug administration
%Predicted values	percentage value against predicted values

In the case of a POST test then the graph will show the two curves superimposed and in addition to the above-mentioned parameters, the following values:

POST	measured value after drug administration
%CHG	% variation (+/-) between POST and PRE.

From the measured parameter's screen (or key, or recalled from memory) the subject's name, date and time of test is shown on the bottom of the screen.

3 DATA TRANSMISSION

spirolab III includes a "Bluetooth" wireless data transmission system. This connection is via radio and allows the transferring of all the data in memory for two different operations:

- transfer to a cell phone, which then transmits the data to a PC by modem;
- transfer to a Bluetooth-enabled printer.

The following paragraphs contain in-depth information on these two procedures.

3.1 DATA TRANSMISSION VIA BLUETOOTH TO A CELL PHONE





spiroLab III can be connected to a cell phone with this system installed. The transmission of data with this technology allows the transfer of all data in memory of the **spiroLab III**. The sequence of operations to follow is described below.

3.1.1 Preliminary operations



WARNING

The transmission of data through a Bluetooth connection requires the phone number of the unit where the data shall be transferred (the doctor's office, telemedicine service, etc.). The phone number is set up from the Configuration Menu (see Paragraph 2.5.5). A device must also be setup for the connection; ; refer to Paragraph 2.5.5 for further details.

3.1.2 Setting the Phone Number

- With **spiroLab III** switched on, press .
- Use vertical scroll key to select "Bluetooth settings" then press .
- Use vertical scroll key to select "insert telephone number" then press .
- Enter the number with the numerical keyboard, and again press ; the Bluetooth Menu will appear.
- Use  to return to the main screen.

3.1.3 Data Transmission through Bluetooth

- From the main screen press .
- Use vertical scroll keys to select "Bluetooth transmission" and press .
- it is described the transmission way and, if correct, it is required to confirm it with "OK" to activate the connection to the device choosen as default in the configuration menu.
- when the request is from mobile phone, type the code shown on the screen (relative to the device's Serial Number reported on the back label of **spiroLab III**)
- are executed all the next connection steps.
- When the connection is active, data are transmitted from the selected modem
- At the end of the transfer data process the following message "Connection Completed" is shown.

The screen will show the following information:

- The device used for the connection;

- The pre-set phone number.
- The preset PIN (corresponding to the serial number of the device).

To interrupt data transmission during the Bluetooth connection press  to end the connection and to return to the main screen.

Where no device has been setup for data transmission, a message will appear on the display to start searching for enabled devices. After setting the device the connection will start up automatically.

3.1.4 Data Transmission via Bluetooth for printing

WARNING

Printing of data from the patient management function is enabled only if the printer has a Bluetooth connection; alternatively a USB key can be installed on the printer in order to enable a Bluetooth connection.

The Bluetooth system enables **spirolab III** to transfer test data directly to a printer with Bluetooth. The sequence of activities to be followed is:

- When the test is finished or searched in the archive press twice 
- **spirolab III** will carry out the phases of connection.
- At the end of the transmission **spirolab III** will show the message "CONNECTION COMPLETED", returning automatically to the main screen

Previous tests stored on file can also be printed. Use the procedure described in Paragraph 2.11 to print required tests. When the required test is shown on the display, press twice



To interrupt data transmission during Bluetooth connection press  to end the connection and to return to the main screen.

Where no printer has been set up, a message will appear to search for devices. After the device has been set up it will automatically be enabled for printing.

When searching for Bluetooth enabled devices, **spirolab III** will check the address of that device and where a previously registered device has changed name, it will be automatically updated.

3.2 CONNECTION TO A PC

spirolab III can be connected to a PC and perform tests online. Two connection types are used: USB port or RS 232 port.

3.2.1 Connection to a PC through a USB port

WARNING

Before connecting *spirolab III* to a PC via the USB port, the winspiroPRO software must be installed to interface with the device. Prior to initiating the following procedure it is important to know the version of the operating system on the PC (from Control Panel click on “System”, and here the operating system installed on the PC can be checked).

To make the connection insert the mini USB connector supplied with *spirolab III* as shown in the picture and attach the other connector to the USB port of the PC.

When initially making a connection, the PC will, depending on the version of the operating system, either make an automatic driver installation or request some information. To avoid errors in this phase please read the winspiroPRO User Manual very carefully.



3.2.2 Connection to PC through RS 232 port.

spirolab III can be connected to a PC through a RS 232 serial port. This leaves the USB port free. The picture shows the RS 232 connector attached to *spirolab III*.

For the correct management of the device see the software manual.

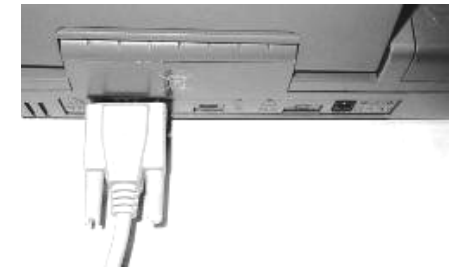

3.3 UPGRADE INTERNAL SOFTWARE

spirolab III can be upgraded when connected to a PC (via USB or RS232). Upgrades can be downloaded by registering on www.spirometry.com. For further information on upgrading software see the “winspiroPRO” software manual.

4 MAINTENANCE AND CLEANING

spirolab III is an instrument that requires very limited maintenance. The operations to perform periodically are:

- Cleaning and controlling of the reusable turbine.
- Changing the disposable turbine at each test.

- Cleaning of the oximetry sensor (for reusable sensors).
- Changing the adhesive tape of the oximetry wrap sensor.
- Changing the battery.

The maintenance operations described in the User's Manual must be carried out carefully. Failing to observe the instructions may cause errors in measurement or in the interpretation of measured values.

Modifications, adjustments, repairs, and reconfiguration must be carried out by the manufacturer or by authorised persons.

In case problems arise, never attempt to repair the unit.

The setting of the configuration parameters must be carried out by qualified personnel. In any case, the risks from an incorrect setting do not constitute a danger for the patient.

The device is supplied with an internal lithium battery used to back-up the RAM; the average battery life is approximately 10 years. If this message appears:

WARNING ! Replace the internal lithium battery

Contact a service centre or the manufacturer for battery replacement.

4.1 CLEANING THE DEVICE

Clean the device with a damp cloth. Make sure to dry it afterwards.

WARNING 

**Do not wet or immerse the device or power supply in any liquids.
Do not use any abrasive materials to clean the device.**

4.2 CLEANING THE REUSABLE TURBINE

The turbine utilized with **spiroLab III** is of one of two categories: disposable or reusable. These guarantee precise measurements and have the advantage of requiring no periodic calibration. In order to maintain these characteristics, a simple cleaning is required prior to each use (**only for the reusable turbine**).

Cleaning of the disposable turbine is not required as it is supplied already clean in a sealed plastic bag. It must be disposed of after use.

The maintenance operations to perform are cleaning and controlling of the turbine.

WARNING ⚠

It is good practice to control from time to time that dirt or foreign bodies such as threads or hair are not deposited inside the turbine. Any such deposit could brake or block the blade of the turbine and thus compromise the measurement accuracy.

To clean the **reusable** turbine, remove it from its compartment in the MiniFlowmeter by turning it anti-clockwise and pressing lightly. It can be helpful to push it gently from underneath with one finger.

Immerse the turbine in a cold detergent solution and move it within the liquid to remove any impurities which may be deposited inside. Leave the turbine immersed for the time specified in the instructions of the solution.

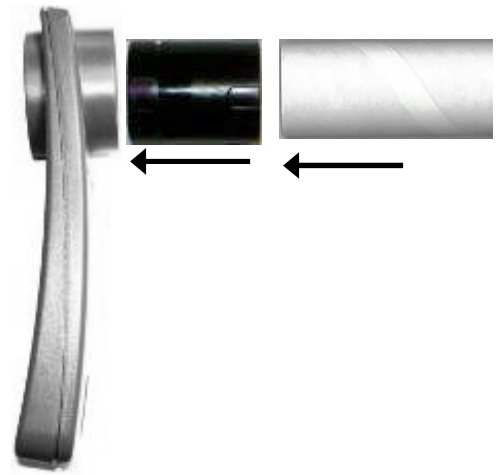

Miniflowmeter Turbine Mouthpiece

WARNING ⚠

To avoid causing irreparable damage, never clean the turbine by placing it under a direct jet of water or any other liquid. Where no cleaning solutions are available, it is indispensable to clean the turbine in clean water. Do not sterilize in an autoclave. This operation would cause irreparable damage to the turbine.

Rinse the turbine by immersing it in clean water (**not hot**).

Shake off the excess water from the turbine and leave it to dry, standing it vertically on a dry surface.

To ensure that the turbine is functioning correctly before replacing it inside the instrument it is good practice to make a visual check of the rotation blade. Placing the turbine tube horizontally and moving it gently from left to right and vice versa, the rotation blade (rotor) must rotate freely. Otherwise, accurate measurement is no longer guaranteed, so the turbine must be replaced.

Once the turbine has been cleaned, insert the turbine tube in its place following the instructions indicated by the "lock " symbol printed on the MiniFlowmeter.

To insert the turbine correctly, push it and then turn it clockwise until reaching the stop, which ensures that the tube has been blocked inside the casing.

Verify the free movement of the turbine:

- Switch on **spirolab III** as if to make a spirometry test (for example **FVC**).

- Hold the MiniFlowmeter in one hand and move it gently from side to side, so that air passes through the turbine.
- If the rotor within the turbine is turning correctly, then you will hear a beep that indicates that the turbine is moving within the specific low flow range.
- If moving the turbine from side to side at a constant velocity, regular *beeps* or no beeps at all are heard, then proceed with the cleaning of the turbine.

WARNING 

If the disposable turbine is used, do not clean it but replace it after each test. To avoid environmental contamination caused by the disposal of the cleaning solutions, the user must follow all local regulations.

4.3 CLEANING AND DISINFECTION OF THE OXIMETRY SENSOR

WARNING 

Do not sterilize by irradiation, steam, or, ethylene oxide. Do not immerse in liquids. Before cleaning or disinfecting the sensor, unplug it from the monitor.

CAUTION 

Before cleaning or disinfecting the sensor, unplug it from the device

Clean the sensor with a soft cloth moistened with water or a mild soap solution. To disinfect the sensor, rub with isopropyl alcohol. Allow the sensor to dry completely after cleaning.

5 PROBLEMS/CAUSES AND SOLUTIONS

The device does not switch on

Press firmly on the **on** key.

The internal battery may be discharged.

Make sure that the power supply cable of the charging unit is connected to the spirometer and that the plug is inserted correctly into the mains outlet, then proceed with charging.

The LCD does not display

Using the two keys which regulate the brightness and the contrast of the display.

The battery charging is not working correctly

The device is protected thermally. In case the power supply of the battery reaching a high temperature then a thermal protection intervenes and prevents the charging.

This thermo protector can intervene if:

- the device has operated beyond the functioning limits indicated in this manual;
- the device is operated near a heat source, or in ambients with a temperature either too high or too low.

Disconnect the power supply and let it cool down before continuing with charging.

The lithium battery for the data memory indicates discharged

If the internal lithium battery is discharged, the spirometry parameters in the memory and other configuration data may be cancelled automatically.

Contact an authorized service centre to replace it.

The printer does not print

The thermal paper may have run out, otherwise may be inserted in the wrong way.

Check the correct position of the thermal paper, if necessary insert a new roll of thermal paper.

The printer is in thermal protection

The printer is also protected thermally. In case the printer reaches elevated temperatures then a thermal protection intervenes and blocks the functioning of the printer.

A message on the display appears to signal the protection.

Let the printer cool down before turning on the device again.

The printer makes noises

Make sure there is a sufficient quantity of thermal paper.

Make sure that the thermal paper and the thermal paper holder are positioned correctly.

Make sure that the thermal paper container lid is in the correct position.

The device does not measure

Make sure that the turbine's cable is connected to the spirometer and that the plug is inserted properly in the appropriate connector.
Make sure that the turbine is inserted correctly into the MiniFlowmeter.

The device does not measure correctly
Make sure the turbine is inserted correctly in the MiniFlowmeter. Verify the free movement of the turbine as illustrated in Paragraph 4.2.

WARNING 

In case the device does not resume correct functioning in spite of the controls made, contact the manufacturer or an authorized service centre.

WARNING 

Before contacting the centre for technical assistance, please download the archive from the device on to the PC using the Winspiro PRO software. This procedure is necessary as the data could be lost whilst repairing the device and could also be of a confidential nature and therefore subject to laws on data privacy.

5 LIMITED WARRANTY CONDITIONS

This MIR product together with its standard accessories is guaranteed for a period of ONE YEAR from the date of purchase. In the case of any warranty claims the relevant sales invoice (or another proof of purchase document) must be submitted to MIR.

The instrument must be checked at the time of purchase, or upon delivery, and any claims must be made within 8 days in writing to the manufacturer.

This warranty covers the repair or the replacement (at the discretion of the manufacturer) of the product or of the defective parts without charge for the parts or for the labour.

All batteries and other consumable parts are specifically excluded from the terms of this guarantee.

The instrument must be returned to the authorized service centre for repair within 8 days from when the defect is detected.

This warranty is not valid, at the discretion of the manufacturer, in the following cases:

- If the fault is due to an improper installation or operation of the machine, or if the installation does not conform to the current safety norms in the country of installation.
- If the product is utilized differently from the use described in the User's Manual (improper, incorrect and/or unreasonable use, etc.).
- If any alteration, adjustment, modification or repair has been carried out by personnel not authorised by MIR or by the user.
- If the fault is caused by lack of or incorrect routine maintenance of the machine.
- If the machine has been dropped, damaged or subjected to physical or electrical stress.
- If the fault is caused by the mains or by another product to which the instrument has been connected.
- If the serial number of the instrument is missing, tampered with and/or not clearly legible.

This warranty does not cover any liability for damage, caused directly or indirectly, of any kind whatsoever for persons or things for the period in which the device is not in use.

The repair or replacement described in this warranty is supplied for goods returned at the customers' expense to our certified service centres. For details of these centres please contact your local supplier of the spirometer or contact the manufacturer directly.

The customer is liable for all repairs not included under the terms of this guarantee. The customer is responsible for all transportation charges.

Any instrument or accessory returned must be accompanied by a clear and detailed explanation of the defect or problem found. If units are to be returned to the manufacturer then written or verbal permission must be received before any instruments are returned to MIR.

MIR - Medical International Research reserves the right to modify the instrument if required, and a description of any modification made will be sent along with the returned goods.

ANNEXES

DECLARATION OF CONFORMITY



MEDICAL INTERNATIONAL RESEARCH
Via del Maggiolino, 125 00155 - Roma - ITALIA

Declaration of EC Conformity

Quality Management System according to the requirements of Annex II of the Medical Device Directive 93/42/EEC.

Notified body CERMET N° 0476 - Certificate of Conformity N° MED - 9826

MIR srl Medical International Research declares that the Device subject of this declaration together with its standard accessories conforms to the requirements of the Council Directive 93/42/EEC Annex I.

Device Description

Device name

Classification

This device is marked with

Spirometer

spirolab III

Ila

CE0476

Any modifications to the Device which are not authorised by us will invalidate this declaration.

Roma 01/09 / 2006

Signature:

A handwritten signature in black ink, appearing to read 'Simon Fowler'.

Simon Fowler
Sales Manager

Signature:

A handwritten signature in black ink, appearing to read 'Carmine Cerullo'.

Carmine Cerullo
Quality Manager

EXAMPLE OF OXIMETRY TEST REPORT

Oximetry - Sleep Test

DATE 24/08/06 TIME 16:10 Ver 0.5
 NAME Kkk1 Iou
 BIRTH DATE 01/05/1975 #ID 2
 AGE 31 HEIGHT cm 180 SEX M WEIGHT Kg 78

SpO2 Graph

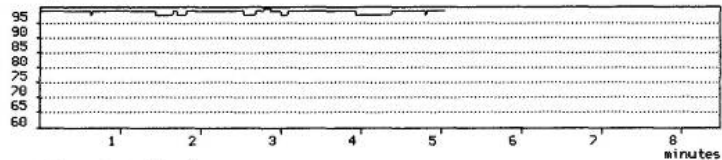

Pulse Rate Graph

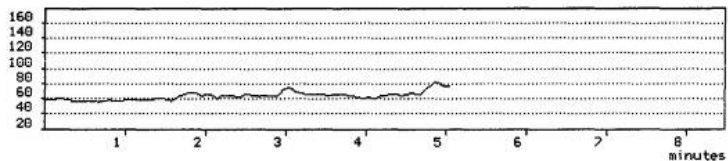

Recording Time 00:05:00 Analysis Time 00:04:58

%SpO2				BPM			
Baseline	97.8	Mean	97.7	Baseline	62.1	Mean	64.2
Minimum	97	Maximum	99	Minimum	56	Maximum	82

N. SpO2 Events <89%	0	N. Bradycardia Events < 40 BPM	0
Delta Index (12 sec)	.3	N. Tachycardia Events >120 BPM	0

T90 (SpO2 <90%)	% time	hh:mm:ss	T < 40 BPM	% time	hh:mm:ss
T89 (SpO2 <89%)	0%	00:00:00	T >120 BPM	0%	00:00:00
T88 (SpO2 <88%)	0%	00:00:00			
T87 (SpO2 <87%)	0%	00:00:00			

Total Desaturation Events	0	Total Pulse Rate Variations	1
ODI (Desaturation Index)	0	Pulse Rate Variation Index	12.0
Desaturation Peak (Nadir) (%)	99	Mean Duration Desat. (s)	0
Mean Desaturation (%)	0	Longest Duration Desat. (s)	0
Mean Drop SpO2 (%)	0	NOD 4 (Delta SpO2 >=4%)	00:00:00
Max Drop SpO2 (%)	0	NOD 89 (<89%)	00:00:00
		NOD 90 (<90%; Nadir<86%)	00:00:00

Made by spirolab III Signature _____

INFORMATION FOR CORRECT USE IN AN ELECTROMAGNETIC ENVIRONMENT

Guidance and manufacturer's declaration – electromagnetic emissions		
<p>The spiroLab III is intended for use in the electromagnetic environment specified below. The customer or the user of the spiroLab III should assure that it is used in such an environment.</p>		
Emissions test	Compliance	Electromagnetic environment – guidance
RF emissions CISPR 11	Group 2	The spiroLab III must emit electromagnetic energy to perform its intended function. Nearby electronic equipment can be affected.
RF emissions CISPR 11	Class B	The spiroLab III is suitable for use in all establishments, including domestic establishments and those directly connected to the public low-voltage power supply network that supplies buildings used for domestic purposes.
Harmonic emissions IEC 61000-3-2	Class D	
Voltage fluctuations/ flicker emissions IEC 61000-3-3	Complies	

Guidance and manufacturer's declaration – electromagnetic immunity			
The spiroLab III is intended for use in the electromagnetic environment specified below. The customer or the user of the spiroLab III should assure that it is used in such an environment.			
Immunity test	IEC 60601 test level	Compliance level	Electromagnetic environment – guidance
Electrostatic discharge (ESD) IEC 61000-4-2	± 6 kV contact ± 8 kV air	± 6 kV contact ± 8 kV air	Floors should be wood, concrete or ceramic tile. If floors are covered with synthetic material, the relative humidity should be at least 30 %.
Electrical fast transient/burst IEC 61000-4-4	±1 kV for input/output lines	±1 kV for input/output lines	Mains power quality should be that of a typical commercial or hospital environment.
Surge IEC 61000-4-5	± 1 kV differential mode ± 2 kV common mode	±1 kV differential mode ± 2 kV common mode	Mains power quality should be that of a typical commercial or hospital environment.
Voltage dips, short interruptions and voltage variations on power supply input lines IEC 61000-4-11	<5 % <i>UT</i> (>95 % dip in <i>UT</i>) for 0,5 cycle 40 % <i>UT</i> (60 % dip in <i>UT</i>) for 5 cycles 70 % <i>UT</i> (30 % dip in <i>UT</i>) for 25 cycles	<5 % <i>UT</i> (>95 % dip in <i>UT</i>) for 0,5 cycle 40 % <i>UT</i> (60 % dip in <i>UT</i>) for 5 cycles 70 % <i>UT</i> (30 % dip in <i>UT</i>) for 25 cycles <5 % <i>UT</i> (>95 % dip in <i>UT</i>) for 5 sec	

	<5 % <i>UT</i> (>95 % dip in <i>UT</i>) for 5 sec		
Power frequency (50/60 Hz) magnetic field IEC 61000-4-8	3 A/m	3 A/m	Power frequency magnetic fields should be at levels characteristic of a typical location in a typical commercial or hospital environment.
NOTE <i>UT</i> is the a.c. mains voltage prior to application of the test level.			

Guidance and manufacturer's declaration – electromagnetic immunity

The **spirolab III** is intended for use in the electromagnetic environment specified below. The customer or the user of the **spirolab III** should assure that it is used in such an environment.

Immunity test	IEC 60601 test level	Compliance level	Electromagnetic environment – guidance
<p>Conducted RF IEC 61000-4-6</p> <p>Radiated RF IEC 61000-4-3</p>	<p>3 Vrms 150 kHz to 80 MHz</p> <p>3 V/m 80 MHz to 2,5 GHz</p>	<p>[3] V</p> <p>[3] V/m</p>	<p>Portable and mobile RF communications equipment should be used no closer to any part of the spirolab III, including cables, than the recommended separation distance calculated from the equation applicable to the frequency of the transmitter.</p> <p>Recommended separation distance</p> $d = \left[\frac{3.5}{3} \right] \sqrt{P}$ $d = \left[\frac{3.5}{3} \right] \sqrt{P} \text{ 80 MHz to 800 GHz}$ $d = \left[\frac{7}{3} \right] \sqrt{P} \text{ 800 MHz to 2,5 GHz}$ <p>where P is the maximum output power rating of the transmitter in watts (W) according to the transmitter manufacturer and d is the recommended separation distance in metres (m).</p> <p>Field strengths from fixed RF</p>

			<p>transmitters, as determined by an electromagnetic site survey, should be less than the compliance level in each frequency range.^b</p> <p>Interference may occur in the vicinity of equipment marked with the following symbol:</p> 
<p>NOTE 1 At 80 MHz and 800 MHz, the higher frequency range applies.</p>			
<p>NOTE 2 These guidelines may not apply in all situations. Electromagnetic propagation is affected by absorption and reflection from structures, objects and people.</p>			
<p>a Field strengths from fixed transmitters, such as base stations for radio (cellular/cordless) telephones and land mobile radios, amateur radio, AM and FM radio broadcast and TV broadcast cannot be predicted theoretically with accuracy. To assess the electromagnetic environment due to fixed RF transmitters, an electromagnetic site survey should be considered. If the measured field strength in the location in which the spirolab III is used exceeds the applicable RF compliance level above, the spirolab III should be observed to verify normal operation. If abnormal performance is observed, additional measures may be necessary, such as reorienting or relocating the spirolab III.</p>			
<p>b Over the frequency range 150 kHz to 80 MHz, field strengths should be less than [3] V/m.</p>			

Recommended separation distances between portable and mobile RF communications equipment and the Spirolab III			
The spirolab III is intended for use in an electromagnetic environment in which radiated RF disturbances are controlled. The customer or the user of the spirolab III can help prevent electromagnetic interference by maintaining a minimum distance between portable and mobile RF communications equipment (transmitters) and the spirolab III as recommended below, according to the maximum output power of the communications equipment.			
Rated maximum output power of transmitter W	Separation distance according to frequency of transmitter m		
	150 kHz to 80 MHz $d = \frac{3.5}{V_1} \sqrt{P}$	80 MHz to 800 MHz $d = \frac{3.5}{E_1} \sqrt{P}$	800 MHz to 2,5 GHz $d = \frac{7}{E_1} \sqrt{P}$
0.01	0.12	0.24	0.24
0.1	0.37	0.37	0.74
1	1.17	1.17	2.34
10	5.28	5.28	1.056
100	11.66	11.66	23.32
For transmitters rated at a maximum output power not listed above, the recommended separation distance d in metres (m) can be estimated using the equation applicable to the frequency of the transmitter, where P is the maximum output power rating of the transmitter in watts (W) according to the transmitter manufacturer.			
NOTE 1 At 80 MHz and 800 MHz, the separation distance for the higher frequency range applies.			
NOTE 2 These guidelines may not apply in all situations. Electromagnetic propagation is affected by absorption and reflection from structures, objects and people.			