

8400ST[®] & 8400ST^{®i} VOLUME VENTILATOR SERVICE MANUAL

NOTE: The 8400ST[®] name is referred to throughout the contents of this manual. This information also applies to the 8400ST^{®i}. Specific information pertaining only to the 8400ST^{®i} is located in the back of the manual under Addendums.

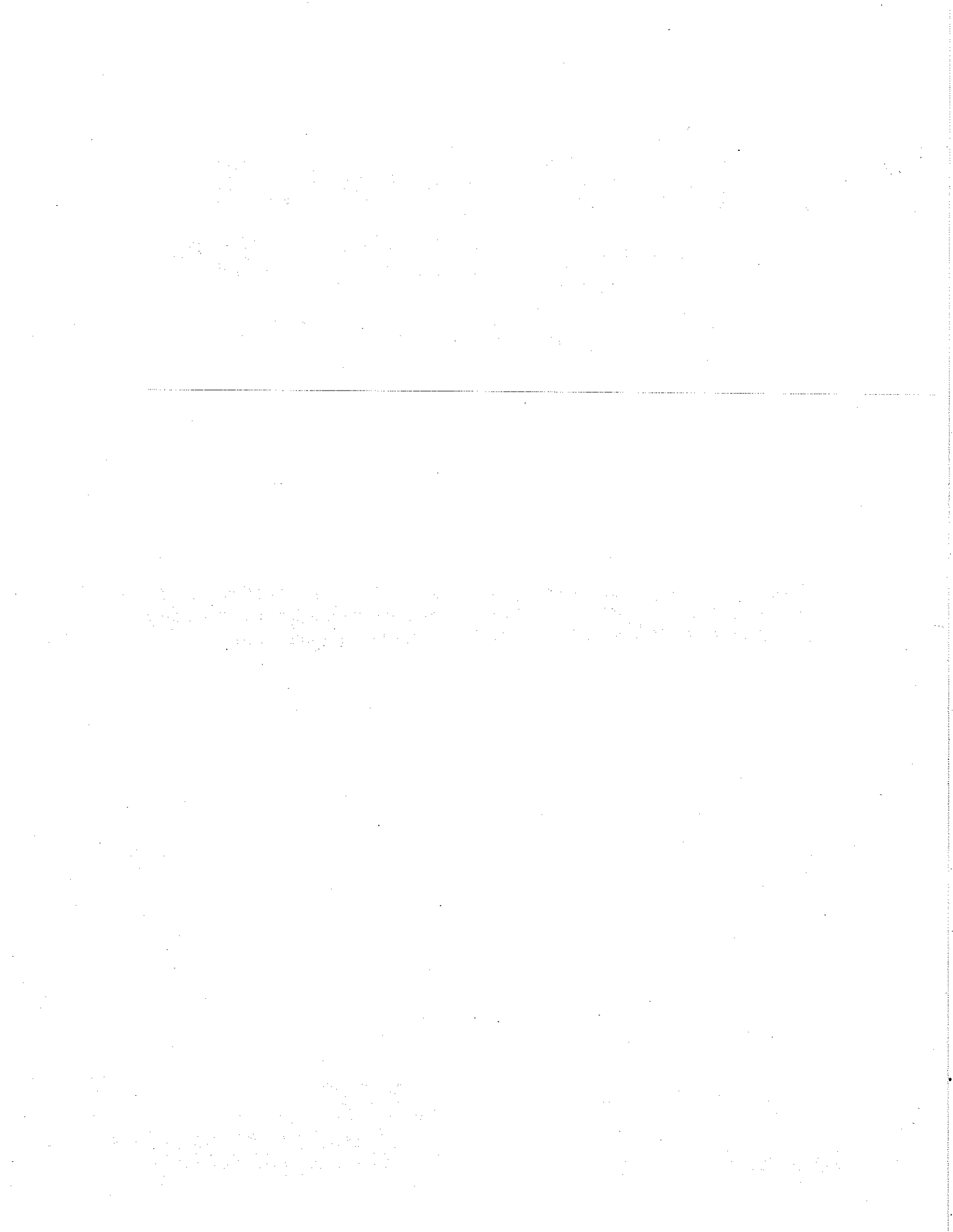

Bird Products Corporation
1100 Bird Center Drive, Palm Springs, CA 92262
(619) 778-7200 ■ TLX: 9103805605
(800) 328-4139 ■ FAX: (619) 778-7269



Bird Products
Corporation

MANUAL REVISION

8400ST/8400STi
Service Manual

Date	Revision	Pages
March 1998	Rev. D	

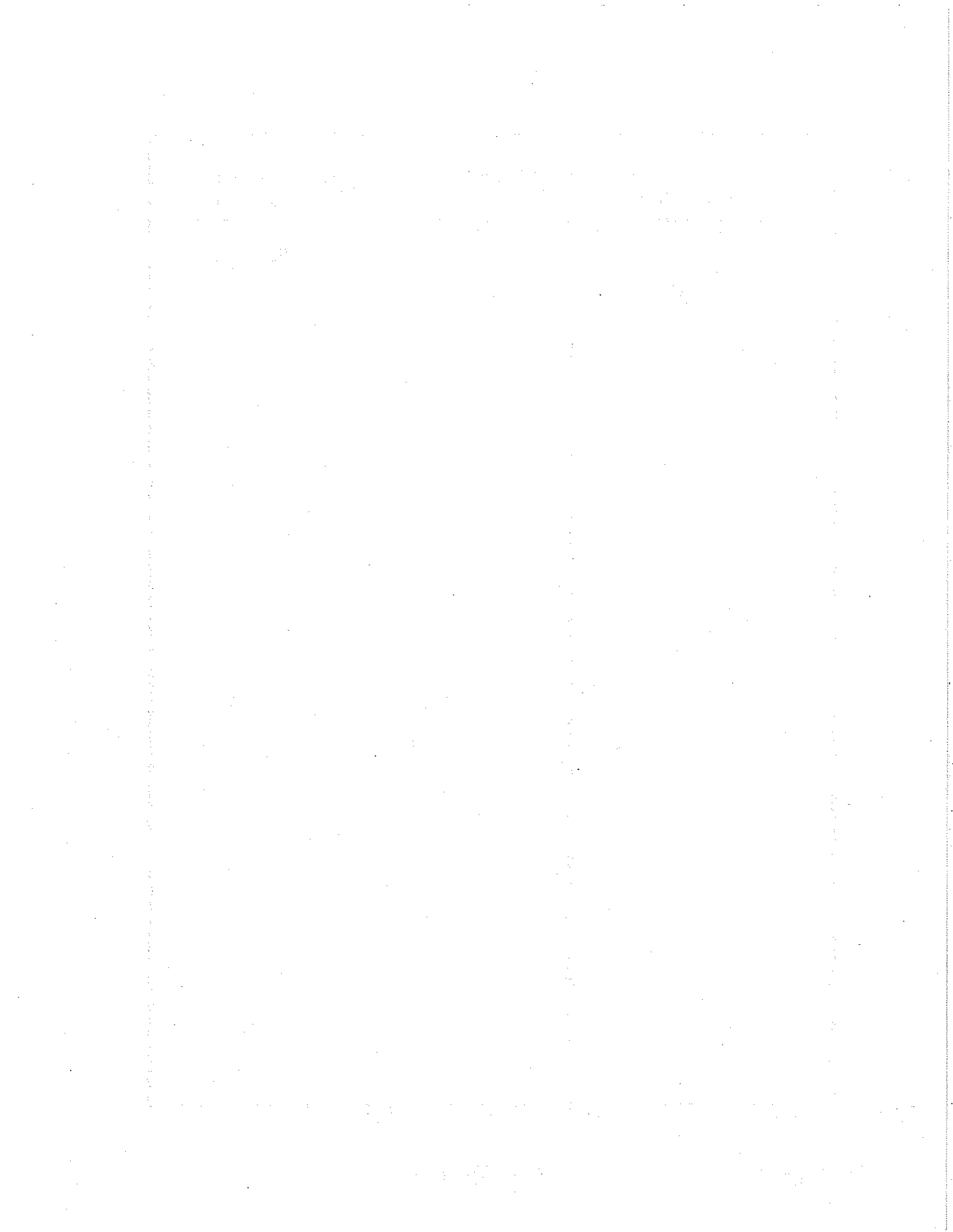

WARNING !

This service manual is intended for use by Bird Products Corporation trained and authorized service personnel. Bird Products Corporation does not condone or approve of service activity on its products by other than Bird Products Corporation trained or authorized personnel. **BIRD PRODUCTS CORPORATION IS NOT RESPONSIBLE FOR ANY UNAUTHORIZED REPAIRS, OR ANY REPAIRS MADE BY UNAUTHORIZED PROCEDURES.**

Use of the incorrect part or the failure to exercise due care in the installation, removal, servicing, checkout or calibration of parts and equipment may result in damage or possible malfunction of the equipment. This may also result in damage to property and injury including death. The purchaser and installer of these parts shall bear full responsibility and liability for the above.

All maintenance performed within the applicable warranty period (see warranty card) must be authorized in advance by Bird Products Corporation service representative in order to retain the warranty status of the subject unit.

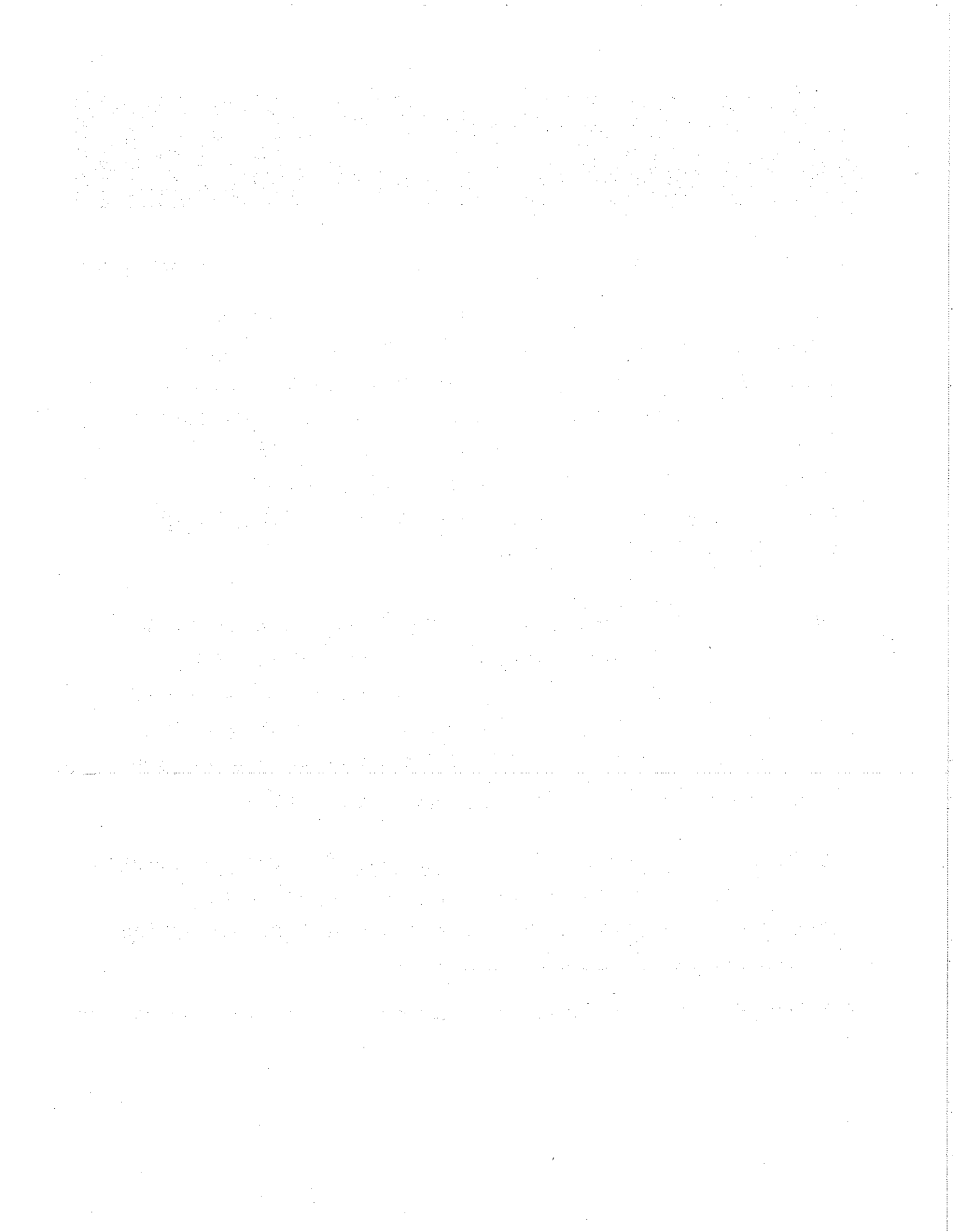

CONTENTS

	PAGE
GENERAL INFORMATION	
SECTION 1: Introduction, Definition of Repair - Maintenance - Overhaul	1-1
SECTION 2: Specifications	2-1
SECTION 3: Description of the Display, Controls and Alarm Indicator	3-1
SECTION 4: Assembly Instructions	4-1
SECTION 5: Overview of the 8400ST Volume Ventilator System Operation	5-1
■ Pneumatic	5-2
■ 8400ST Circuit Boards Theory of Operation	5-9
SECTION 6: Warnings, Cautions and Notes	6-1
SECTION 7: Cleaning and Sterilization	7-1
MAINTENANCE OVERHAUL	
SECTION 8: Maintenance Service Policy	8-1
SECTION 9: 8400ST Tools & Equipment List	9-1
SECTION 10: Maintenance Kits	10-1
SECTION 11: Disassembly	11-1
SECTION 12: Assembly	12-1
SECTION 13: Critical Component Removal/Replacement Procedures	13-1
SECTION 14: Operational Verification Procedures & Performance Test	14-1
■ Pre-Calibration	14-2
■ Calibration	14-10
■ Post Calibration/Final Assembly	14-17
■ Performance Test	14-18

INDEX

	PAGE
SECTION 15: Troubleshooting	15-1
■ Clinical	
■ Electronic	
SECTION 16: Schematics - Drawings	16-1
SECTION 17: Parts List	17-1
SECTION 18: Appendix	18-1
■ Explanation of Abbreviations	
SECTION 19: Service Bulletins	19-1
SECTION 20: Non-Recoverable "Vent Inop" Codes	20-1
SECTION 21: Warranty	21-1

ORDERING INFORMATION

Contact your Bird Products Corporation
Dealer or Bird Products Corporation
Customer Service Department directly:

1100 Bird Center Drive
Palm Springs, CA 92262
(760) 778-7200 or
(800) 328-4139
Fax: (760) 778-7274

TECHNICAL INFORMATION

Contact Bird Products Corporation
Technical Service Department directly:

1100 Bird Center Drive
Palm Springs, CA 92262
(760) 778-7200 or
BIRD HELPLINE
(800) 934-BIRD
[(800) 934-2473]

SECTION 1

Introduction

THE UNIVERSITY OF CHICAGO

PHYSICS DEPARTMENT

PHYSICS 354

PROFESSOR JOHN H. COOPER

SECTION 1

INTRODUCTION

The 8400ST Volume Ventilator Service Manual contains pneumatic and electronic theories of operation, calibration, troubleshooting, replacement, and maintenance instructions to assist a qualified service technician in the maintenance of the ventilator.

The Service Manual is specifically intended for use by an authorized service person; that is, a person that has attended a 8400ST service seminar conducted or authorized by Bird's Service Training Center. Any repairs, adjustments, or procedures that exceed the scope of this manual should be referred to the Bird Products Corporation Technical Service Center. For specific operating instructions and clinical theory of operation, refer to the 8400ST Operating Instruction Manual, P/N L1141, or Sections 2 through 7 of this manual. Service personnel should become thoroughly familiar with the Operating and Maintenance procedures before attempting service on this equipment. The WARNINGS, CAUTIONS, and NOTES should be given particular attention.

Sections 8 through 17 of this manual cover the details related to the diagnoses and replacement of defective subassemblies of the 8400ST ventilator. This manual is structured around the concept of isolating a problem to a defective **subassembly** and replacing that defective **subassembly**. The manual does not cover diagnoses and repair of, for example, component failures on the printed circuit board subassemblies; however, complete schematic information is provided to give the service technician complete technical information. Defective subassemblies can be replaced in the field by factory trained technical personnel.

Only factory trained personnel should attempt diagnosis and repair of a 8400ST ventilator. Bird's service training classes are based on fault analysis and repair at the subassembly level and also include detailed training on how to perform the 15,000 hour maintenance of the ventilator.

The maintenance schedule for a 8400ST ventilator includes preventative maintenance through the first 15,000 hours as follows:

Every 1000 hours:	examine inlet filter; replace as necessary.
Every 3000 hours:	verify transducer calibration.
Every 5000 hours:	replace bacteria filter in patient circuit.
15,000 hours:	COMPLETE OVERHAUL

The 15,000 hour overhaul may be done by any factory trained service technician. It is important, however, that the overhaul be done using only the maintenance components provided by Bird Products Corporation. In addition, no overhaul should be considered complete until an Operational Performance Verification test has been performed in accordance with Section 14 of this manual.

All repair and maintenance, including the 15,000 hour overhaul, can be done at any facility where proper service equipment is available to qualified, trained service technicians.

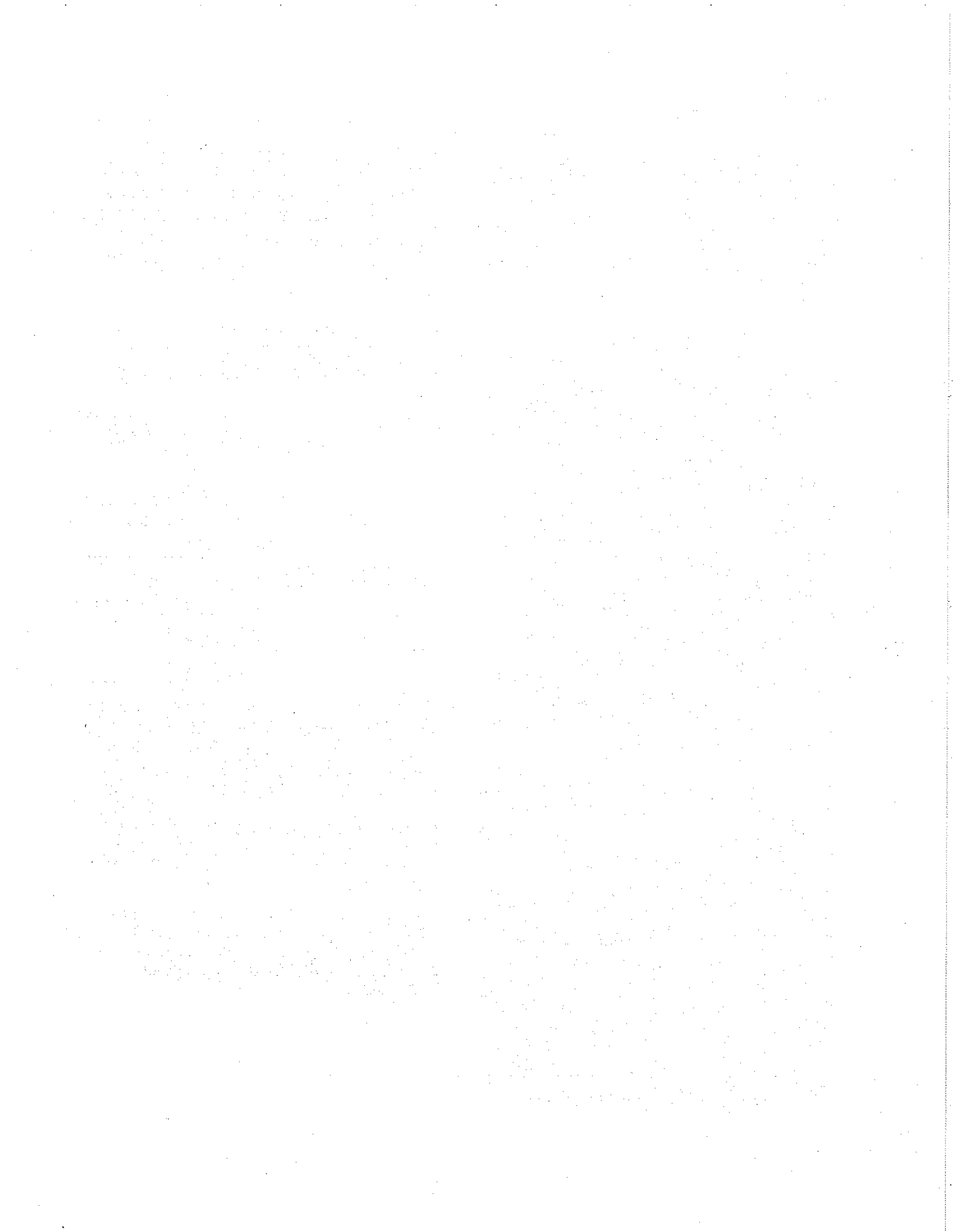

SECTION 2

Specifications

1. The first part of the document discusses the importance of maintaining accurate records of all transactions.

2. It is essential to ensure that all data is entered correctly and consistently.

SECTION 2 PRODUCT SPECIFICATIONS

CONTROLS

Power	On/Off (I/O)
Modes	Control Assist/Control, SIMV & CPAP
*Tidal Volume	50 to 2000 ml
Peak Flow	10 to 120 lpm
*Breath Rate	0 to 80 bpm
Waveforms	Square, Decelerating
Pressure Support	Off to 50 cmH ₂ O
Assist Sensitivity	-1 to -20 cmH ₂ O, OFF
PEEP/CPAP	0 to 30 cmH ₂ O
Manual Breath	Touch Button Activated
Inspiratory Hold	6 seconds (maximum)
Sigh	On/Off - 1 Sigh/100 breaths
Sigh Volume.....	1.5 x Tidal Volume (up to 3000 ml)
Sigh High Pressure Limit.....	1.5 x set (up to 140 cmH ₂ O)
Alarm Silence	60 seconds
Alarm Reset	Touch Button
AC Line/ALT PWR Source	Slide Switch for AC or DC Operation
Alarm Volume	74 to 84 dB
Back Up Breath Rate	0 to 80 bpm

*Maximum Minute Volume Capability - 56 L @ 50 PSIG inlet to blender.

MONITORS

Power "ON"	Green Indicator Lamp
Minute Volume	0 to 130.0 L
Tidal Volume	0 to 9999 ml
Breath Rate	0 to 255 bpm
I:E Ratio	1:1.0 to 99 or 1.0 to 99:1 (INVERSE)
Airway Pressure	-20 to 140 cmH ₂ O
Battery "ON"	Yellow Indicator Lamp
Patient Inspiratory Effort	Yellow Indicator Lamp
Hourmeter	0 to 99,999 hours

ALARMS

High Pressure Limit	1 to 140 cmH ₂ O
Low Peak Pressure	Off, 2 to 140 cmH ₂ O
Low Baseline Pressure	-20 to +30 cmH ₂ O
Low Minute Volume	0 to 99.9 L
High Breath Rate	3 to 150 bpm
Low Inlet Gas	17 PSIG Internal (1.19 kg/cm ²)
Apnea Interval	10 to 60 seconds
Ventilator Inoperative	Red Indicator Lamp
CIRC	Flashing Display
<input type="checkbox"/> Mode Switch Position	Rotating Display

INPUTS

Electrical	Fuse Rating
100 VAC + 10% - 15%, 50/60 Hz, 0.75 amps -	1.25SB
120 VAC + 10% - 15%, 50/60 Hz, 0.58 amps -	1.00SB
220 VAC + 10% - 15%, 50/60 Hz, 0.35 amps -	.63SB
240 VAC + 10% - 15%, 50/60 Hz, 0.32 amps -	.63SB
11.8 - 16VDC, 5 amps (maximum)	

Pneumatic30 - 70 PSIG (2.10 - 4.90 kg/cm²)

OUTPUTS

Data Link	Optical Link for 8400ST Interface Module-RS232
-----------	---

PHYSICAL WEIGHTS & DIMENSIONS

Dimensions

Ventilator only	H - 9" (22.9cm) W - 16" (40.6cm) D - 13 1/2" (34.3cm)
Ventilator & Stand	H - 51 1/2" (130.8cm) W - 21" (53.3cm) D - 24" (60.9cm)
Ventilator & Compressor	H - 55" (138.7cm) W - 16" (40.6cm) D - 25 1/2" (64.8)

Weight

Ventilator only	32 lbs (14.5kg)
Ventilator & Stand	80 lbs (36.4kg)
Ventilator & Compressor	185 lbs. (84.1kg)

SHIPPING INFORMATION

Dimensions

Ventilator only	H - 15" (38.1cm) W - 19" (48.3cm) D - 18" (45.7cm)
Ventilator & Stand	H - 40 1/8" (102cm) W - 30 1/8" (76.5cm) D - 22 7/8" (58cm)
Ventilator w/Accessories &	H - 31" (78.7cm) W - 24" (60.9cm) D - 19" (48.3cm)
Compressor	H - 38 1/2" (97.4cm) W - 22" (55.9cm) D - 35 1/2" (90.2cm)

Weight

Ventilator only	38 lbs (17.3kg)
Ventilator & Stand	95 lbs (43.2kg)
Ventilator w/Accessories & Compressor	63 lbs (28.6 kg) 142 lbs (64.5kg)

NOTE: Product specifications are subject to change without notice.

SECTION 3

**Description of the Display, Controls
and Alarm Indicator**

SECTION 3 DESCRIPTION OF THE DISPLAY, CONTROLS AND ALARM INDICATORS

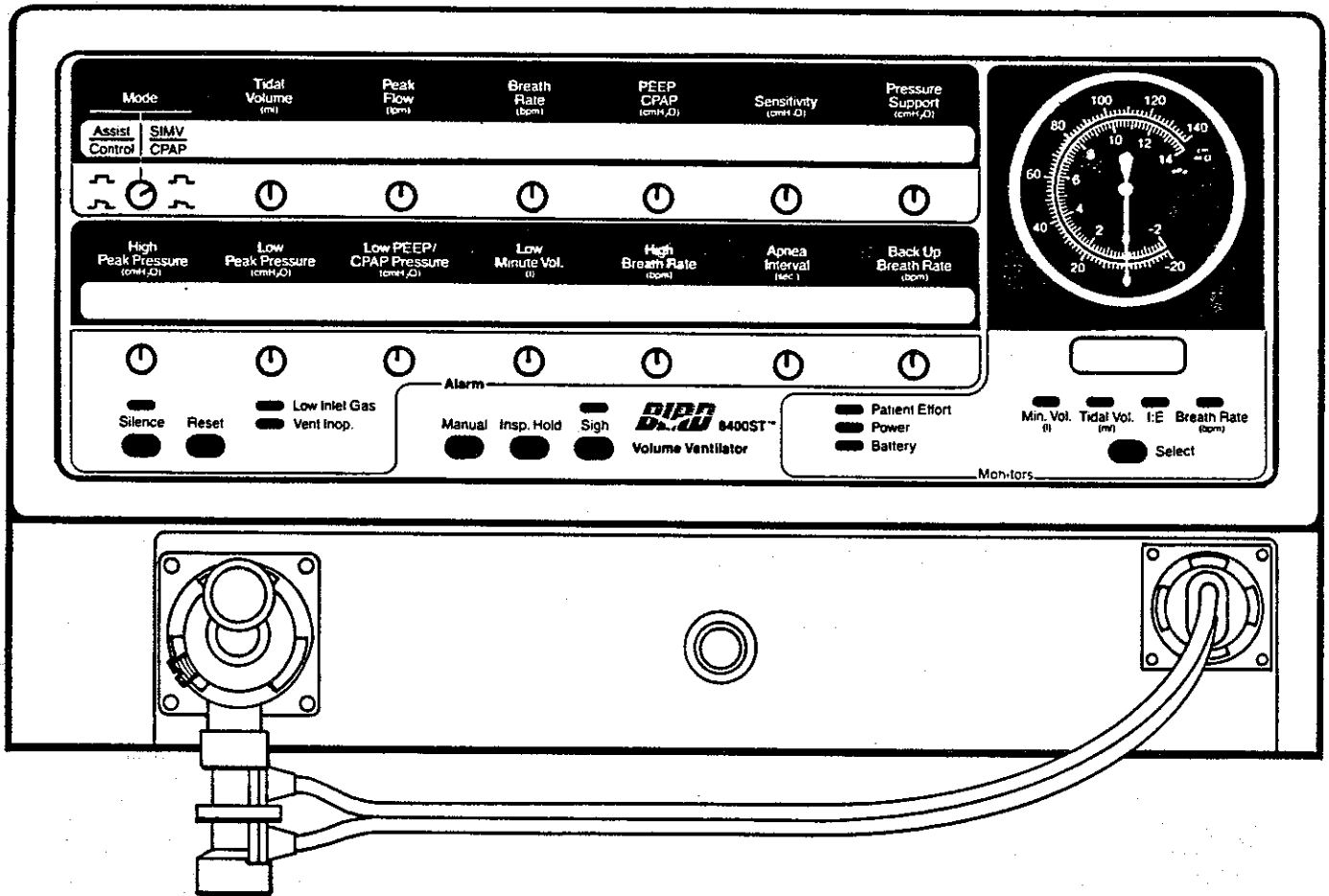

FRONT PANEL 8400ST

DESCRIPTION OF THE DISPLAY, CONTROLS AND ALARM INDICATORS

■ CONTROLS

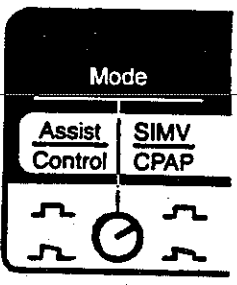
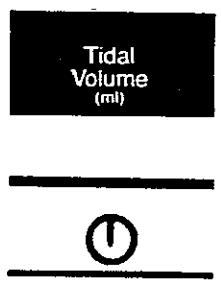
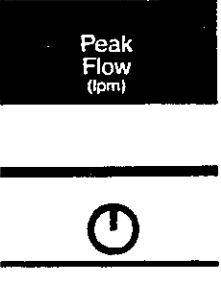
	<p>MODE CONTROL</p> <p>Dual function control for selecting flow delivery waveform and basic operating mode.</p> <p>Two basic operating selections $\left(\frac{\text{ASSIST}}{\text{CONTROL}} \text{ and } \frac{\text{SIMV}}{\text{CPAP}} \right)$</p> <p>are used in conjunction with breath rate and sensitivity controls to set up any one of four ventilation modes: Control, Assist/Control, SIMV and CPAP.</p> <p>Two waveform options are available for each of the two basic operating selections. When a square waveform flow delivery is selected, inspiratory flow is delivered at a constant rate equal to the peak flow setting. When decelerating waveform flow delivery is selected, flow is initially delivered at the peak flow setting, then decelerates to 50% of the peak flow setting at the conclusion of the mechanical delivered breath.</p>
	<p>TIDAL VOLUME CONTROL</p> <p>Sets the volume of gas delivered to the patient for controlled, assisted and Apnea Back Up Ventilation breaths.</p> <p>Range: 50 to 2000 ml</p>
	<p>PEAK FLOW CONTROL</p> <p>Sets the maximum flow delivered to the patient during controlled, assisted and Apnea Back Up Ventilation breaths. For square waveform, this is the flow rate delivered for the entire inspiratory phase. For decelerating waveform, this is the peak flow delivered before deceleration.</p> <p>Range: 10 to 120 lpm</p>

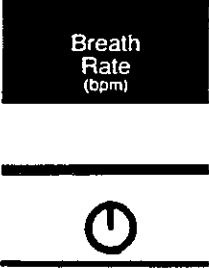
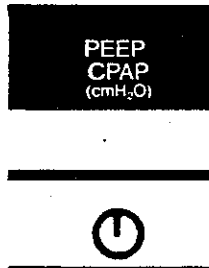
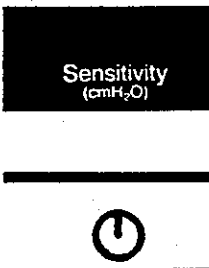
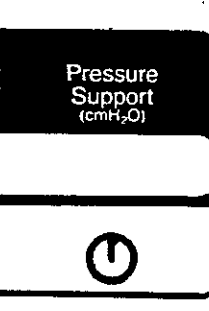
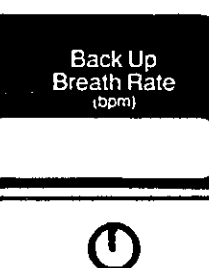
	<p>BREATH RATE CONTROL</p> <p>Sets the number of ventilator initiated breaths to be delivered to the patient per minute in the Control, Assist/Control and SIMV modes of ventilation.</p> <p>Range: 0 to 80 bpm</p>
	<p>PEEP/CPAP CONTROL</p> <p>Establishes the pressure in the patient circuit between the end of exhalation and the start of the next inspiration. Also known as baseline pressure.</p> <p>Range: 0 to 30 cmH₂O</p>
	<p>SENSITIVITY CONTROL</p> <p>Sets the trigger level below baseline pressure for the initiation of spontaneous (CPAP), pressure supported, and assisted breaths.</p> <p>Range: -1 to -20 cmH₂O, OFF</p>
	<p>PRESSURE SUPPORT CONTROL</p> <p>Sets the inspiratory patient circuit pressure during a spontaneous breath. This control is functional in SIMV/CPAP mode only.</p> <p>Range: OFF, 0 to 50 cmH₂O</p>
	<p>NOTE: This control sets the pressure level above PEEP. The total patient pressure equals PEEP + Pressure Support.</p>
	<p>NOTE: Pressure Support in the 8400ST has a preset 3 second inspiratory time limit. (See Description of Indicators in this section.)</p>
	<p>BACK UP BREATH RATE</p> <p>Sets the breath rate to be used during Apnea Back Up Ventilation. Back Up Breath Rate cannot be set to any value (other than zero) lower than the control Breath Rate setting.</p>

DESCRIPTION OF THE DISPLAY, CONTROLS AND ALARM INDICATORS

■ ALARMS

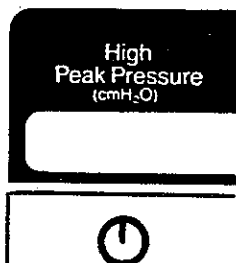

HIGH PRESSURE LIMIT ALARM

This alarm establishes the maximum allowable pressure in the patient system. Once violated, the following events will occur immediately:

1. Both audible and visual indicators will be activated.
2. The ventilator will be forced into an exhalation state, i.e., inspiratory flow is stopped and the exhalation valve opens. If the ventilator is operating correctly and there are no patient circuit kinks or occlusions, patient pressure will be reset to baseline and the audible portion of the alarm will cease.
3. If the patient pressure resets to baseline within 3 seconds, normal ventilation will resume. If the ventilator pressure remains above the High Pressure Alarm Limit for more than 0.3 seconds and/or is above baseline pressure plus 3 cmH₂O for longer than 3 seconds, the following will occur:
 - The safety system solenoid will open and pressure will begin to decrease, via a bleed orifice in the mainflow outlet check valve, back to baseline pressure.
 - At baseline pressure + 3 cmH₂O, the ventilator will reset and attempt to give another breath. If the problem is not resolved, the sequence will repeat as explained above.
 - Once corrected, the ventilator will resume normal operation.
 - The High Pressure Limit indicator will remain flashing until the reset button is activated.

The value of the alarm setting is automatically increased to 1½ times the set High Pressure Limit upon the delivery of a Sigh breath. The value cannot exceed the 140 cmH₂O maximum.

Range: 1 to 140 cmH₂O

Silence: Yes

Audible: Intermittent "Beep"





Visual: Flashing Digital Display

NOTE: This alarm cannot be set below PEEP +1 cmH₂O.

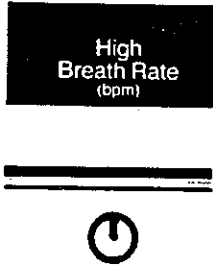
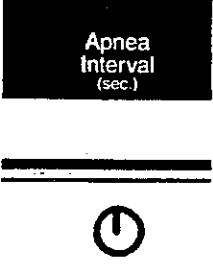
<div data-bbox="224 294 430 399" style="background-color: black; color: white; padding: 5px; text-align: center;"> Low Peak Pressure <small>(cmH₂O)</small> </div> <hr style="border: 1px solid black; margin: 10px 0;"/> <div data-bbox="300 504 349 556" style="text-align: center;"> </div>	<p>LOW PEAK PRESSURE ALARM</p> <p>The Low Peak Pressure alarm is activated if the airway pressure fails to exceed the alarm setting during the inspiratory phase of a breath. This alarm is active for all breath types.</p> <p style="margin-left: 40px;">Range: Off, 2 to 140 cmH₂O</p> <p style="margin-left: 40px;">Silence: Yes</p> <p style="margin-left: 40px;">Audible: Intermittent "Beep"</p> <p style="margin-left: 40px;">Visual: Flashing Digital Display</p>
<div data-bbox="215 808 435 913" style="background-color: black; color: white; padding: 5px; text-align: center;"> Low PEEP/ CPAP Pressure <small>(cmH₂O)</small> </div> <hr style="border: 1px solid black; margin: 10px 0;"/> <div data-bbox="300 1018 349 1071" style="text-align: center;"> </div>	<p>LOW PEEP/CPAP PRESSURE ALARM</p> <p>The Low PEEP/CPAP Pressure Alarm is activated if the airway pressure drops below the alarm setting at any time during the ventilation cycle for longer than 0.5 seconds.</p> <p style="margin-left: 40px;">Range: -20 to +30 cmH₂O</p> <p style="margin-left: 40px;">Silence: Yes</p> <p style="margin-left: 40px;">Audible: Intermittent "Beep"</p> <p style="margin-left: 40px;">Visual: Flashing Digital Display</p> <p>NOTE: Low PEEP/CPAP alarm can be set below zero baseline to detect return of ventilatory drive of a patient previously being controlled.</p>
<div data-bbox="215 1501 427 1606" style="background-color: black; color: white; padding: 5px; text-align: center;"> Low Minute Vol. <small>(l)</small> </div> <hr style="border: 1px solid black; margin: 10px 0;"/> <div data-bbox="300 1711 349 1764" style="text-align: center;"> </div>	<p>LOW MINUTE VOLUME ALARM</p> <p>This alarm is activated whenever the minute ventilation, as measured by the volume monitoring system at the exhalation valve, does not exceed the alarm setting. The Low Minute Volume Alarm applies to all breath types.</p> <p style="margin-left: 40px;">Range: 0 to 99.9 L</p> <p style="margin-left: 40px;">Silence: Yes</p> <p style="margin-left: 40px;">Audible: Intermittent "Beep"</p> <p style="margin-left: 40px;">Visual: Flashing Digital Display</p>

DESCRIPTION OF THE DISPLAY, CONTROLS AND ALARM INDICATORS

	<p>HIGH BREATH RATE ALARM</p> <p>The High Breath Rate alarm is activated if the total breath rate (spontaneous plus machine) exceeds the alarm setting.</p> <p>Range: 3 to 150 bpm Silence: Yes Audible: Intermittent "Beep" Visual: Flashing Digital Display</p>
	<p>APNEA INTERVAL</p> <p>This alarm sets the apnea time interval. If no breaths (either machine or spontaneous) are sensed within the selected time interval, an audible and visual alarm is activated and Apnea Back Up Ventilation is initiated. Apnea Interval alarm is active in all modes.</p> <p>Range: 10 to 60 seconds Silence: Yes Audible: Intermittent "Beep" Visual: Flashing Digital Display; "AP" alternates with Apnea Interval setting</p>
	<p>FLOW TRANSDUCER DISCONNECT ALARM</p> <p>The 8400ST is designed to operate with or without the flow transducer. If the flow transducer assembly is disconnected during operation of the ventilator, the following will occur:</p> <ul style="list-style-type: none"> ■ An audible alarm sounds ■ "---" appears in the Low Minute Volume alarm setting display window. ■ The Monitor section will sequentially display only I:E Ratio and Breath Rate. <p>Depression of the Alarm Silence button will silence the audible alarm for 60 seconds.</p> <p>Depression of the Alarm Reset button will defeat the audible alarm until a flow transducer assembly is again connected to the ventilator.</p>

	<p>ALARM SILENCE</p> <p>Allows the operator to temporarily disable the audible alarm signal. Activating this control again, within the 60 second silence period will restore the audible alarm.</p> <p style="text-align: center;">Duration: 60 seconds</p> <p>NOTE: During an alarm condition resulting from loss of electrical power to the ventilator, continuous depression of the alarm silence button for 3-5 seconds will silence the alarm until power is resumed.</p>
	<p>ALARM RESET</p> <p>Resets the visual alarm indication of any alarm condition which no longer exists. Resets Apnea Back Up ventilation to normal ventilator operation. Defeats flow transducer disconnect alarm. Will not reset a Ventilator Inoperative condition.</p>
	<p>ALARM LOUDNESS</p> <p>Located on the rear panel, the alarm loudness knob varies the audible alarm level.</p> <p style="text-align: center;">Range: 74dB to 84dB @ 1 meter</p>
	<p>LOW INLET GAS ALARM</p> <p>Alarm is activated whenever ventilator internal system gas pressure drops below 17 PSIG (1.19 kg/cm²). If this pressure drops below 16 PSIG (1.12 kg/cm²) for 1 second, an audible and visual Ventilator Inoperative state will be signaled. The alarm can be caused by any of the following conditions:</p> <ul style="list-style-type: none"> a) Low inlet gas pressure b) Clogged inlet filter c) Regulator malfunction d) System pressure transducer malfunction <p style="margin-left: 40px;">Silence: No Audible: Continuous Tone Visual: Flashing LED</p>

DESCRIPTION OF THE DISPLAY, CONTROLS AND ALARM INDICATORS

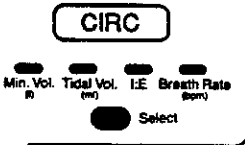
 <p> <input type="checkbox"/> Low Inlet Gas <input type="checkbox"/> Vent Inop. </p>	<h3>VENTILATOR INOPERATIVE ALARM</h3> <p>This alarm condition causes the ventilator to cease normal gas delivery and activate a safety system, allowing the non-apneic patient to breathe spontaneously from "room" air.</p> <p>The Ventilator Inoperative state will be activated if any of the following conditions occur:</p> <ul style="list-style-type: none"> *a) Loss of electrical power *b) Extended low ventilator inlet gas pressure, less than 16 PSIG (1.12 kg/cm²) or greater than 24 PSIG (1.68 kg/cm²) for 1 sec. c) A system failure is detected by the ventilator control system, either electrical or mechanical. <p>* These are recoverable Ventilator Inoperative conditions. The ventilator will resume normal operation once the conditions have been corrected.</p> <p>Silence: a) Loss of Electrical Power: yes b) Loss of Inlet Gas Pressure: no c) System failure: no</p> <p>Audible: Continuous Alarm Visual: Flashing LED</p>
 <p> <input type="button" value="CIRC"/> <input type="checkbox"/> Min. Vol. <input type="checkbox"/> Tidal Vol. <input type="checkbox"/> I:E <input type="checkbox"/> Breath Rate <input type="checkbox"/> Select </p>	<h3>"CIRC" DISPLAY</h3> <p>This alarm detects possible patient circuit or pressure transducer faults by comparing pressure measurements from the airway pressure transducer and the machine pressure transducer. If a pressure mismatch occurs, a "CIRC" message will be visually displayed in the "Monitors" display window along with an audible alarm. The following differences between the airway pressure transducer and the machine pressure transducer will activate the alarm:</p> <ul style="list-style-type: none"> ■ Inspiration: <p>While in the inspiratory phase, if the machine pressure is more than 29 cmH₂O above or 9 cmH₂O below airway pressure for longer than 100 msec, the alarm will activate.</p>

"CIRC" DISPLAY (Con't)

■ Exhalation:

While in the exhalation phase, if the machine pressure is more than 29 cmH₂O above or 9 cmH₂O below airway pressure for longer than 1 second, the alarm will activate.

Once activated, the ventilator is immediately forced to the exhalation phase with the higher of the two pressures (either airway or machine pressure) fed to the exhalation servo for purposes of PEEP control. If the mismatch condition continues for greater than 10 - 12 seconds, the safety and exhalation valves will be opened in an attempt to allow the patient to breathe spontaneously. When the mismatch condition no longer exists and the higher of the two pressures drops below PEEP + 3 cmH₂O the unit will resume normal ventilation.

The following conditions can cause this alarm to be activated:

- a) Blocked airway pressure sensing port
- b) Occluded or kinked inspiratory or expiratory limb of breathing circuit
- c) Transducer failure (either airway pressure or machine pressure transducer)

Silence: No

Audible: Intermittent "BEEP"

Visual: Flashing Digital Display

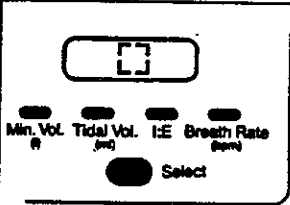

NOTE: When the airway pressure sensing port becomes blocked, the 0.05 to 0.1 lpm Purge Flow causes the manometer pressure to rise to 100 cmH₂O. The pressure seen on the manometer is not patient airway pressure. Approximately 10 seconds from the "CIRC" alarm notification, a solenoid opens and pressure is relieved. Once the pressure is relieved back to baseline +3 cmH₂O, the ventilator resets and attempts to cycle again. If the blockage is not resolved, the process will repeat until corrective action has been implemented.

DESCRIPTION OF THE DISPLAY, CONTROLS AND ALARM INDICATORS



	<p>MODE/WAVEFORM DISCREPANCY DISPLAY</p> <p>Rotating illumination of one corner of a four corner square, gives visual indication that the mode selection switch is not properly located in one of the available positions for mode and waveform selection. Accompanying the visual display is an audible alarm that will only reset when correct switch positioning is attained.</p> <p>Should the mode switch not be properly positioned while ventilator is in operation, the 8400ST will stay in the previous settings for mode and waveform. Concurrently, the visual and audible alerts will be activated.</p> <p>Should the mode switch not be properly positioned during initial ventilator power-up, a default position of SIMV and decelerating waveform will be selected. Concurrently, the visual and audible alerts will be activated.</p> <p>Silence: Yes</p> <p>Audible: Intermittent "BEEP"</p> <p>Visual: Rotating illumination of one corner of a four corner square in "Monitors" display window.</p>
---	--

■ INDICATORS



	<p>PRESSURE SUPPORT INSPIRATORY TIME LIMIT</p> <p>Pressure Support on the 8400ST incorporates a preset 3 second inspiratory time limit. Should inspiratory flow fail to reach 25% of the peak value during that breath (as might occur with a substantial air leak in the system), the Pressure Support breath will be terminated and the Pressure Support control digital display will flash.</p>
<p> Patient Effort</p>	<p>PATIENT EFFORT INDICATOR</p> <p>Indicates when an inspiratory effort meets or exceeds the sensitivity setting. This indicator will flash at the initiation of the following breath types: Assisted, Pressure Supported and Spontaneous.</p>

 I:E	<p>I:E RATIO LED FLASHING</p> <p>Indicates an inverse I:E ratio has been set. This indicator will flash as long as the combination of set breath rate, tidal volume and flow create an inverse I:E ratio. The flashing will stop when the set parameters no longer create an inverse I:E ratio.</p>
 Power	<p>POWER "ON" INDICATOR</p> <p>Green Indicator lamp, illuminates when the main power switch is "ON" and AC power is connected and the AC Line/ALT Power switch is in AC Line position.</p>
 Battery	<p>BATTERY INDICATOR</p> <p>Yellow Indicator lamp, illuminates when unit is operating from external 12 VDC power source. Input power must be 11.8 - 16 VDC.</p> <p>NOTE: Back panel switch must be in the DC (ALT PWR Source) position.</p>

■ MONITORS



 Select	<p>MONITOR SELECT BUTTON</p> <p>Depression of this button allows for visual display of monitored parameters.</p> <p>1) Minute Volume; 2) Tidal Volume; 3) I:E Ratio; 4) Breath Rate. When pressed repeatedly, sequentially displays 1 through 4, then jumps from 4 to 1.</p>
 Min. Vol. (0)	<p>MINUTE VOLUME DISPLAY</p> <p>Displays minute volume of all breath types as measured by the flow transducer. Minute volume is calculated on an eight breath average as follows:</p> <p>Total Breath Rate X Sum Of Last 8 Tidal Volumes (ml)/ 8 X (1L / 1000 ml)</p> <p>Updated on a breath by breath basis.</p>

DESCRIPTION OF THE DISPLAY, CONTROLS AND ALARM INDICATORS



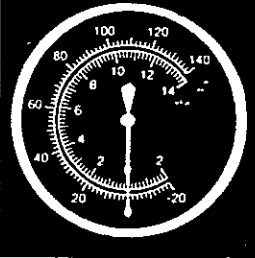

 Tidal Vol. (ml)	<p>TIDAL VOLUME DISPLAY</p> <p>Displays tidal volume for all breath types as measured by the volume monitoring system. The tidal volume display is updated on a breath by breath basis.</p> <p style="text-align: center;">Range: 0 to 9999 ml</p>
 I:E	<p>I:E RATIO DISPLAY</p> <p>Displays the value calculated as the ratio between inspiratory time and expiratory time for machine breaths only. Updated on a breath by breath basis. If breath rate is set to "0", then I:E ratio window will display - - - -.</p> <p style="text-align: center;">Range: 1:1.0 to 99, or 1:0 to 99:1</p>
 Breath Rate (bpm)	<p>BREATH RATE DISPLAY</p> <p>Displays the average breath rate per minute (calculated on an eight breath average) for all breath types according to the following formula:</p> <p style="text-align: center;">8 Breaths/Sum Of The Last 8 Breath Periods (min)</p> <p style="text-align: center;">Updated on a breath by breath basis.</p> <p>NOTE: If an inspiration (mechanical or spontaneous) is not detected within the Apnea Interval setting the breath rate will display zero, the apnea alarm will be initiated and Apnea Back Up ventilation will begin.</p>

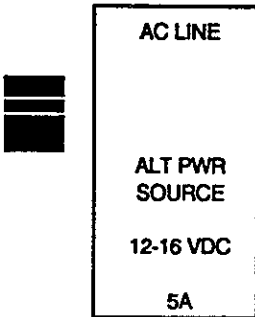
■ MISCELLANEOUS

	<p>AIRWAY PRESSURE DISPLAY</p> <p>Displays airway pressure.</p> <p style="text-align: center;">Range: - 20 to 140 cmH₂O</p>
---	---

<p>Manual</p> 	<p>MANUAL BREATH BUTTON</p> <p>Used to deliver a single, operator initiated controlled breath. Tidal Volume, Waveform and Peak Flow are per control panel settings. Manual Breath requests which occur during the inspiratory or minimum exhalation phases of all breath types are ignored. Manual Breath available in all modes of ventilation. Manual Breath is non-functional during Ventilator Inoperative state.</p>
<p>Insp. Hold</p> 	<p>INSPIRATORY HOLD BUTTON</p> <p>When this button is depressed and held, an inspiratory hold will occur after the end of the next volume mandated breath until either the button is released or 6 seconds has elapsed, whichever occurs first. During the inspiratory hold, both the flow valve and the exhalation valve will remain closed to allow reading of static inspiratory pressure from the airway pressure manometer.</p> <p>During the inspiratory hold, both the breath rate timer and apnea interval timer will also be on hold to prevent breath stacking and inadvertent apnea alarms.</p>
<p>Sigh</p> 	<p>SIGH "ON/OFF" BUTTON</p> <p>Activates the automatic Sigh function allowing a Sigh breath once every 100 breaths. The Sigh breath is a controlled breath equal to 1½ x the Tidal Volume setting, delivered at a flow rate equal to the Peak Flow setting. The high pressure limit is automatically increased to 1½ x set value (up to a maximum of 140 cmH₂O) during a Sigh breath. Sigh function available in all modes of ventilation.</p> <p>Range: 75 to 3000 ml</p>
 <p>AC LINE</p> <p>ALT PWR SOURCE</p> <p>12-16 VDC</p> <p>5A</p>	<p>AC/DC SWITCH</p> <p>Switches power source from AC LINE to 12 VDC alternate external power supply.</p>

DESCRIPTION OF THE DISPLAY, CONTROLS AND ALARM INDICATORS

 <p>DATA LINK</p>	<p>DATA LINK</p> <p>Provides optical connection of the 8400ST to other devices.</p>
	<p>HOURMETER</p> <p>The hourmeter records the total hours of ventilator operation. It is activated whenever the ventilator is AC line or 12VDC battery operated. The meter is non-resettable and records to the whole hour. The hourmeter allows the clinician to determine the actual usage hours as well as for establishing routine maintenance schedules.</p>
	<p>POWER MODULE</p> <p>Power module turns AC power On(I) and Off(O), accepts power cord and encloses fuse package for over current protection.</p>
	<p>DC INPUT RECEPTACLE</p> <p>Allows for attachment of an external 12 VDC power supply for emergency or transport application.</p>

SECTION 4

Assembly Instructions

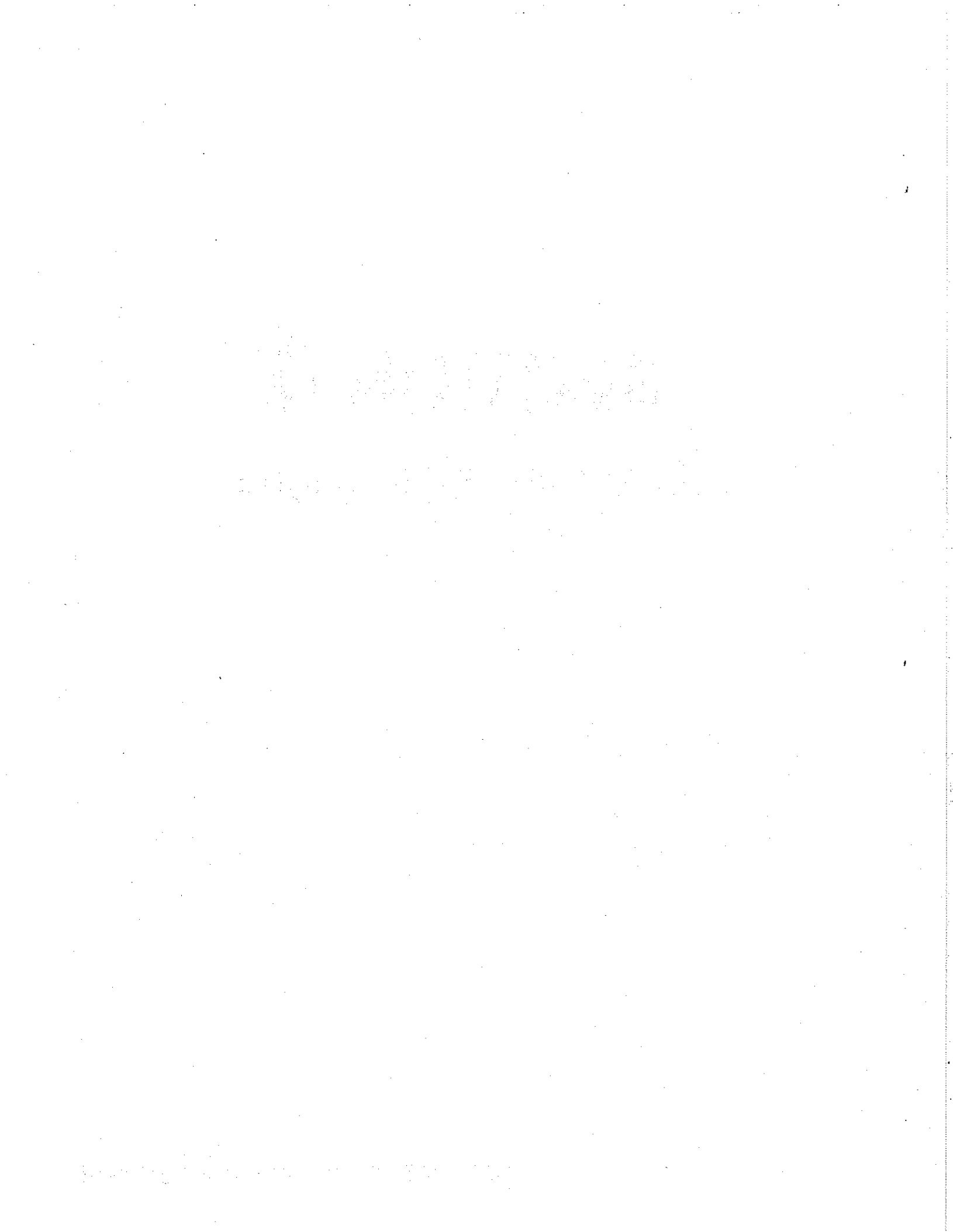

SECTION 4 ASSEMBLY INSTRUCTIONS

Prior to setting up the 8400ST Volume Ventilator, the operator must first read and understand Section 6 - "Warnings, Cautions and Notes."

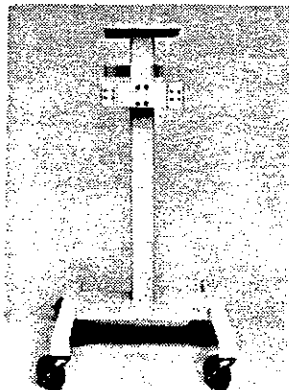

1. Assemble stand as directed on page A-1 in the Addenda Section. Then go to step 2 on this page.

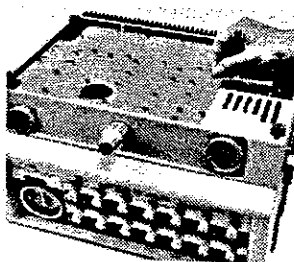

2. Place ventilator on its top, then install two (2) each alignment pins (P/N 04825) in diagonal corners as shown. Finger tighten to secure.

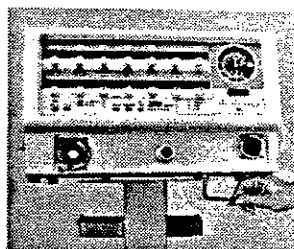

3. Install ventilator onto stand (P/N 04820) and secure in place with two (2) screws (P/N 03275) with $\frac{3}{16}$ " Allen wrench.

NOTE: Alignment pins (P/N 04875) position ventilator in place for attachment to stand.

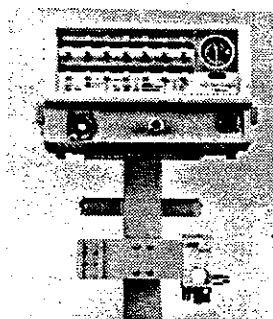

4. Install the 3800 MicroBlender into female dovetail bracket provided on ventilator stand (P/N 04820).

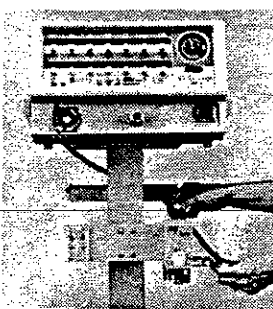

5. Attach one end of supply hose (P/N 09520) to 90° elbow adapter (P/N 00066), then connect elbow adaptor to auxiliary outlet of 3800 MicroBlender and the other end of supply hose to DISS Male fitting at back of ventilator. Next, connect air hose (P/N 02899) and oxygen hose assembly (P/N 00060) to blender inlets. (Not shown.)

WARNING:

WHEN USING THE 3800 MICROBLENDER IN CONJUNCTION WITH THE 8400ST VOLUME VENTILATOR, ALWAYS CONNECT P/N 09520, THE VENTILATOR/BLENDER HOSE ASSEMBLY, TO THE AUXILIARY OUTLET OF THE BLENDER. BLENDER AUXILIARY OUTLET CONNECTION WILL ENSURE ACCURACY OF OXYGEN DELIVERY AT THE LOWER FLOW SETTINGS OF THE VENTILATOR.

ASSEMBLY INSTRUCTIONS

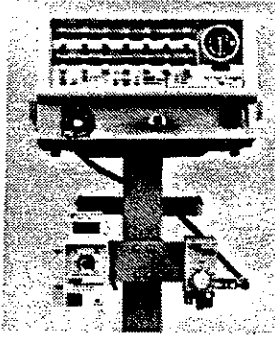

6. Install the Heated Humidifier Controller into female dovetail provided on Ventilator Stand (P/N 04820).

7. Wick Installation and Heater Module Assembly Instructions as follows:

c) Insert a new wick following the steps below. For the individually packaged, sterilized wick:

- Peel open bag.
- “Pop” wick into cylindrical shape.
- Insert wick through bottom of main body. Do not insert wick through top of main body.
- Gently push the wick in until it meets top cap. Approximately 3/8 inch of the wick will extend below the main body. Do not bend or fold exposed portion of wick by forcing it further.

d) Float pad should be free of damage. Apply even pressure to upper float assembly for insertion into lower Float Assembly.

e) Hand-tighten the Dual Float Bottom Cap Assembly on the Humidifier Heater Module.

WARNING:

ASSEMBLY OF THE HUMIDIFIER HEATER MODULE AND/OR INSERTION OF THE WICK IN A SEQUENCE OTHER THAN DESCRIBED BELOW MAY CAUSE A FAILURE OF THE WATER FEED SYSTEM AND MALFUNCTION OF THE HEATER MODULE.

a) Inspect metal water feed tube in center of top cap. If the tube is bent or tip is occluded or deformed, discard and replace with new Top Cap.

b) Twist the top cap clockwise onto the main body so that the inlet port is facing the rear of the Heater Module.

8. Attach the Heater Module to the Humidifier Controller with the inlet and outlet ports positioned as shown.

ASSEMBLY INSTRUCTIONS

9. Assemble the 8400ST Volume Ventilator breathing circuit as follows:

- a) Attach 90° elbow adapter (P/N 04709) to ventilator outlet labeled "To Humidifier", with male portion of adapter directed down.
- b) Attach one end of short circuit tubing (P/N 09532) to the 90° elbow adapter, and the other end to the mainflow bacteria filter (P/N 09534).
- c) Insert the 22mm female adapter onto outflow side of the mainflow bacteria filter, then connect 22mm male end of 90° elbow adapter (P/N 04709) into cuff (P/N 00423). Attach entire assembly to inlet of Humidifier Heater Module.
- d) Connect one end of circuit tubing (P/N 09531) to outlet of Humidifier Heater Module, and the other end to one leg of watertrap (P/N 09413).

NOTE: Bird breathing circuit water traps (P/N 09413) have been incorporated into the inspiratory and expiratory limbs of the breathing circuit to collect excess condensate from the humidifier gas.

- e) Connect second piece of patient tubing (P/N 09531) to remaining leg of watertrap, and the other end to inspiratory side of patient "Wye" (P/N 20225).

NOTE: Inspiratory side of patient "Wye" (P/N 20225) has a large port for attachment of Humidifier Temperature Probe.

- f) Connect a third piece of circuit tubing (P/N 09531) to the expira-

tory side of patient "Wye", and other end to one leg of remaining watertrap (P/N 09413).

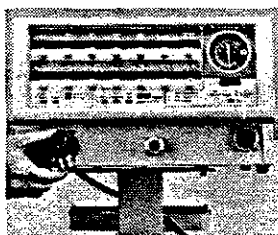
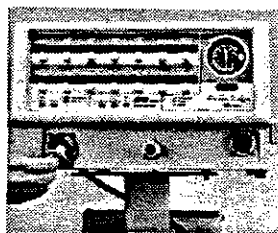

- g) Install Exhalation Valve Diaphragm (P/N 20107) onto ventilator.

- h) Install Exhalation Valve Body (P/N 20005) onto ventilator.

NOTE: Once the Exhalation Valve Body (P/N 20005) is properly installed into the Exhalation Valve Assembly, a spring loaded safety tab will engage and ensure placement.

- i) Connect the last piece of the patient circuit tubing (P/N 09531) to remaining leg of watertrap, and other end to exhalation valve body on front of ventilator.

10. Secure the remote temperature sensor into the patient "Wye" and insert the remote sensor plug into the Humidifier Controller.

11. Flow Transducer (P/N 10081R) installation:

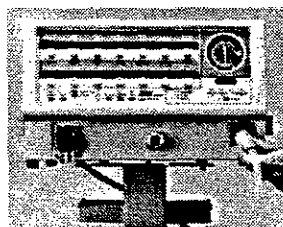

- a) Install male portion of the Flow Transducer Assembly (gray connector) into the female receptacle on front of ventilator casting and turn clockwise to lock into position.

NOTE: When properly installed, a click will be heard and the reference marks will be in alignment.

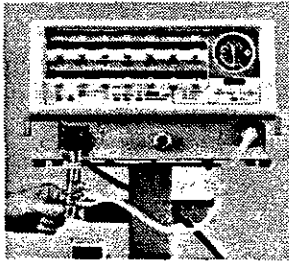

- b) Attach opposite end of Flow Transducer Assembly into the Exhalation Valve Body (P/N 20005) outlet port. Be sure that the arrow on the body of the flow transducer is pointing in the direction of gas flow.

NOTE: Position the Flow Transducer Pressure lines so that they are directed towards the right side of the ventilator as shown above

- c) Ensure all connections are secure.

WARNING:

BEFORE PATIENT APPLICATION, "PRESSURE TEST" THE PATIENT CIRCUIT INCLUDING HUMIDIFIER HEATER MODULE FOR POSSIBLE AIR LEAK DUE TO MISASSEMBLY OR DAMAGED COMPONENTS. (SEE SECTION 14 - PERFORMANCE TEST)

For additional information on the Bird Heated Humidifier and Bird 3800 MicroBlender, refer to the following instruction manuals:

- L1001 - Bird Heated Humidifier Instruction Manual
- L1008 - Bird 3800 MicroBlender Instruction Manual

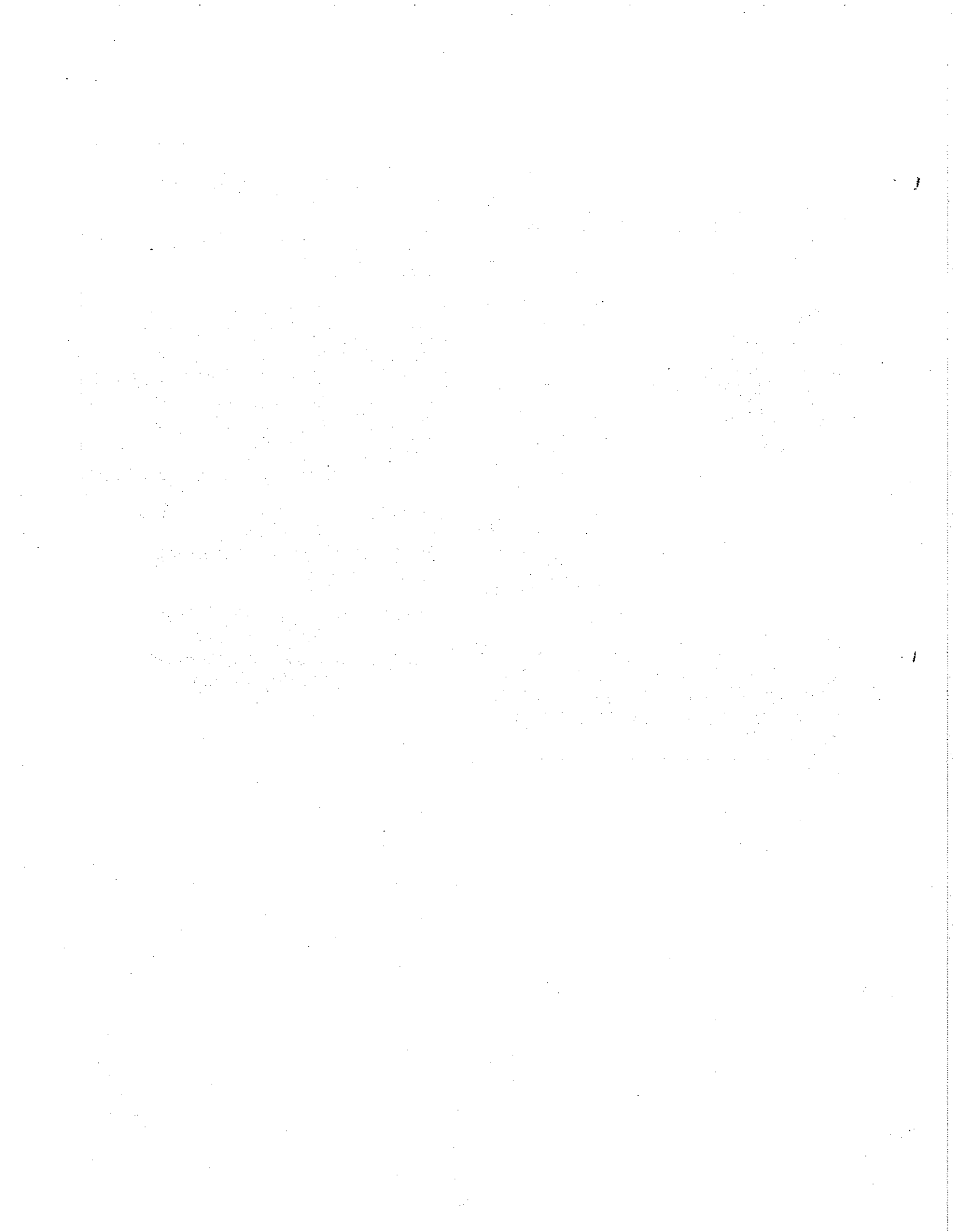

SECTION 5

Overview of the 8400ST Volume Ventilator System Operation

Handwritten text, possibly a list or notes, consisting of several lines of illegible script.

SECTION 5 OVERVIEW OF THE 8400ST VENTILATOR SYSTEM OPERATION

■ PNEUMATIC THEORY OF OPERATION

■ INTRODUCTION

The 8400ST Volume Ventilator is an electronically controlled, pneumatically activated device capable of supporting a wide range of patients. The electronic control system is based on three microprocessors: a main processor, a flow valve control processor and a display/exhalation valve control processor. The main processor controls overall ventilator functions such as breath rate timing and volume while the valve control processors control the actual motion of flow and exhalation valves.

The pneumatic system is based on two main electro-mechanical valves, the Flow Control Valve and Exhalation Valve. All gas delivery to the patient is controlled by the Flow Control Valve while all exhaled flow from the patient is controlled by the Exhalation Valve.

The main flow of gas through the 8400ST is shown in Figure 1. The Pneumatic components are described in the following pages and keyed to the numbers in Figure 1.

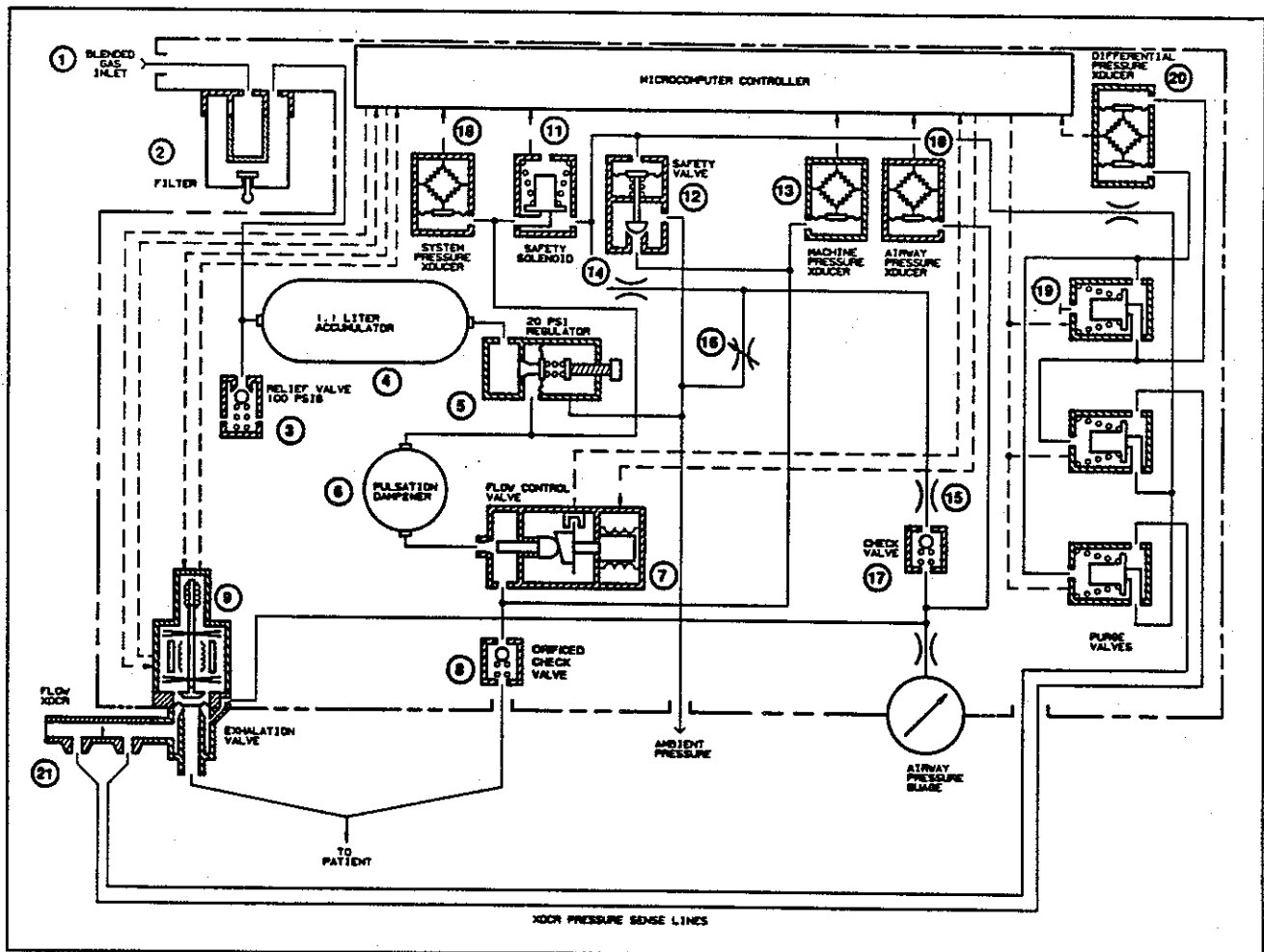
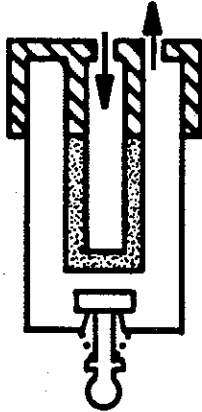

FIGURE 1. PNEUMATIC SCHEMATIC, 8400ST VOLUME VENTILATOR

OVERVIEW OF THE 8400ST VENTILATOR SYSTEM OPERATION

■ GAS INLET FILTER (2)



Blended gas from an external source is connected to the Blended Gas Inlet (1). The ventilator is designed to be used with the 3800 MicroBlender operating at 50 PSIG inlet pressure to the blender. When mixed gas from any other source is utilized, the alternate device must be capable of delivering flow in excess of 75 lpm within the range of 30-70 PSIG (2.10-4.90 kg/cm²) to the blended gas inlet to the ventilator.

The incoming blended gas passes through a Coalescing Filter (2) which reduces both liquid and solid particles from the gas stream. This contamination is collected in the filter bowl. A drain is provided for removal of accumulated liquid contaminants.

NOTES:

- Coalescing filter is 99.97% efficient in filtering aerosol particles down to .75 microns and solid particles down to .3 microns.
 - The flow of gas through the coalescing filter is from the inside out. The filter must be removed and examined internally for contamination.
-

■ RELIEF VALVE(3)

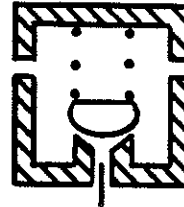

The Relief Valve (3) vents inlet gas to ambient if the inlet pressure exceeds 100 PSIG. This protects the pneumatic system in the event excessive inlet pressure is applied to the unit.

■ ACCUMULATOR(4)



Filtered gas then passes into a 1.1 liter Accumulator (4). The purpose of the Accumulator is to store pressurized gas for augmenting the blender flow during high inspiration flow demands. The 3800 MicroBlender is capable of delivering approximately 75 lpm with inlet and outlet pressures of 50 and 35 PSIG (3.50-2.45 kg/cm²) respectively, while the ventilator can deliver flow rates up to 120 lpm. This extra flow capacity is provided from gas stored in the accumulator during the exhalation phase. Since the Accumulator is a rigid vessel, charging and discharging is accompanied by large pressure variations as shown on page 5-3, Figure 2.

It should be noted that the pressure fluctuations shown in Figure 2 occur only within the accumulator and are not transmitted to the patient circuit.

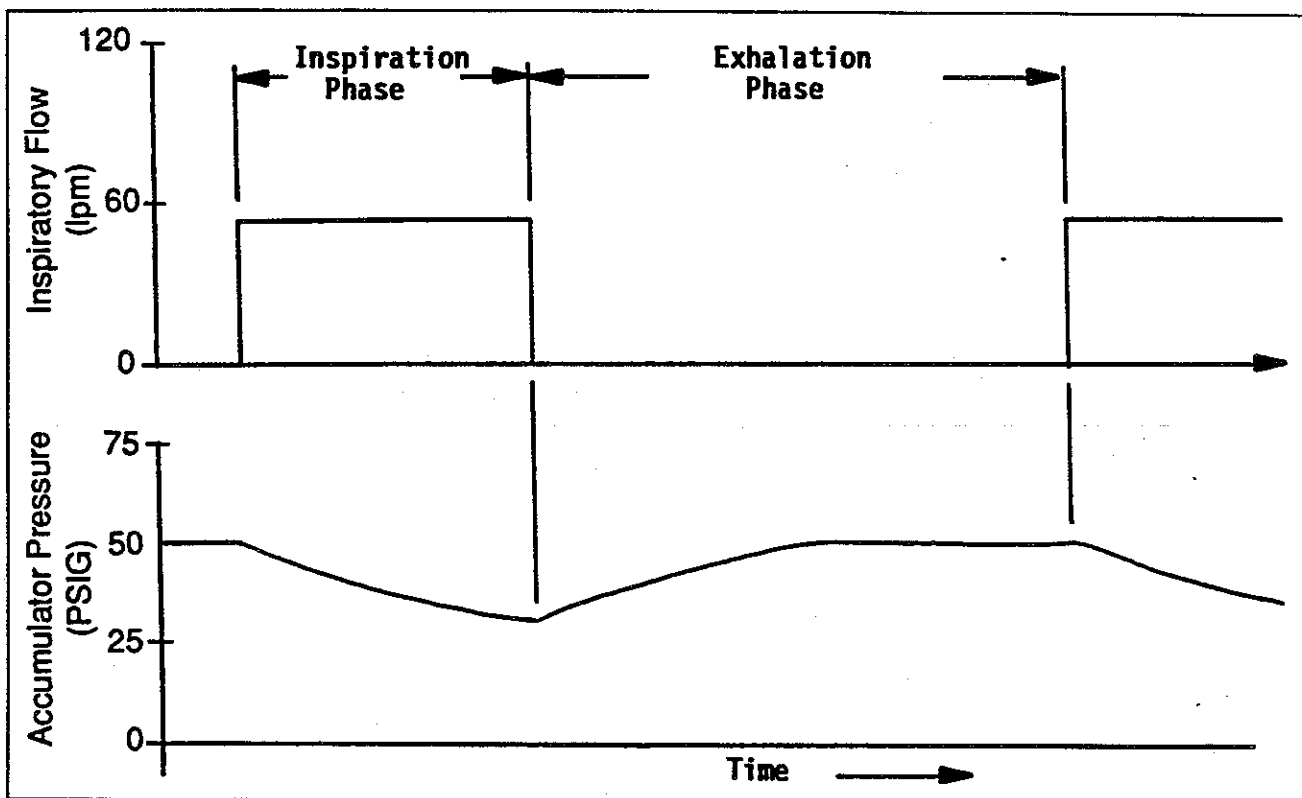
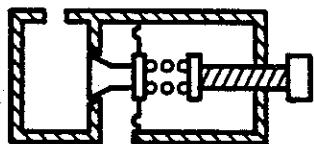

FIGURE 2. ACCUMULATOR PRESSURE WITH RESPECT TO PATIENT INSPIRATORY FLOW

■ REGULATOR(5)



A precision pneumatic Regulator (5) establishes the system pressure at 20 PSIG (1.40 kg/cm²). This pressure is used for the following functions:

1. A precise stable supply pressure to the Flow Control Valve for purposes of accurate flow control.
2. Driving pressure for the airway Pressure Line Purge function.

3. Pilot pressure for actuating the Safety Valve.
4. Driving pressure for the Flow Transducer sensing lines purge functions.

■ PULSATION DAMPENERS(6)



The Pulsation Dampener (6) is a rigid chamber with a volume of approximately 200 ml. The Flow Control Valve is capable of very fast changes in gas flow which in turn forces the regulator to respond rapidly in order to maintain a constant system pressure. During these transient flow conditions, pressure fluctuations occur due to the

OVERVIEW OF THE 8400ST VENTILATOR SYSTEM OPERATION

response time of the Regulator. The Pulsation Dampener acts as a buffer between the Flow Control Valve and Regulator by minimizing the pressure fluctuations.

■ FLOW CONTROL VALVE(7)

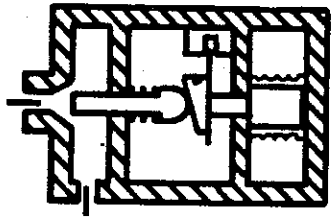

Gas flow to the patient is controlled by the Flow Control Valve (7). The valve is an electro-mechanical device. Rotary motion of the electro-mechanical driver is transformed to linear motion required for throttling flow through a variable poppet type

orifice. The valve is designed and calibrated to obtain a known relationship between position and orifice opening. With the system pressure at 20 PSIG (1.40 kg/cm²) flow through the variable orifice is sonic up to a downstream pressure of approximately 3 PSIG (210 cmH₂O). Mass flow through the valve is unaffected by downstream pressures of up to 3 PSIG (210 cmH₂O) in the patient circuit. This combination of features leads to a known relationship between the electro-mechanical driver position and flow rate which is used by the Microprocessor Controller to control flow and volume to the patient. The range of the valve is 0-120 lpm with an approximate resolution of 1 lpm/step. An optical sensor detects the 'zero' flow position.

The following table describes the method of flow delivery for various breath types:

BREATH TYPE	METHOD OF INSPIRATORY FLOW DELIVERY
Volume Controlled	Using the known relationship between valve position and flow rate, the Microprocessor Controller moves the valve in a predetermined sequence to satisfy the tidal volume, peak flow, and waveform settings.
Spontaneous	Using feedback from the airway pressure transducer, the Microprocessor Controller moves the valve to provide flow as required to maintain a stable PEEP/CPAP pressure.
Pressure Support	Identical to spontaneous breath except the flow is controlled to maintain the pressure support setting.

■ CHECK VALVE(8)

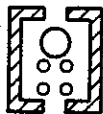

The orificed Check Valve (8) works in combination with the exhalation valve diaphragm to insure one way gas flow when the patient is breathing spontaneously. This is critical when the patient is breathing through the Safety Valve (12) with the ventilator in an inoperative condition.

■ EXHALATION VALVE(9)

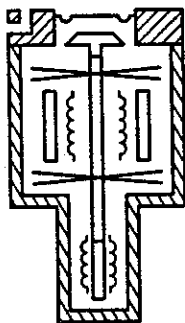

All exhaled gas from the patient is controlled by the Exhalation Valve (9). The flow of exhaled gases through a large poppet valve is controlled by a linear motion electro-mechanical actuator. The valve performs the following functions under Microprocessor Control:

1. Closes the exhalation leg of the patient circuit during all types of inspiration.
2. Opens wide at the beginning of exhalation for minimum flow resistance.

3. In conjunction with the Flow Control Valve (7), Microprocessor Controller and Airway Pressure Transducer (10), controls PEEP/CPAP to the desired level.

Additionally, the exhalation valve diaphragm acts as a check valve during spontaneous breathing to insure one way gas flow.

■ AIRWAY PRESSURE TRANSDUCER(10)

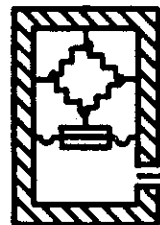

The Airway Pressure Transducer (10) converts airway pressure to an electrical analog signal. This signal is used by the Microprocessor Control system for the following functions:

- PEEP/CPAP control
- Pressure Supported Breathing
- High Pressure Limit Alarm
- Low Peak Pressure Alarm
- Low PEEP/CPAP Alarm
- Detection of Patient Initiated Breaths

OVERVIEW OF THE 8400ST VENTILATOR SYSTEM OPERATION

■ SAFETY SYSTEM(11)(12)

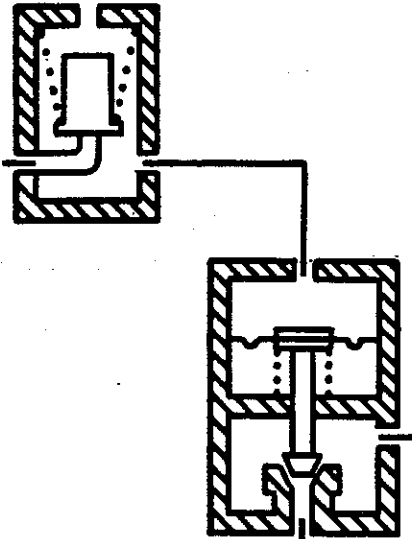

The safety system consists of a Safety Solenoid (11) that drives the Safety Valve (12). During normal operation the solenoid is open, passing 20 PSIG (1.40 kg/cm²) system pressure to the upper safety valve chamber. This closes the safety valve poppet and seals the inspiratory leg of the patient system. When electrical power is lost or the unit is in a Ventilator Inoperative state, the Solenoid closes, venting the upper chamber of the Safety Valve to ambient pressure. This opens the Safety Valve poppet allowing the patient to inspire spontaneously from 'room' air.

■ MACHINE PRESSURE TRANSDUCER(13)

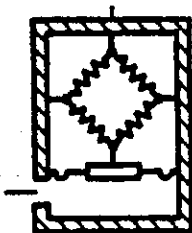

The Machine Pressure Transducer (13) monitors machine outlet pressure. This transducer is used as a safety monitor to the Airway Pressure Transducer. During certain phases of inspiration, the Microprocessor Controller compares the two pressure signals. The two signals must agree within a predetermined range of pressures (see "CIRC Display" in Section 4) which allows for transducer tolerances and pressure drops in the patient circuit during inspiration. If this test fails, the unit sounds an audible alarm and "CIRC" flashes in the monitor window.

■ AIRWAY PRESSURE SENSE LINE PURGE(14)(15)(16)(17)

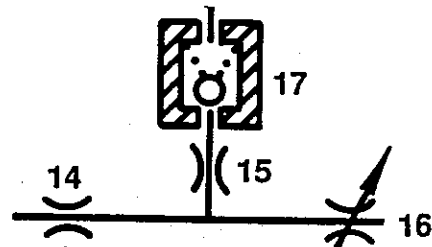

The airway pressure sense line purge provides a forward flow of blended gas through the airway pressure sense line. This prevents moisture from migrating up into the ventilator pneumatics. The two fixed orifices (14) and (15) and the variable orifice (16) are calibrated to provide a .05 - .10 lpm purge flow. In the event the line is blocked, pressure to the gauge and transducer will not exceed 100 cmH₂O. The Check Valve (17) prevents back flow into the pneumatic system in the event airway pressure exceeds purge drive pressure.

■ SYSTEM PRESSURE TRANSDUCER(18)

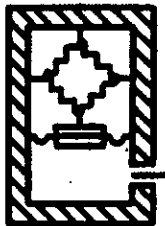

The System Pressure Transducer (18) continuously monitors the 20 PSIG (1.40 kg/cm²) system pressure and converts it to an electrical analog signal. The microprocessor compares this signal to a predetermined tolerance range. If the system pressure is out of range, the controller will activate the Low Inlet Gas Pressure Alarm or Ventilator Inoperative state depending on the severity of the out of range condition. The following conditions can cause the system pressure to be out of range:

- Insufficient gas supply
- Clogged inlet filter
- Regulator out of calibration

■ PURGE VALVES (19)

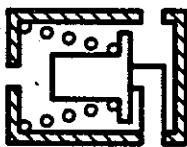

During normal operation the purge valves (19) are configured to connect the pres-

sure sense lines from the Flow Transducer to the differential pressure transducer (20) and to close off a 5.0 lpm flow source. Every 50 seconds (approx.) and during an inspiratory phase, the purge valves are designed to connect both ports of the differential pressure transducer (20) together and allow the 5.0 lpm (2.5 lpm per port) flow to purge the pressure sense lines preventing moisture from accumulating. During this purge interval a microprocessor samples the voltage from the differential pressure transducer. This voltage is then used as a zero reference point so that volume measurements can maintain their accuracy independently of temperature and component variations.

■ DIFFERENTIAL PRESSURE TRANSDUCER (20)

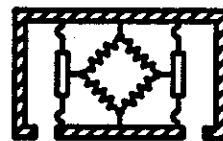

The differential Pressure Transducer (20) measures the pressure across the variable orifice of the Flow Transducer. As the flow through the transducer increases so does the differential pressure. A microprocessor then converts the differential pressure to a volumetric flow rate and then calculates both Tidal Volume and Minute Volume.

OVERVIEW OF THE 8400ST VENTILATOR SYSTEM OPERATION

■ FLOW TRANSDUCER ASSEMBLY (21)

The flow transducer assembly consists of the following components:

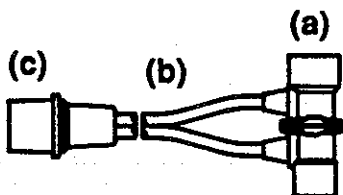

□ Variable Orifice Flow Transducer (a):

The flow transducer consists of two chambers separated by a variable orifice flow element. The flow element bends in the direction of flow and creates a small pressure difference between the two chambers. The difference in pressure is directly related to the amount of flow passing through the transducer.

When a flow transducer is properly attached to the connector port on the ventilator, the pressures in the chambers are transmitted to a differential pressure transducer (20). The differential pressure transducer measures the pressure difference between the two chambers in the transducer and then sends an analogue signal which is

digitized and "read" by the microprocessor.

Since the flow element is made from a material whose properties are known and remain constant for millions of cycles, the relationship between pressure difference and flow is known and thus can be used by the microprocessor to determine flow rate. Every four milliseconds, the microprocessor translates the measured flow to a tidal volume and minute volume. These volumes are then displayed at the beginning of the next breath cycle.

□ Pressure Sense Lines (b):

These two sense lines transmit the respective pressure of the two chambers in the flow transducer to the differential pressure transducer (20).

□ Flow Transducer Connector (c):

The flow transducer connector not only connects the flow transducer assembly to the ventilator, but also provides information required by the microprocessor to determine the proper calibration curve. Each connector incorporates an optical code which identifies the characteristic calibration curve of that transducer. This calibration is done at the factory and insures that system accuracy is maintained.

■ 8400ST CIRCUIT BOARDS THEORY OF OPERATION

The following theory of operation may be helpful to you in troubleshooting and understanding 8400ST's and their circuit boards:

MAIN BOARD 50010

Please refer to the schematic 50012 for references.

□ RESET AND CLOCK:

R64, C65, and D5 form a power on delay for the *RES* reset input, U31 pin 11. When */RST*, U19 pin 11 is a HI level, then the *RESET* pin 10 goes LO. If this pin is LO and the output from the fault monitor circuit, pin 6 is HI, the *READY* line, pin 5 goes HI and releases the clear *CLR* line at U28, pins 3, 11 and also the */RES* on the dual port ram U29 pin 27. This signal goes thru an inverter stage (R80,R81,R82,& Q2) to the microprocessor B U33 pin 9 to enable it to start running. U28 pin 12, the *RESET A* line goes LO, allowing U22 pin 9, the microprocessor to start up.

The clock signal is generated by U31, 8284-1 IC, from crystal X1. The 12 Mhz clock is output from pin 12 *OSC*, and sent to the microprocessors U22 (CPUA),U33 (CPUB) pin 19 *XTAL1* and U29 pin 20 *XTAL2*. the 2 Mhz *PCLK* from U31, pin 2 goes to the A/D converters, U16 and U20.

□ MICROPROCESSOR:

The MAIN microprocessor U22 retrieves the program instructions from EPROM U24. The EPROM is jumper selectable to be either 32K bites (27C256) or 64K (27C512) with JP2. The lower 8 bits of the address bus is multiplexed with the data bus. The lower address bus, pins 39 - 32 (*AD10 - AD17*), is routed to the left side of U23 and decoded with the *ALE1* (Address Latch Enable) line. The outputs (right side) of U23 containing only address information now, are applied to the EPROM program memory chip U24 along with the high order 8 bits of the address bus. The high 8 bits of the address bus come directly from U22 pins 21 - 28 (*A18 - A115*) without need of decoding. The program instruction is placed on the multiplexed *AD* bus when the Program Store ENable *PSEN1* signal is LO, as controlled by the microprocessor, the instruction is read into the microprocessor, U22.

OVERVIEW OF THE 8400ST VENTILATOR SYSTEM OPERATION

MAIN BOARD 50010 (Con't.)

Please refer to the schematic 50012 for references.

□ MICROPROCESSOR (Con't.):

A18, *A19*, and *A110*, *A115* are sent to U32, pins 1, 2, 3 and 6. These are decoded into Chip Enables *CSADC*, *CSMUX1*, *CSMUX2*, */CSSW1*, */CSSW2*, and */CSPAL*. These lines, and the Read and Write (*RD*, *WR*) enable the microprocessor to read data from and write data to the peripheral input output chips, (U16, U20, U15, U19, U30, U26, U27) and also the PAL U25.

The MODE switch, SW1, is read into main microprocessor port U22 pins 5-8 from pins J3 1-6.

The Front panel RESET, SIGH, SELECT, and MANUAL BREATH switches SW2 thru SW7 are latched into U27 (74HC244) from J3 pins 7-13 so that they can be read into the Main processor when requested.

The Main processor talks to the Display processor thru the Dual Port Ram U29. This is done using the data lines *A10* to *A17*, the address lines *A18* and *A115* and the *RD1*, *WR1* lines from the Main processor and the data lines *A20* to *A27*, the address lines *A28* and *A215* and the *RD2*, *WR2* lines from the Display Processor. The switch and potentiometer settings that the operator sets are read into the Display Processor thru J2 then the Display processor writes out to J2 the display information for the multiplexed displays on the Display board (50000). This information is also sent to the Dual Port Ram. Then when the Main processor requests it is put on it's data lines so that the information can be dealt with. U29 pin 16 is a 1 millisecond clock which triggers an interrupt */INT1* to the main processor causing it to read the panel pots and perform other tasks every millisecond. (Not every thing is done every millisecond, but 32 tasks are scheduled in a queue and every thing gets taken care of eventually.)

The main processor U22 talks to the motor processor U3 (on the power board) and the Display processor U33 over a serial data link. It transmits on the *TXD* (transmit data, pin 11) line (J1 pin 7) and receives on the *RXD* (receive data, pin 10) line (J1 pin 15). The *TXD* line also goes to U11 which drives the fiber optic interface J15. If a problem exists on the serial bus between U22 and U33 on the main board and U3 on the power board, the main processor will shut down with a fault code 1, 2, or 190-193 (most likely fault code 1).

MAIN BOARD 50010 (Cont.)

Please refer to the schematic 50012 for references.

□ MICROPROCESSOR (Cont.):

The DISPLAY microprocessor U33 fetches the program instructions from EPROM U35. The EPROM is jumper selectable to be either 32K bites (27C256) or 64K (27C512) with JP3. The lower 8 bits of the address bus is multiplexed with the data bus. The lower address bus, pins 39 - 32 (AD20 - AD27,) is routed to the left side of U34 and decoded with the ALE2 (Address Latch Enable) line. The outputs (right side) of U34 containing only address information now, are applied to the EPROM program memory chip U35 along with the high order 8 bits of the address bus. The high 8 bits of the address bus come directly from U33 pins 21 - 28 (A28 - A215) without need of decoding. The program instruction is placed on the multiplexed AD bus when the Program Store ENable PSEN2 signal is LO, as controlled by the processor, the instruction is read into the processor, U33.

U33 the display processor causes an update of the front panel LED displays at a 1666 Hz rate. This translates into a total refresh rate of about 62 Hz.

The Display processor also controls the D/A that controls the exhalation valve. This is done with the Data that is passed across the J16 connector to the power board from the P1 port pins 1 thru 8.

□ PAL WATCHDOG CIRCUIT:

The PAL IC, U25 is enabled at pin 3 and data is written to and read from it. If the correct sequence of events occur, then a pulse is output at pin 14.

U28, top half checks if the pulses are faster than .45 milliseconds. The bottom half detects pulses slower than 99 milliseconds. The time constants are set by the resistors R61, R62 and capacitors C58, C60 connected to U28. If the pulses are too fast, U28, top half never times out, and pulses stop coming out of pin 5. If the pulses are too slow, or if they stop because they are too fast, then U28, bottom half times out. Both conditions cause U28 pin 5 to go LO causing a VENT INOP condition, and pin 12 to go HI sending a RESET to the processor and I/O chips. A slow condition will latch, and the only way to reset it is to remove power. A fast condition will restart itself. NOTE: The processor will not run without a PAL even if the watchdog timer is disabled because it reads data from the PAL, and if it is not responding then the processor stops, and waits for the VENT INOP condition to occur after writing a fault code 3, 4, or 5.

OVERVIEW OF THE 8400ST VENTILATOR SYSTEM OPERATION

MAIN BOARD 50010 (Con't.)

Please refer to the schematic 50012 for references.

□ A/D CONVERTER CIRCUITS:

The circuits convert the front panel pots and pressure signals from the transducers and the generated DC voltages from analog voltages to digital numbers that the processor can use. The inputs are *pots* R50 to R62 (pins J3-16 to J3-40 even), *Vpot* J3 35,37, & 39 *System Pressure* J4-2, *Machine Pressure* J4-4, and *Proximity Pressure* J4-6, *-VBI* J17-6, *2.5VREF* from U3 pin 2 *FLOW PRESSURE* J17-3 and *+12V_REF* J1-19. The same inputs are seen at both A/D converters, this forms a dual redundant system. RP1,RP2,U13,U14,U15,U16 and U21A make one analog to digital interface circuit. RP3,RP4,U17,U18,U19,U20 and U21B make up an identical analog to digital circuit. During normal operation data is read and checked against each other, if a close match is not found, a fault code (32, 33, 42, 43, 44, 52, 53, 54, 62, 63, 64, 73, or 78) is sent and the ventilator goes into a Vent Inop condition. This also happens if any input is in overrange or an open circuit condition (fault codes 40, 41, 50, 51, 60, 61, 70, 75, 80, 85). Open wipers on the potentiometer are detected by an overrange condition due to pull up resistors R58, R59, RP5 and RP6 (fault codes 30, 31). RP1, RP2, RP3, RP4, C14-29, C30-45 form noise filters for the A/D inputs. D6,D7,D8 & D9 limit the Machine and Proximity pressure to 5.1VDC. This is to keep the A/D from going overrange.

The A/D's are controlled by the main processor thru the chip decode signals and switch decode signals (CSADC, CSMUX1, & CSMUX2). The inputs are selected one at a time by the analog switches (U13,U14,U17 & U18) and are converted into digital data. This is done thru the switch decoders U15 and U19. Data is sent back and forth over the AD10 - AD17 bus, and controlled by the Main processor using CSADC, /RDATD1, /RDATD2, WR1, and A10 lines between the A/D converters U16, U20 and the MAIN processor U22. Stable DC voltages are seen at the inputs (left side) of U13, U14, U17 and U18, but after passing through U13, U14, U17, and U18, no sense can be made of the signals observed at the output with the lowly oscilloscope. A more sophisticated logic analyzer would be needed to decode the bidirectional data. An ohmmeter to check continuity and shorts is the only tool that can help you here. When a Vent Inop condition occurs the failed switch condition and signal level are held until power is removed. You can check between the two circuits and compare switch selections to see if they are the same and also voltage levels both into and out of the switches and into the A/D's.

MAIN BOARD 50010 (Con't.)

Please refer to the schematic 50012 for references.

□ REFERENCE CIRCUITS:

U1 generates both the *5VA* and *VPOT* references. The 8 Volt supply, from the transducer board 9680, is the reference for these voltages. R1, R2, and R3 divide the 8 Volts into approximately 5.00 Volts for the *5VA* supply, and 4.97 volts for the *VPOT* supply. The *5VA* is the reference supply for the A/D converters. All voltages are measured against this supply. The processor measures the *VPOT* supply during its power up self test, and if it is not proper, compared to the *5VA*, then it shuts itself down with a fault code 80-87. U1 constitutes two buffer amplifiers, so that the voltages at input pins 3 and 5 are *5VA* and *VPOT* respectively at the outputs.

U3 is the 2.5 Volt reference supply. It is powered by the *Va* supply. It is the reference for the fault monitor circuit and if it is not correct the processor will halt with a fault code 70-78.

□ FAULT MONITOR CIRCUITS:

U2 is a square wave oscillator whose output pin 3 is sent to U4 pin 5. If the *5V*, sensed by R18 & R19 is within proper limits the square wave is passed to output pin 2. That is when the left side of R17 is HI, the voltage at pin 5 is greater than the 2.5 Volt reference at pin 4, and when the left side of R22 is LO then the voltage at pin 5 is less than the 2.5 Volt reference. This causes the output pin 2 to toggle up and down, and if the *5V* goes too high or too low, then the output gets stuck HI or LO (this is a fail condition). The *5VA* is tested the same way at pin 7 of U4 (R22 and R23). The *VA* is tested the same way at pin 9 of U4 (R26 and R27). The *VM* is tested the same way at pin 11 of U4 (R30 and R31). Pin 13 of U4 is applied to a differentiator circuit (AC coupled) so that if pulses are present at pin 13, then they are coupled through capacitor C6, rectified into DC by D1 and D2, and charges capacitor C7 causing pin 7 of U6 to be HI. If the pulses cease, then C7 discharges through resistor R35 causing pin 7 to be LO and also the output pin 1 to be LO. A LO signal here results in a Vent Inop condition.

The *VPOT* current is monitored by U6 at pin 5. This detects an open front panel pot by sensing a reduction of *VPOT* current. The trimmer on the 50000 display board is set so that the *VPOT* load is 650 Ohms. If a pot opens then the voltage at pin 5 of U6 becomes greater than the 8 Volts at pin 4, this causes the output pin 2 to go LO.

OVERVIEW OF THE 8400ST VENTILATOR SYSTEM OPERATION

MAIN BOARD 50010 (Con't.)

Please refer to the schematic 50012 for references.

□ FAULT MONITOR CIRCUITS (Con't.):

This output is connected together with the J1-5 Exhalation Valve switch and the *system pressure* J5-4 comparators U5 pins 1 (Hi limit test), and 14 (Lo limit test). This node has a 1 second time constant set by R34 and C8 so that momentary fluctuations of *Vprs* because of ventilator breathing does not cause Vent Inops. At C8 the bottom half of the fault monitor system from pin 1 of U6 is connected so that all fault conditions are fed to U6 pin 9 without the time delay. If U6 pin 14 is LO then a fault exists. This signal is sent to U31 pin 6. At U31 if either a reset condition (HI at pin 7) or fault condition (LO at pin 6) exists, then the output pin 5 will be LO clearing both halves of U28 forcing a *VENT INOP* and *RESET* condition.

□ ALARM CIRCUIT:

The alarm circuit is powered by a supercap C9 (*Vb*) and is charged from the 5V supply through R42 and D3. This maintains an alarm when power is lost. A latch is formed by the two top parts of U8, and the latch is enabled when the 5V goes low at R43. The alarm silence switch *ALM SLNC SW** resets and latches the alarm OFF at J3-14, left side of R85 only after power is turned off. This is connected to pins 11 of U40 and its output pin 13 signals the processor that the switch has been pressed. An alarm generated from the processor *ALARM** at R47 or a *VENT INOP** at R48 (pins 2, 1 of U8) will cause U8 pin 3 to go HI. A HI signal at pins 6 and 7 of U7 will drive the alarm ON. Pressing the alarm silence switch with the power on does not latch the alarm OFF but signals the processor to turn the *ALARM** HI (off), later the processor will turn off the silence function and its LED and set *ALARM** LO, turning the alarm back on. The *VENT INOP** signal at R47 also goes to U9, then to U8 where the output signal is applied to Q1 to form a power driver to the Vent Inop LED on the front panel. This LED is made to blink by timer U10 pin 3, flashing on and off.

TROUBLESHOOTING

If a problem exists on the bus between U11 and U8, U9, and U10, the processor will not run or it will shut down with a fault code 105 through 108. The Eprom is checked with both a checksum and a CRC (cyclical redundancy check) at power on, if these both pass you can be assured that the Eprom is good (fault codes 6, 7 if not). The internal RAM memory of the processor is checked on power up also (fault codes 100-103 indicate a faulty processor).

TROUBLESHOOTING (Con't.)

The only way to troubleshoot the address bus and make sense out of it with a scope is to plug in an Eprom filled with NOP instructions into the U24,35 socket. Then the processor acts like a binary counter. Signals can be observed at the U24,35 Eprom address lines. Starting with *A0*, and continuing to *A15*, each address line is half the frequency of the line before it. Note that *A0 - A7* are not solid hi levels, but are a burst of HI going pulses at the clock frequency due to the *ALE* decoding. Each burst will have twice the number of pulses than the line before it. *A8 - A15* will look normal, 50% duty cycle square waves.

These IC's also contain some RAM memory inside, and this is tested upon powering up the ventilator (fault codes 105 - 108).

POWER BOARD 50020

Please refer to the schematic 50022 for references.

POWER SUPPLIES

The power comes in from the Transformer through J9 and then through the AC / DC switch at J8 through fuse F1. The AC or DC goes to the bridge rectifier at J5. The DC voltage gets filtered by capacitors C4, and C5. This voltage is called *V_m* and powers the valve motors. This goes to D3 and then more filtering by C7 and C8 and is applied to Q1, the 5V regulator mounted on the rear of the casting. C9 is its output filter, and it is sent to the main board by J14-7,8. A preregulated voltage is sent to the fault monitor on the main board by R1 at J1-9 (*5V_{unreg}*) to sense early dropout of the 5V supply.

V_a voltage is generated from the AC (or DC) line by D1, D2 and filtered by C2. This is sent to the main board at J14-1,2.

-*BIAS SUPPLY* is generated from the +5v supply and U2. U2 is a positive to Neg voltage generator.

OVERVOLTAGE CIRCUIT

U1 senses an overvoltage condition on the 5V supply through resistors R2 and R3. Upon overvoltage, U1 triggers SCR Q2 and shorts out (crowbars) the *V_m* supply (input to 5V regulator). This blows the fuse F1.

OVERVIEW OF THE 8400ST VENTILATOR SYSTEM OPERATION

POWER BOARD 50020 (Con't.)

Please refer to the schematic 50022 for references.

□ REFERENCE CIRCUIT:

U10 is the 2.5 Volt reference supply and it generates the 1.13 Volt reference. It also is used in the Exhalation drive circuit for voltage reference. The 2.5 volt reference is powered by the *V_m* supply. R19, R20 divide the 2.5 Volt from pin 2 of U10 into 1.13 Volts for the flow motor current reference supply.

Q4 and U8 are used to generate the VEXH voltage of 12vdc. It is monitored thru divider stage R17, R18 to J1-19 to the A/D circuits. This voltage will be shut down with a vent inop condition thru Q3 or by the processor U3 pin 14 if a failure is detected.

□ MICROPROCESSOR:

The clock signal is generated by the 12 Mhz crystal X1 and the microprocessor U3, pins 18, 19. The *RESET* pin 9 comes from the main board through J1-11.

The microprocessor fetches the program instructions from EPROM U5. The EPROM is jumper selectable to be either 32K bites (27C256) or 64K (27C512) with JP2. The lower 8 bits of the address bus is multiplexed with the data bus. The lower address bus, pins 39 - 32 (*AD30 - AD37*), is routed to the left side of U4 and decoded with the *ALE* (Address Latch Enable) line. The outputs (right side) of U4, containing only address information now, are applied to the EPROM program memory chip U5 along with the high order 8 bits of the address bus. The high 8 bits of the address bus come directly from U3, pins 21 - 28 (*A38 - A315*) without need of decoding. The program instruction is placed on the multiplexed *AD* bus when the Program Store ENable *PSEN3* signal is LO, as controlled by the microprocessor, the instruction is read into the processor, U3.

The motor processor talks to the main processor (on the main board) over a serial data port. It transmits on the *TXD* (transmit data, pin 11) line and receives on the *RXD* (receive data, pin 10) line. If a problem exists on the serial bus between U11 on the main board and U10, the main processor will shut down with a fault code 1, 2, 190-193.

POWER BOARD 50020 (Con't.)

Please refer to the schematic 50022 for references.

□ SAFETY SOLENOID:

The safety solenoid, connected to J10, can be turned off (vent condition) by the *RESETA* signal on J1-11, by the processor U3 pin 13, or by a power failure (it is normally open with no power applied). These signals are sensed at pin 1, 2 of U7 the power driver. D5 provides turn off spike protection for U7.

The Purge solenoid is enabled with the *RESETA* signal also. The Purge solenoid is controlled by the Main processor thru J1-17.

□ FLOW MOTOR DRIVE CIRCUIT:

The Flow signals are output from U9 pins 3 and 11, and U6 output pins.

A315 is sent to U6, pin 1. This enables U6. This line, and the *WRite (WR3)* enable the processor to write data to the peripheral output chip, U9.

The Flow signals from U9 and U6 go to level translator ICs U11 and U12. Resistor pack RP1 act as pull ups on these lines. Power Drivers U11 and U12 form a switching "H" bridge for the motor phase coils. With this arrangement, current can be passed through in either direction of the coil (both plus and minus voltages can be applied to the motor phase). The power for the WHITE - YELLOW phase of the motor is supplied from *Vm* through the Q5 regulator at rear of casting. When the power is first applied to the motor about 10V is applied across the motor winding, as the current rises, it is sensed across current sensing resistor R29. U13 compares the 1.13 volt reference to the voltage across the 1.13 ohm R29. When 1 amp current is reached, U13 turns the voltage down by reducing the set voltage of Q5 through R27, and R26, maintaining the current at 1 amp. C26 acts as a noise filter, and C27 slows down the response of U13. The Q6 circuit functions identically (the RED - BLUE phase). When only one phase of the motor is on, bias current is removed through R31 so that the winding current that is on becomes approximately 1.5 amps. This is to increase the holding torque of the motor when only 1 winding is energized.

The *FLOW HOME* line comes from the optical sensor on the flow valve at J7-7 and goes to U3 pin 2.

OVERVIEW OF THE 8400ST VENTILATOR SYSTEM OPERATION

POWER BOARD 50020 (Con't.)

Please refer to the schematic 50022 for references.

□ EXHALATION VALVE DRIVE CIRCUIT:

CPU B (U33 pins 1-8) port P1 controls the D/A U15 on the Power Board thru connector J16. CPU B sends a digital signal from 00 to ff hex to the D/A U15. This causes a dc voltage into U14 causing a voltage between 0 and 5VDC to be felt at TP1. 2.5VDC is an idle or relaxed condition of the Exhalation Valve. 0v is closed and 5v is fully open.

The voltage at TP1 is then applied and mixed with the velocity coil feedback at U16 Pin 9. This is then changed into a signal at TP5 that will vary around 1/2 VEXH or approx. 6v. This is fed into the power driver U18 pin 1 which drives the linear exhalation valve. As the valve moves the Magnet causes an electrical charge to be sent back to U14 pin 2 which is a high gain amplifier as feedback to the drive signal.

The Velocity Coil feedback is DC coupled into U16 pin 5 to be mixed with the D/A voltage coming in. This closed loop system enables the valve to move smoothly and properly from the fully closed to fully open positions.

The Power Driver U18 is set up as a Differential Amplifier. In a pushpull arrangement (Pins 5 and 8). One side will be above 6v and the other side below 6v.

The I BOOST signal from CPU C U3 pin 3 is fed to the base of Q7 to turn it on and ensure that the exhalation valve has enough current to stay closed during the inhalation cycle. and it is Released during exhalation cycle.

The exhalation valve switch passes through the board from J6-5 to J1-5, and the exhalation home *EXH HOME** line comes from the optical sensor on the exhalation valve at J6-3 and goes to U9.

The Exhalation Home line is read in at U3 pin 1

TROUBLESHOOTING

Fault codes 10-28, 210-218, 110-112, 119 are valve positioning problems, please see code list.

TROUBLESHOOTING (Cont.)

The only way to troubleshoot the address bus and make sense out of it with a scope is to plug in an Eprom filled with NOP instructions into the U5 socket. Then the processor acts like a binary counter. Signals can be observed at the U5 Eprom address lines. Starting with A30, and continuing to A315, each address line is half the frequency of the line before it. Note that A0 - A7 are not solid hi levels, but are a burst of HI going pulses at the clock frequency due to the ALE3 decoding. Each burst will have twice the number of pulses than the line before it.

The motor processor checks internal RAM (fault codes 220-223), and its Eprom (fault code 236).

TRANSDUCER BOARD 9680

Please refer to the schematic 9682E for references.

REFERENCE:

Three terminal regulator U3 provides the 8V reference to the main board at J4 - 9, 10, 11 derived from the Va supply (J4 - 14, 15, 16). Capacitors C5 and C4 are the filters.

VPROX AND VMACH TRANSDUCERS:

PT1 and PT2 pressure transducers are powered by the 8V reference and produce an output of 1.0 Volt per PSI. At 0 PSI, the output voltage is 1.0 Volts, and at 5 PSI, the output voltage is 6 Volts. At pin 3 of PT1 and PT2 the output voltages are as follows for calibration purposes:

0 cm H ₂ O	= 1.00 ± 0.05 Volts
60 cm H ₂ O	= 1.85 Volts
140 cm H ₂ O	= 2.98 ± 0.10 Volts

If the zero and gain are not in spec., then the transducer board will not be able to be calibrated. If the transducers don't match closely, a fault code 9 is generated on the main board.

The output of PT1 is offset by the R1 adjustment to 1.250 Volts out at 0 cm H₂O pressure and amplified by U1, with gain adjusted by R2 to 2.424 Volts at 60 cm H₂O as measured at J4-6.

The output of PT2 is offset by the R3 adjustment to 1.250 Volts out at 0 cm H₂O pressure and amplified by U2, with gain adjusted by R4 to 2.424 Volts at 60 cm H₂O as measured at J4-4.

OVERVIEW OF THE 8400ST VENTILATOR SYSTEM OPERATION

TRANSDUCER BOARD 9680 (Con't.)

Please refer to the schematic 9682E for references.

VPRS TRANSDUCER:

PT3 is an unamplified strain gage transducer with an output of 2.6 mV per PSI or 40 mV at 15 PSI. These voltages are proportional to the 8V supply. R9 is an offset adjustment, adjusted at 20 PSI. The other half of U1 and U2 form a differential amplifier for PT3. At J4-2, the voltage out will be 1.25 V \pm 0.3 at zero PSI and 4.38 V \pm .06 at 20 PSI (if the 8V supply is exactly 8.000 Volts).

DISPLAY BOARD 50000

Please refer to the schematic 50002 for references.

LED'S:

Seven segment display LED's are multiplexed by the Display microprocessor U33 on the main board. Pins J2-19 to J2-33 odd are the inputs to the segment driver U1 for the upper row of displays. Pins J2-35 to J2-49 odd are the inputs to the segment driver U2 for the lower row of displays. R7 through R22 are current limiting resistors for the segment drivers. The displays are scanned at a rate of about 62 Hz.

U3, U4, and U5 are octal decoders to decode the digit driver information. U6 thru U11 are the transistor array drivers for the digits. The discrete LED's for Patient Effort, Sigh, Low Gas, Apnea, Insp. Time, Breath Rate, Minute Volume, and Silence are driven using U12 independently from J2-14 to J2-30 even. The Battery LED is powered directly from the DC supply, and the Vent Inop LED is powered directly from the main board. The Green Power LED is powered from the 5V supply.

POT'S AND SWITCHES:

Pots R50 through R62 are the front panel controls, and the ends are connected in parallel and are powered from the VPOT supply from the main board. R39 and R40 are an adjustment to adjust the total VPOT load to 650 \pm 5. This is so that the main board can detect an open pot. The wipers are connected to J3-16 to 40 and go to the main board. Open wipers are detected by an overrange condition due to pull up resistors on the main board.

DISPLAY BOARD 50000 (Con't.)

Please refer to the schematic 50002 for references.

□ POT'S AND SWITCHES (Con't.):

Switches SW1 - SW7, Silence, Reset, Sigh, Manual Breath, Mode Select Inspiration Hold and Mode are connected to the main board through J3-1 to J3-14.

Q1 Hexfet is used to turn the displays off during a loss of power inop.

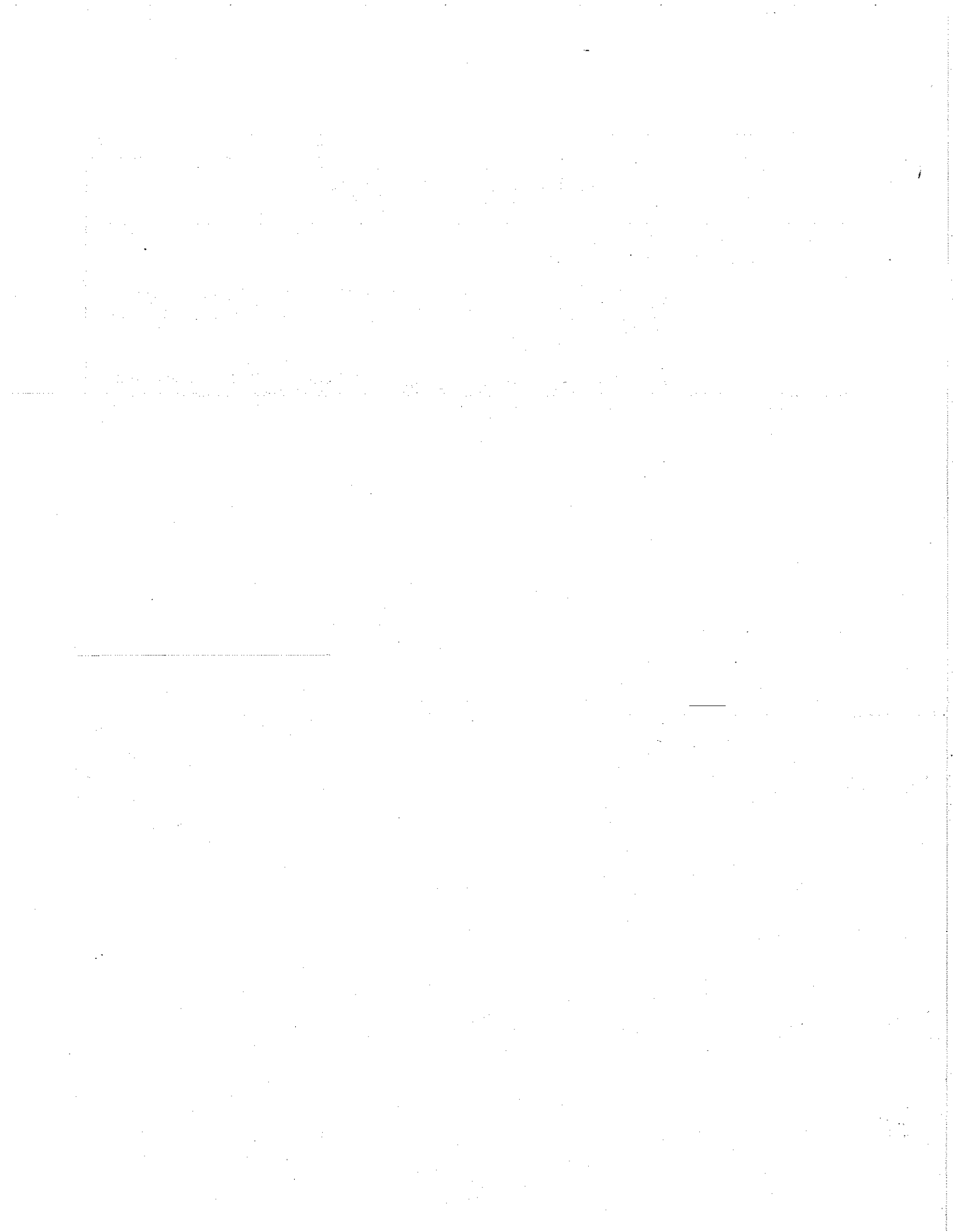

SECTION 6

Warnings, Cautions and Notes

SECTION 6

WARNINGS, CAUTIONS, NOTES

The 8400ST Volume Ventilator should be operated by trained, qualified medical personnel under the direct supervision of a licensed physician. Before clinical application, the WARNINGS, CAUTIONS, and NOTES should be read and understood.

WARNING:

CONDITIONS MAY EXIST THAT COULD ADVERSELY AFFECT THE OPERATOR OR PATIENT.

CAUTION: Conditions may exist that could damage the ventilator or other pieces of equipment.

NOTE: A specific point is made to assist the operator in understanding the equipment.

WARNINGS:

■ DO NOT USE VENTILATOR IN THE PRESENCE OF FLAMMABLE ANESTHETICS AS A POSSIBLE EXPLOSION HAZARD EXISTS.

■ THE 8400ST VOLUME VENTILATOR SHOULD NOT BE USED UNTIL A "PERFORMANCE CHECK" HAS BEEN COMPLETED (SECTION 14).

■ A 8400ST VOLUME VENTILATOR WHICH IS NOT FUNCTIONING OR DOES NOT MEET MANUFACTURER'S DESIGN SPECIFICATIONS SHOULD NOT BE USED UNTIL ALL NECESSARY REPAIRS HAVE BEEN MADE. CONTACT YOUR BIRD DISTRIBUTOR OR BIRD PRODUCTS CORPORATION FOR REPAIR.

■ ALWAYS OPERATE THE 8400ST VOLUME VENTILATOR WITH CLEAN/ DRY MEDICAL GRADE GASES.

■ ELECTRICAL SHOCK HAZARD; DO NOT REMOVE THE VENTILATOR COVER. REFER ALL SERVICING TO A BIRD TRAINED TECHNICIAN, YOUR

BIRD DISTRIBUTOR OR BIRD PRODUCTS CORPORATION.

■ WHEN THE 8400ST VOLUME VENTILATOR IS CONNECTED TO A PATIENT, IT IS RECOMMENDED THAT A TRAINED CLINICIAN BE IN ATTENDANCE AT ALL TIMES, TO TAKE PROMPT ACTION SHOULD AN ALARM OCCUR.

■ FOR CONTINUED PROTECTION, REPLACE THE FUSE OR FUSES IN THE POWER ENTRY MODULE ONLY WITH ONE OF IDENTICAL TYPE AND RATING.

■ A FLASHING "OFF" IN THE LOW PEAK PRESSURE ALARM DISPLAY INDICATES THE ALARM LIMIT HAS NOT BEEN PROPERLY ESTABLISHED. ALWAYS ENSURE THAT THE LOW PEAK PRESSURE ALARM LIMIT AND OTHER CRITICAL ALARMS (i.e. HIGH PEAK PRESSURE ETC.) ARE PROPERLY ESTABLISHED BEFORE LEAVING THE PATIENT UNATTENDED.

WARNINGS, CAUTIONS, NOTES

WARNINGS: (Continued)

■ BEFORE PATIENT APPLICATION, "PRESSURE TEST" THE PATIENT CIRCUIT INCLUDING HUMIDIFIER HEATER MODULE FOR POSSIBLE AIR LEAK DUE TO MISASSEMBLY OR DAMAGED COMPONENTS. (SEE SECTION 14- PERFORMANCE CHECK)

■ IT IS RECOMMENDED THAT P/N 10172, THE PATIENT BREATHING CIRCUIT KIT BE USED WITH THE 8400ST VOLUME VENTILATOR. THIS CIRCUIT HAS BEEN VERIFIED ACCEPTABLE FOR USE WITH THE 8400ST.

■ THE OPERATION OF EACH ALARM AND ALERT FUNCTION, BOTH AUDIBLE AND VISUAL, SHOULD BE VERIFIED DAILY.

■ CONSULT A PHYSICIAN ON PROPER FRACTIONAL CONCENTRATION OF INSPIRED OXYGEN (FI_{O_2}). MONITOR THE INSPIRED GAS WITH A CALIBRATED OXYGEN ANALYZER AND OBTAIN SERIAL BLOOD GAS DETERMINATIONS.

■ MONITOR OXYGEN CONCENTRATIONS WITH AN ACCURATE OXYGEN ANALYZER WITH HIGH AND LOW (FI_{O_2}) ALARMS TO BE ASSURED THAT THE DESIRED FI_{O_2} IS BEING DELIVERED.

■ WHEN USING THE 3800 MICROBLENDER IN CONJUNCTION WITH THE 8400ST VOLUME VENTILATOR, ALWAYS CONNECT THE VENTILATOR/BLENDER HOSE ASSEMBLY (P/N 09520) TO THE AUXILIARY OUTLET OF THE BLENDER. THE BLENDER AUXILIARY OUTLET CONNECTION WILL ENSURE ACCURACY OF OXYGEN CONCENTRATION DELIVERY

AT THE LOWER FLOW SETTINGS OF THE VENTILATOR.

■ BIRD PRODUCTS CORPORATION DOES NOT RECOMMEND THE USE OF BREATHING CIRCUIT TUBING WITH AN INSIDE DIAMETER OF LESS THAN 3/4" (1.91cm), LARGE BORE TUBING ONLY.

■ THE EXHALATION VALVE DIAPHRAGM SHOULD BE CHECKED DAILY FOR EXCESSIVE WEAR OR PERFORATION AND REPLACED WHEN NECESSARY. OTHERWISE IMPROPER PATIENT VENTILATION MAY OCCUR.

■ MANUAL BREATH CAPABILITY IS NON-FUNCTIONAL DURING VENTILATOR INOPERATIVE CONDITION.

■ UNDER CASES OF EXTREMELY HIGH MINUTE VENTILATION DEMANDS, THE PRIMARY BLENDER OUTLET PORT CAN BE USED TO EXTEND THE UNIT'S CAPABILITY. HOWEVER, O_2 CONCENTRATIONS WILL DRIFT OUT OF SPECIFICATIONS AT MINUTE VOLUME DEMANDS OF 6 LITERS OR LESS WHEN USING THIS PORT.

■ WHEN THE 8400ST VOLUME VENTILATOR IS CONNECTED TO A PATIENT, IT IS RECOMMENDED THAT THE LOW PEEP/CPAP ALARM ALWAYS BE SET TO A LEVEL, NOT TO EXCEED $3cmH_2O$, BELOW THE SENSITIVITY SETTING (EVEN WHEN PEEP/CPAP = $0cmH_2O$). PROPER ESTABLISHMENT OF THIS ALARM PROVIDES ANOTHER AUDIBLE/VISUAL INDICATOR SHOULD A PROBLEM OCCUR IN THE FLOW DELIVERY SYSTEM.

WARNINGS: (Continued)

■ ALL ELECTROMECHANICAL SYSTEMS ARE SUBJECT TO MALFUNCTION OR FAILURE FROM INTERNAL OR EXTERNAL CAUSES. TO GUARD AGAINST INSIDIOUS, UNDETECTED PERFORMANCE DEGRADATION THE VENTILATOR WILL DETECT AND ALARM VARIOUS CONDITIONS WHICH MAY CAUSE FAILURE OR SIGNIFICANT PERFORMANCE DEGRADATION. SOME CONDI-

TIONS (SUCH AS EXTREME POWER OR GAS PRESSURE VARIATION OR SYSTEM FAILURE) WILL FORCE THE VENTILATOR INTO A VENT INOP SHUTDOWN WITH AUDIO/VISUAL ALARMS. VENT INOP SITUATIONS WILL OCCUR! CLINICAL STAFF SHOULD BE PREPARED TO RESPOND WITH A WELL-REHEARSED PROCEDURE TO PROVIDE EMERGENCY VENTILATION.

CAUTIONS:

■ **Do not sterilize the 8400ST Volume Ventilator.** The internal components are not compatible with sterilization techniques.

■ Sterilizing which includes phenols, dimethyl ammonia chloride, chloride compounds and greater than 2% gluteraldehyde may cause damage to plastic components or control panel overlays. (See section 7 - Cleaning and Sterilization.

■ As with any other piece of medical equipment, care should be exercised when moving the equipment in the hospital environment.

■ Bird Products Corporation Bacteria Filters are compatible with steam autoclaving "ONLY". Do not wash, rinse, soak, pasteurize, ethylene oxide sterilize, or immerse the bacteria filters in liquid sterilizing agents.

■ **Do not insert any cleaning instruments (cloth, brush, pipe cleaner, etc) into the flow transducer.** Such action can seriously damage the flow element and result in inaccurate volume readings.

■ **Do not clean or dry with high pressure air gun under any circumstance.**

■ **Do not spray cleaning solution into louver openings or on front panel of the ventilator.**

■ ***Do not spray cleaning solution directly into exhalation valve assembly.**

■ ***Do not spray cleaning solution directly into flow transducer receptacle.**

■ ***Do not allow cleaning solution to pool on exhalation valve shaft or poppet.**

■ ***Do not allow cleaning solution to pool in flow transducer**

*Repeated use of the cleaning agent can cause build-up of residue on critical components of the ventilator, possibly affecting operation, if care is not exercised in the cleaning procedure.

NOTES:

■ Federal law restricts this device to sale by or on the order of a physician. The Volume

Ventilator is a restricted medical device intended for use by qualified personnel under the direction of a qualified physician.

WARNINGS, CAUTIONS, NOTES

NOTES: (Continued)

■ **Tidal Volume Indicator Flashing** - The operator has attempted to set a tidal volume too large for the peak flow setting and breath rate that have been selected. In response, the ventilator has limited the tidal volume proportionately to the established breath rate and peak flow, then notifies the clinician of this incompatible setting by flashing the tidal volume indicator. The limited tidal volume (flashing display) is the actual volume delivered.

■ **Peak Flow Indicator Flashing** - The operator has attempted to set a peak flow that is too high for the tidal volume selected. In response, the ventilator has limited the peak flow to a value that is acceptable for that tidal volume, then notifies the clinician of this incompatible setting by flashing the peak flow indicator. Limited peak flow (flashing display) is the actual flow delivered.

■ **Back Up Breath Rate Flashing** - A) The operator has attempted to set a breath rate that is too high for the tidal volume and flow settings. In response, the ventilator has limited the Back Up Breath Rate setting to the number in the flashing display. B) The operator has attempted to set the Back Up Breath Rate below the primary Breath Rate control setting. In response, the ventilator has increased the setting to the current primary Breath Rate control setting as indicated in the flashing display. However, the Back Up Breath Rate can be set to 0.

■ **Excessive Volume/Flow Limit** - In the event of a patient circuit disconnect while in the SIMV/CPAP mode, the system will provide maximum flow for a brief period in an effort to maintain the PEEP level. This could exceed the flow capacity of the oxygen blender and/or gas supply system resulting in a Ventilator Inoperative due to low system gas pressure. To avoid this situation, the unit will automatically reduce the flow to 40 lpm after 2.5 liters has been delivered in the inspiratory phase. This restriction will not apply to Sigh breaths. However, under conditions of a pressure supported time limited breath, the unit will auto-

matically reduce the flow to 20 lpm after 2.5 liters has been delivered.

■ When "I" Time exceeds "E" Time, the I:E Ratio "LED" will flash every 3 seconds, giving visual indication of the inverse state.

■ When the pressure support inspiratory time limit of 3 seconds is exceeded, the pressure support setting display will flash.

■ **Power up self test** - subsequent to initiating power to the ventilator (On/Off switch) a 5 second test is automatically conducted. During the test the following occurs:

1. Power "LED" turns "ON" and an audible alarm is briefly sounded
2. Front panel LED's segmentally display in unison
3. Microprocessors verify communication
4. Flow control valve returns to "Home" position and exhalation valve opens
5. Second audible alarm briefly sounds
6. Front panel displays illuminate
7. Ventilator begins to operate

■ **Selected vs Displayed Tidal Volume** - It is important to note that the 8400ST will accurately deliver volume controlled or volume assisted breaths within $\pm 10\%$ of the set value. It is also important to note that the measured volume, as displayed in the monitors section, will be accurate to within $\pm 5\%$ of the exhaled volume.

■ When the ventilator is not in use, it is recommended that the supply sources be disconnected from the unit, so that the 10-12 lpm bleed from the 3800 MicroBlender does not continue to consume supply gas. This is important if the 8400ST is in the transport configuration.

NOTES: (Continued)

■ This control sets the pressure level above PEEP. The total patient pressure equals PEEP + Pressure Support.

■ Pressure Support in the 8400ST has a preset 3 second inspiratory time limit. (See Description of Alarms in Section 3.)

■ When the airway pressure sensing port becomes blocked, the 0.05 to 0.1 lpm Purge Flow causes the manometer pressure to rise to 100 cmH₂O. The pressure seen on the manometer is not patient airway pressure. Approximately 10 seconds from the "CIRC" alarm notification, the safety solenoid opens and pressure is

relieved. Once the pressure is relieved back to baseline +3 cmH₂O, the ventilator resets and attempts to cycle again. If the blockage is not resolved, the process will repeat until corrective action has been implemented.

■ Back panel switch must be in the DC (ALT PWR Source) position.

■ If an inspiration (mechanical or spontaneous) is not detected within the Apnea Interval setting the breath rate will display zero, the apnea alarm will be initiated and Apnea Back Up ventilation will begin.

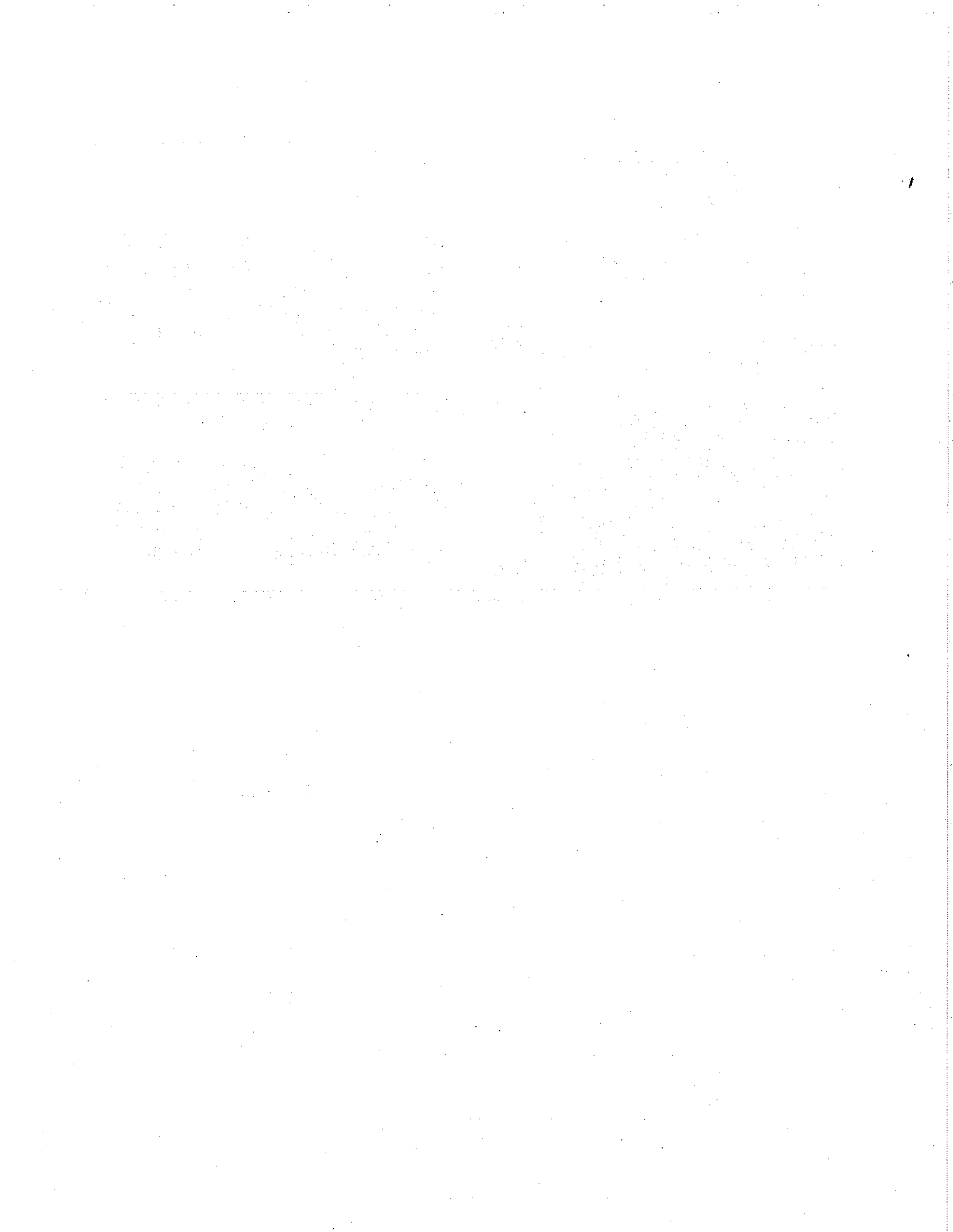

SECTION 7

Cleaning and Sterilization

THE UNIVERSITY OF CHICAGO

PHYSICS DEPARTMENT

PHYSICS 435

SECTION 7 CLEANING AND STERILIZATION

■ VENTILATOR

The exterior of the 8400ST Volume Ventilator may be wiped clean with an appropriate bactericidal or germicidal agent. Care should be exercised not to allow the liquid agent to pool in areas on the ventilator (primarily the front panel), so as to minimize the potential for the liquid to penetrate to the inside of the ventilator.

- **DO NOT** use harsh abrasives on ventilator.
- **DO NOT** immerse ventilator in liquid sterilizing agents.
- **DO NOT** sterilize ventilator.
- **DO NOT** allow bactericidal or germicidal agents to pool in flow transducer receptacle on front of ventilator.
- **DO NOT** spray cleaning solution into louver openings on ventilator.
- ***DO NOT** spray cleaning solution directly into exhalation valve assembly.
- ***DO NOT** spray cleaning solution directly into flow transducer receptacle.
- ***DO NOT** allow cleaning solution to pool on exhalation valve shaft or poppet.
- ***DO NOT** allow cleaning solution to pool in flow transducer.

*Repeated use of the cleaning agent can cause build-up of residue on critical components of the ventilator, possibly affecting operation, if care is not exercised in the cleaning procedure.

■ FLOW TRANSDUCER

The flow transducer can be cleaned by flushing with a gentle stream of water or agitating it in a solution of soap and water.

The flow transducer can be sterilized by liquid agents, heat pasteurization, autoclave or ethylene oxide gas.

- **DO NOT** insert any cleaning instrument (cloth, brush, pipe cleaner, etc.) into the flow sensor.
- **DO NOT** use a high pressure gas nozzle to dry the sensor.

■ BREATHING CIRCUIT

(See page 4-3 for diagram)

The ventilator breathing circuit, not including the humidifier module (P/N 03210 or 03210C) and autoclavable filters, may be submerged in liquid agents, ethylene oxide or steam autoclaved to sterilize.

The main flow bacteria filter is compatible with steam autoclave **ONLY**.

NOTE: For additional information on cleaning and sterilization of the 8400ST Volume Ventilator System, please refer to the following literature:

L1001- Heated Humidifier Instruction Manual
L1008- 3800 MicroBlender Instruction Manual

■ EXHALATION VALVE ASSEMBLY AND FLOW TRANSDUCER RECEPTACLE

Care should be exercised in cleaning the exhalation valve assembly and the flow transducer receptacle on the 8400ST Volume Ventilator. Please follow the instructions outlined below, when cleaning these critical components.

1. Apply topical solution to a clean soft cloth and wipe exposed surfaces. An evaporative solution (i.e alcohol) is recommended.
2. Visually inspect all surfaces (internal and external) to ensure that all cleaning solution has been removed.

SECTION 8

Maintenance Service Policy

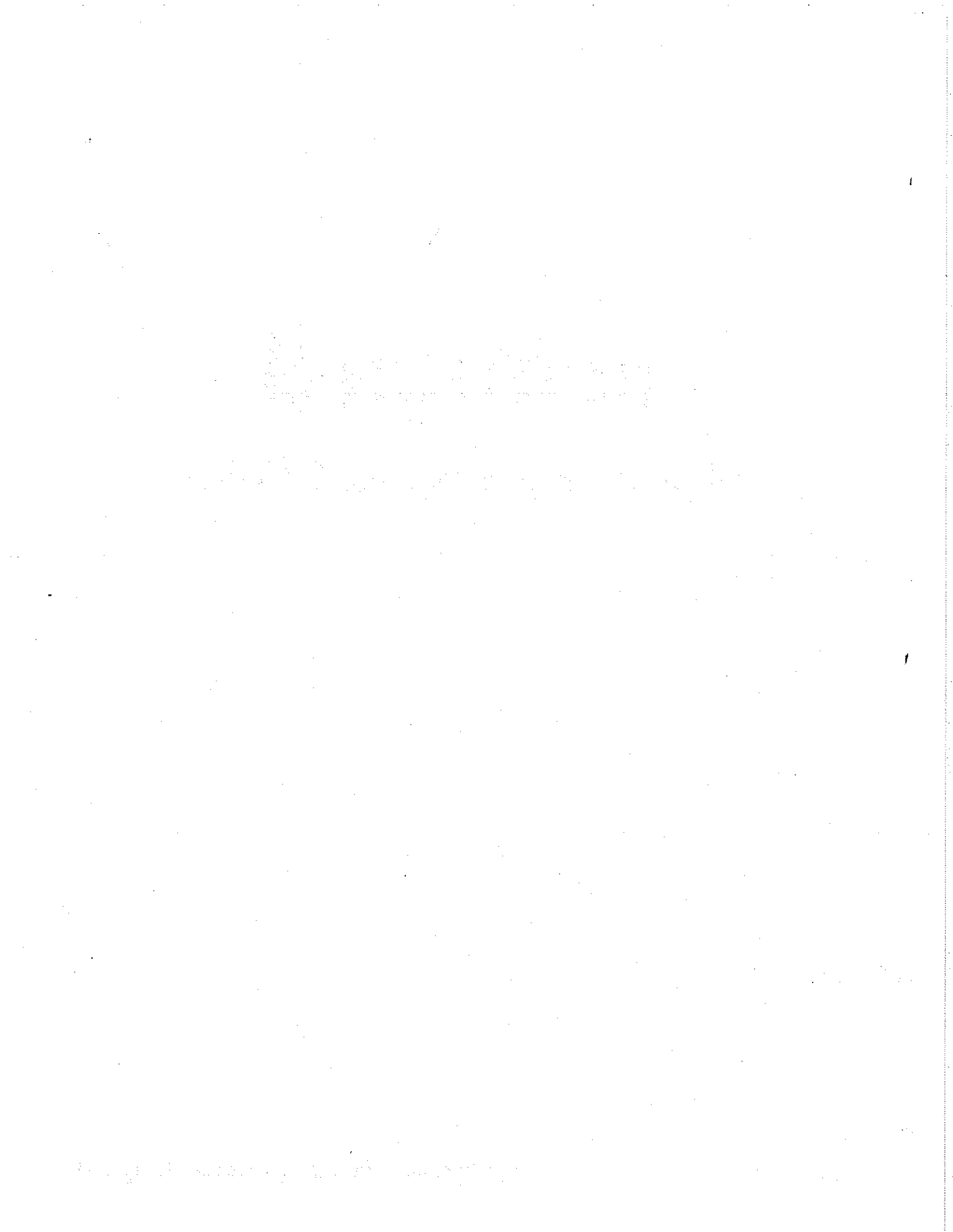

SECTION 8 MAINTENANCE AND SERVICE

WARNING:

A 8400 VOLUME VENTILATOR WHICH IS NOT FUNCTIONING OR DOES NOT MEET THE MANUFACTURER'S DESIGN SPECIFICATIONS SHOULD NOT BE USED UNTIL ALL NECESSARY REPAIRS HAVE BEEN MADE.

Bird Products Corporation equipment has been designed to provide the maximum amount of utilization with minimum amount of maintenance. When determining the desired frequency of maintenance many variables must be considered.

- Frequency and length of use.
- Cleanliness of compressed air source.
- Use of an air inlet water trap/filter.

CAUTION: The 8400ST Volume Ventilator should be serviced and /or calibrated by a Bird Products Corporation trained service technician.

The 8400ST Volume Ventilator, like other pieces of Health Care equipment will require routine maintenance over a period of time. Refer to the following for recommended maintenance intervals.

■ 8400 RECOMMENDED MAINTENANCE SCHEDULE

<p>Every 1000 Machine Hours</p>	<p>Ventilator Inlet Filter- remove and examine the internal surface of the inlet filter for foreign material. If filter appears to be dirty or discolored, replace with new coalescing filter replacement element (P/N 06146).</p> <p>CAUTION: Dirty inlet filter can reduce the machine's working pressure and subsequently result in a "Ventilator Inoperative" condition.</p>
<p>Every 3000 Machine Hours</p>	<p>Machine, Airway, and Flow Transducer calibration -Verify transducer calibration to ensure accuracy of measurement (see page 8-2). If accuracy varies more than specified, contact your Bird distributor or Bird Products Corporation for repair.</p>
<p>Every 5000 Machine Hours</p>	<p>Bacteria Filter - The main flow filter should be replaced once each year or more often if the resistance to flow through filter exceeds the maximum allowable limit (see page 8-3).</p> <p>Main Flow Bacteria Filter: 2 cm H₂O @ 60 lpm.</p>

MAINTENANCE AND SERVICE

Every 15,000 Machine Hours	A complete machine maintenance will be required at a minimum of once every 15,000 machine hours. Contact your Bird distributor or Bird Products Corporation for service.
-----------------------------------	--

■ TESTING AND VERIFICATION INSTRUCTIONS FOR ALL TRANSDUCERS

NOTE: The following test must be conducted after the ventilator has been continuously running for at least 30 minutes with the top cover in place to stabilize temperature variations.

1. Depress and hold the Select button and turn on the ventilator. Verify that the flow valve "Homes" within 5 seconds and does not move thereafter.

After valve "Homing", a series of dots will appear on the ventilator's monitor display window. Release the Select button. All 7 segment LED display must be off except for monitor display window and the Backup Breath Rate. (BBR).

SOFTWARE REVISION VERIFICATION:

The four-digit number, representing the Main PC Board software revision level, is displayed in the monitor window, BBR display is number one (1).

2. Activate the Select button. BBR display is number 2. A four-digit number representing the Power PC Board software revision level will appear in the monitor window.

3. Activate the Select button. BBR display is number 3. A four-digit number

representing the Display PC Board software revision level will appear in the monitor window.

4. Activate the Select button. BBR display is number 4. A four-digit number representing the PAL PC Board software revision level will appear in the monitor window.

5. Activate the Select button. BBR display is number 5. This is the Flow Transducer Off set reading, and it should read 103 ± 50 cmH₂O in the monitor window.

6. Activate the Select button. BBR display is number 6. The Airway Pressure will appear in the monitor window. Without the Breathing circuit, the airway pressure should read $0.0 +1.00/-0.50$ cmH₂O.

7. Activate the Select button. BBR display is number 7. The Machine pressure will appear in the monitor window. Without the Breathing circuit, the machine pressure should read 0.00 ± 2.00 cmH₂O.

8. Activate the Select button. BBR display is the number 8. The System pressure will appear in the monitor window. The pressure should read 20.0 ± 0.5 PSI.

9. Activate the Select button once more and verify that all seven segment LED's and associated decimals illuminate except for Vent Inop and Battery.

MAINTENANCE AND SERVICE

10. Activate the Select button once more and the ventilator should function normally.

NOTE: If the transducers need to be recalibrated, refer to Section 14 steps 3.0 through 6.0.

NOTE: Ensure manometer reads zero with ventilator OFF prior to bacteria filter resistance test.

■ **Main flow bacteria filter resistance test** - Attach inspiratory limb of breathing circuit directly to ventilator outlet. Remove expiratory limb of breathing circuit, then connect bacteria filter onto expiratory side of the patient "Wye." Observe the proper flow direction. Adjust mode control knob to "Assist/Control", set Tidal Volume at

2000 ml's, Breath Rate at 12 bpm and Peak Flow to 60 lpm. Turn ventilator "ON" and observe peak reading on manometer.

Duplicate test with filter removed from circuit. Should the values recorded differ by 2 cmH₂O or more, then replace filter.

NOTE: Ventilator will go into a Low Peak Pressure Alarm condition, unless alarm is turned "OFF" but this will have no influence on the test.

Bird Products Corporation will make available upon request, circuit diagrams, replacement parts, descriptions and calibration instructions to assist qualified technical personnel to repair units as designated by Bird Products Corporation as repairable.

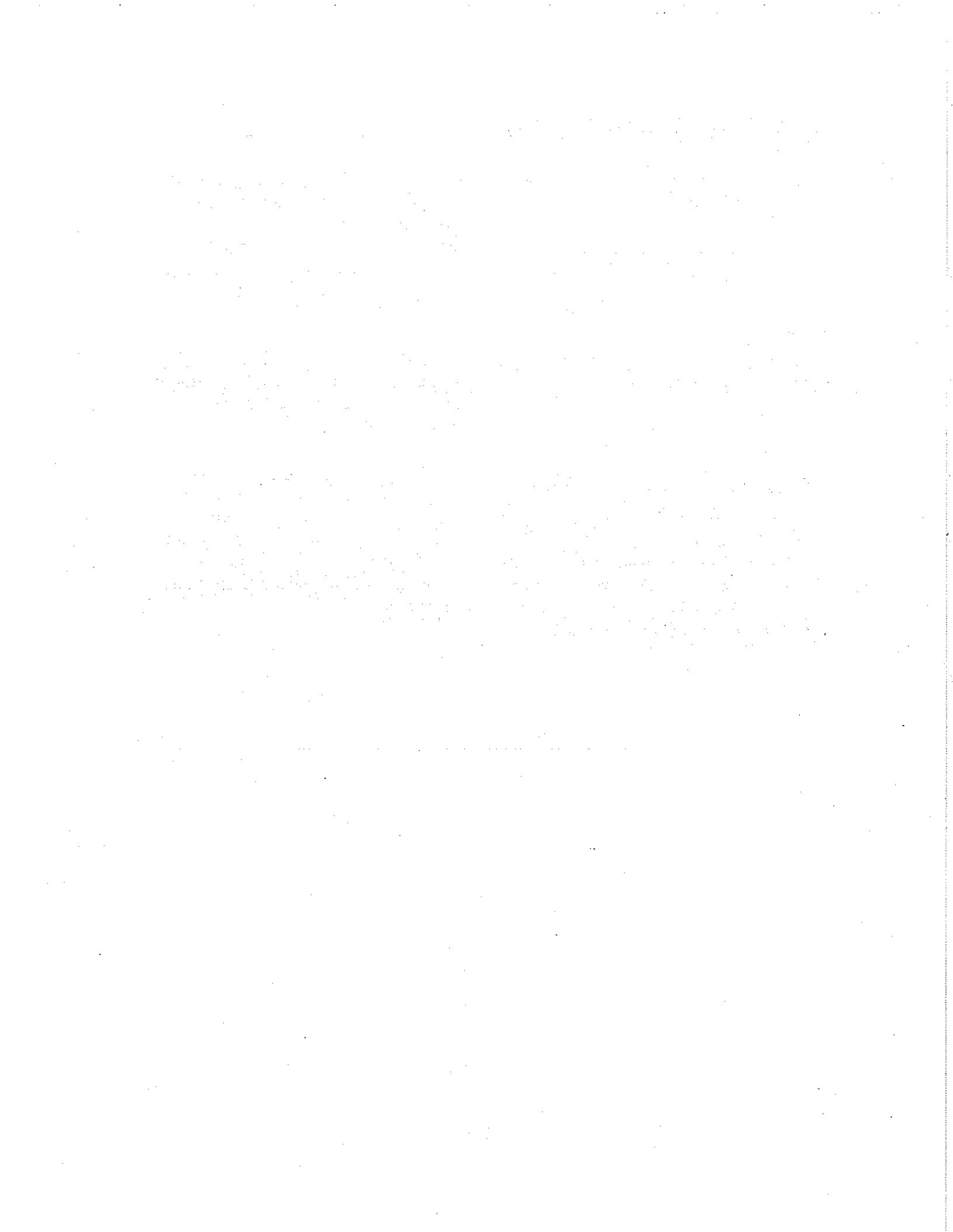

SECTION 9

8400ST Tools and Equipment List

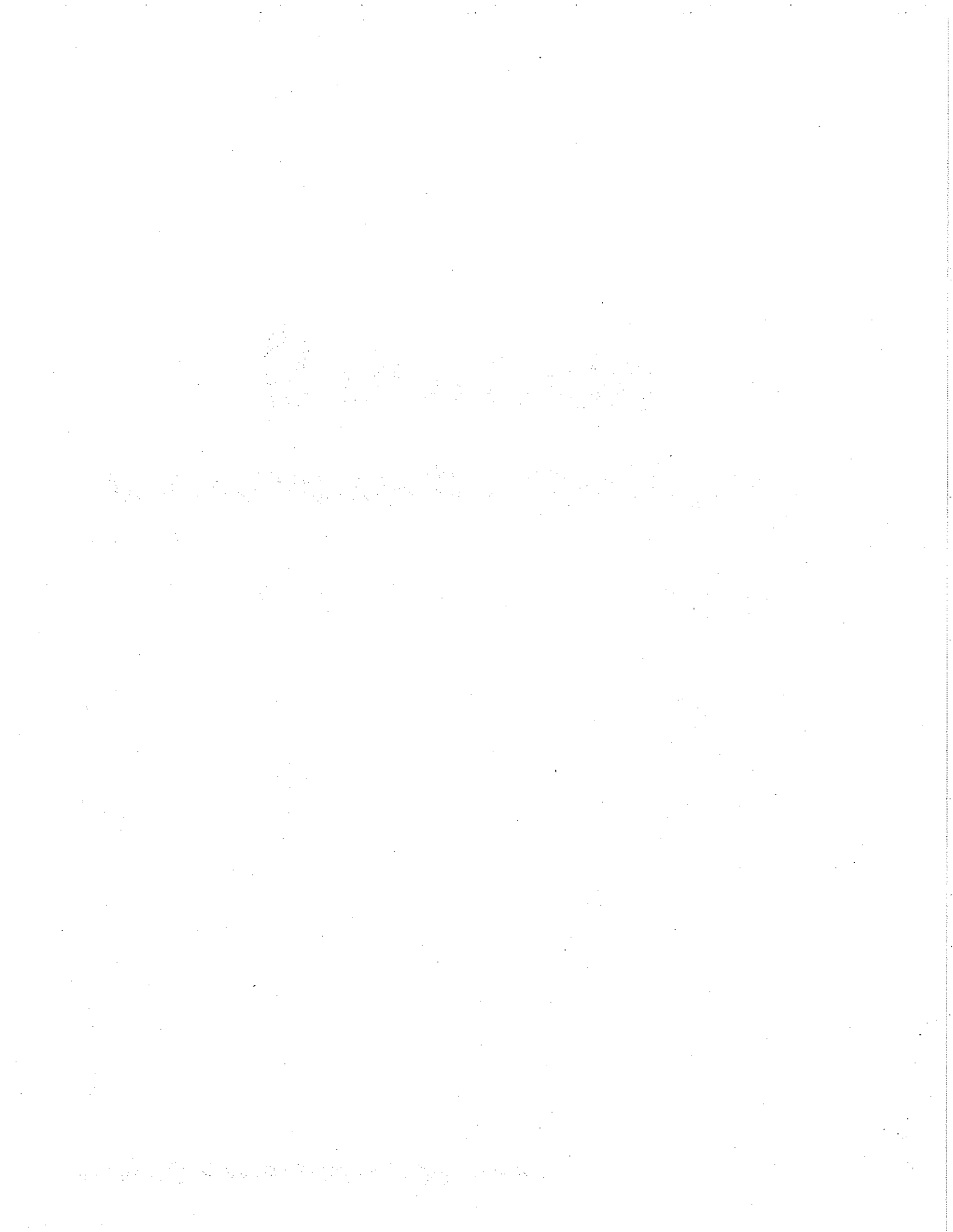

SECTION 9
8400ST TOOLS AND EQUIPMENT LIST

■ **8400ST 15,000 HOUR OVERHAUL – RECOMMENDED TOOLS AND EQUIPMENT**

1.0 Common Tools (Not available from Bird Products Corporation.)

Nutdrivers – (deep socket): 1/4", 5/16", 11/32", 3/8", 1/2", 7/16"
Open End Wrenches: 1/2", 7/16", 9/16", 5/8", 11/16"
Allen Hex Socket Driver Set No. 99-85-40 Xcelite or equivalent: 3/16", 3/32", *7/64", *9/64", and *5/32" Allen wrenches [*Ball end with 7" (18 cm) long shank]
Common screwdriver (slotted) - 8" long shank
#2 Phillips screwdriver - 8" long shank
Long thin needle nose pliers
Diagonal cutter
Trimpot adjustor
Stopwatch

2.0 Special Bird items required for the testing and calibration which may be obtained from Bird Products Corporation under the following part numbers:

Part No.	Description
00042	Lubricant
00066	Elbow
00077	Inline Pressure Manometer
00358	1/8" Tube Connector
00631	Lubricant
01233	22 mm Male x 15 mm Female, 2 each
01741	Connector 4.5 mm x 1/8" tubing, required to seal the water feed opening
02187	22F x 22M x 15F, Connection, 2 each
03010R	BHH Heating Module
03234	Corona Dope
03389	8400ST Pressure Transducer Test Harness
15127	Replacement Kit 8400ST
03884	Vibre-Tite Thread Locking Compound
03414	6400ST Service Tool Kit consisting of: <ul style="list-style-type: none"> • P/N 03415, Fixture Assembly, regulator bypass • P/N 03416 Fixture Assembly, pressure test - flow valve • P/N 03426 Safety Solenoid Removal/Assembly Tool\
03800	Hi/Low Flow MicroBlender
03913	Connection Assembly Jumper
04124	7.5 mm Tapered Plug - plugs BHH temperature sensing port in patient "Wye"
08929	Alternate Power Source (DC) Cable Assembly

8400ST TOOLS AND EQUIPMENT LIST

2.0 (Continued)

Part No.	Description
09220	Flowmeter 0 - 15 LPM
09520	Blender Hose
10172	Patient Circuit
09531	Corrugated Hose 30" smooth bore with cuffs to fit 22.0 mm O.D. fittings or its equivalent
10234	Flow Transducer Test Harness
10233	Prox/Purge Test Housing

3.0 Special equipment, tools not made available by Bird Products Corporation:

Torque screwdriver 0 - 100 inch/ounce <ul style="list-style-type: none"> • $\frac{7}{64}$" Allen driver • Adapter $\frac{5}{16}$" hex to $\frac{1}{4}$" square
Torque wrench 20 - 100 inch/pounds <ul style="list-style-type: none"> • $\frac{5}{32}$" Allen, $\frac{3}{8}$" drive female
Digital voltmeter
0 - 30 PSIG Precision pressure manometer + .05 PSIG accuracy - .1 or .2 PSIG increments
Standard test lung: <ul style="list-style-type: none"> • Rigid compliance 20 ml/cmH₂O + 5% • Bottle filled with 22 pounds (10kg) fine grade copperwool
Flow Tube 0 - 10 LPM, 0.1 LPM increments
Endotracheal tube 7 mm I.D x 20 cm long non cuffed with 2 adapters 7 mm x 15 mm
Thermometer 50° - 120°F (9 - 48° C) with 2 temperature probes
Pressure Transducer - 20 to + 140 cmH ₂ O accuracy + .5 at 0 cmH ₂ O to + 2 cmH ₂ O at full scale
Variable transformer 1 - 140 volts or 1 - 260 volts
12 - 16 VDC power supply 5 amp minimum
4 function calculator - must have square root/memory
Anti-static mat to cover worktable
Anti-static wrist strap
Anti-static mat ground connecting cable
Anti-static D.I.P. remover (for EPROMS and IC)
Anti-static bags
R.T.V. clear silicon, adhesive sealant or equivalent
8 Ltr volume spirometer \pm 2% accuracy or its equivalent
Slant tube manometer

■ **KIT, SERVICE TOOL P/N 03414**

This assembly consists of the following:

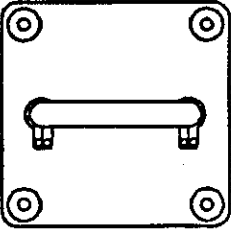
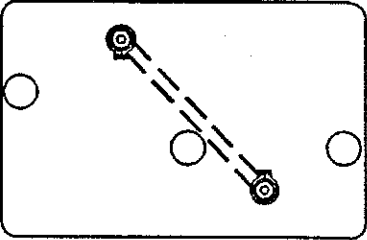
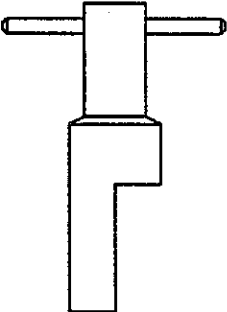
P/N	Description	Qty
<p data-bbox="358 474 451 506">03415</p> 	<p data-bbox="781 474 1230 516">Fixture Assy, Regulator Bypass</p>	<p data-bbox="1373 485 1390 516">1</p>
<p data-bbox="358 854 451 886">03416</p> 	<p data-bbox="724 854 1289 896">Fixture Assy, Flow Valve Pressure Test</p>	<p data-bbox="1373 865 1390 896">1</p>
<p data-bbox="358 1314 451 1346">03426</p> 	<p data-bbox="841 1314 1170 1356">Tool, Solenoid Wrench</p>	<p data-bbox="1373 1325 1390 1356">1</p>

8400ST TOOLS AND EQUIPMENT LIST

03913

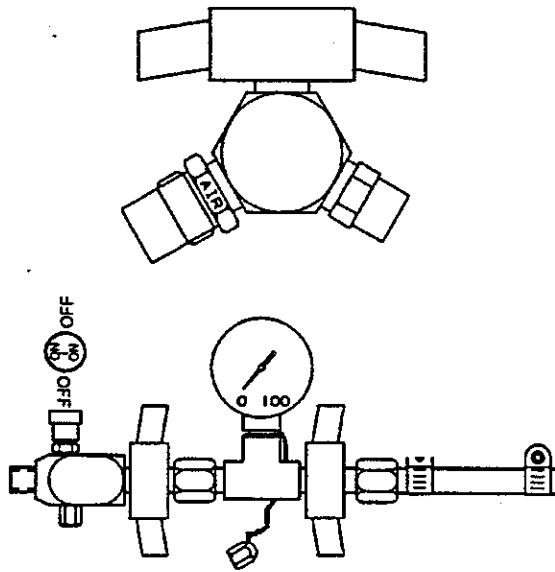

Test Hose Assembly

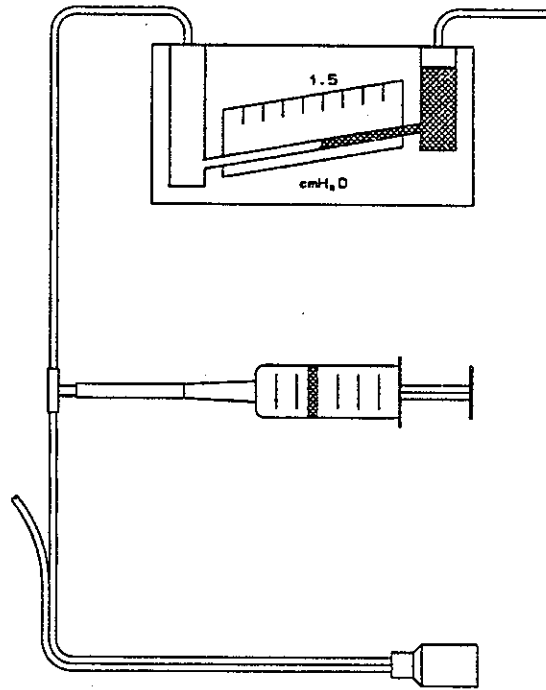

Slant Tube Manometer

10233

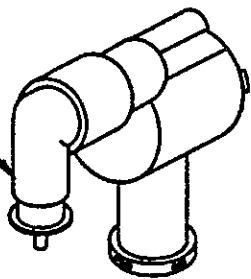

10234

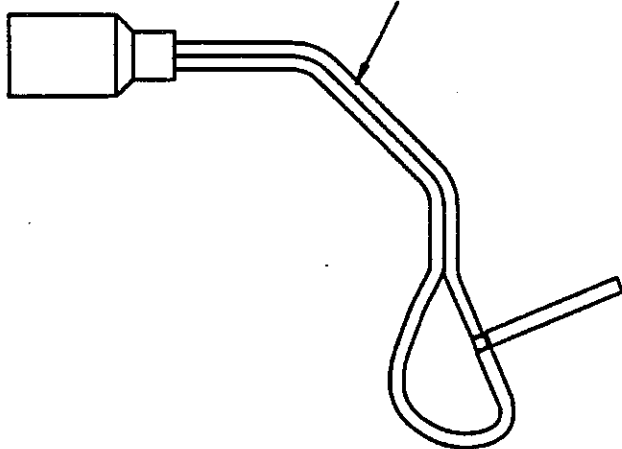

**P/N 10233 Proximal/Purge Test Housing
P/N 10234 Flow Transducer Test Harness**

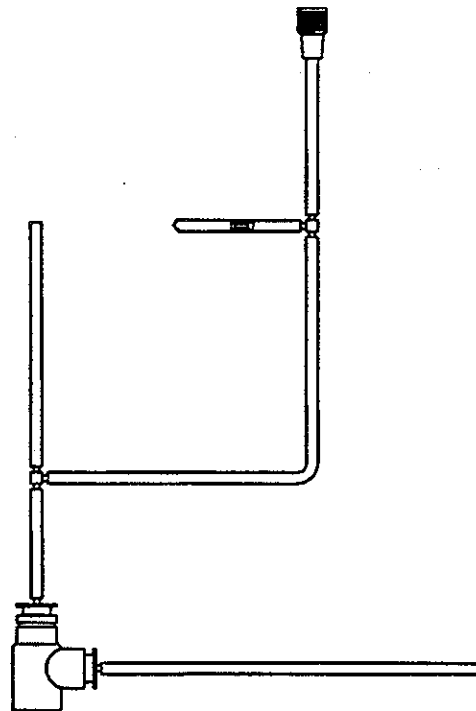

P/N 03389 Pressure Transducer Test Harness

SECTION 10

Maintenance Kits

SECTION 10

MAINTENANCE KIT P/N 15127

■ 8400ST MAINTENANCE KIT INCLUDES:

P/N	Description	Qty.	P/N	Description	Qty.
00114	O-Ring, .117 x .040	4	09672	Insulator, TO-3	4
00138	O-Ring, .176 x .070	1	09712	Regulator, 2-25 PSIG	1
00274	O-Ring, .145 x .070	2	09740A	Valve, Flow Control Assembly 8400ST	1
03288	O-Ring, .551 x .070	1	09754	Safety Valve Assembly	1
03372	O-Ring, .72 x .103	3	10080	Tube Assembly Manometer Transducer	1
03373	O-Ring, .801 x .070	1	15349A	Exhalation Valve Assembly	1
03374	O-Ring, .364 x .070	2	15053	Manifold Flow Transducer	1
03375	O-Ring, .301 x .070 Silicone	2	15179	Kit, Fuse Overhaul	1
03516	Insulator Bridge Rectifier	1	20005	Body Exhalation Valve with Seal	1
03901	Tubing, 1/4" x 6" I.D. Reinforced	1	20097	Pad, Thermal Interface	2
04876	Plug Gauge Adjust	1	20107	Diaphragm	1
05038	Cable Tie Wrap	1	20191	Gasket, .875 OD, Flow Transducer	1
06146	Element, Filter	1	20292	Gasket, .396 OD, Flow Transducer	1
06194	O-Ring, P/N 09672 Filter	1	15053	Manifold, Flow Transducer Assembly (Solenoids)	1
06195	Bowl, P/N 09762 Filter	1	50060A	PCB Assembly Flow Receptacle	1
07803	Cable Tie Wrap	10			
07849	O-Ring, .313 x .051	1			
08880	Gasket, Flow Control	1			
08934	Tube Assy, Reg Exhaust	1			
08963	O-Ring, .924 I.D. x .103	1			
09603	Connection Elbow Safety Valve/Manifold	1			
09632	Gasket, Manifold	1			

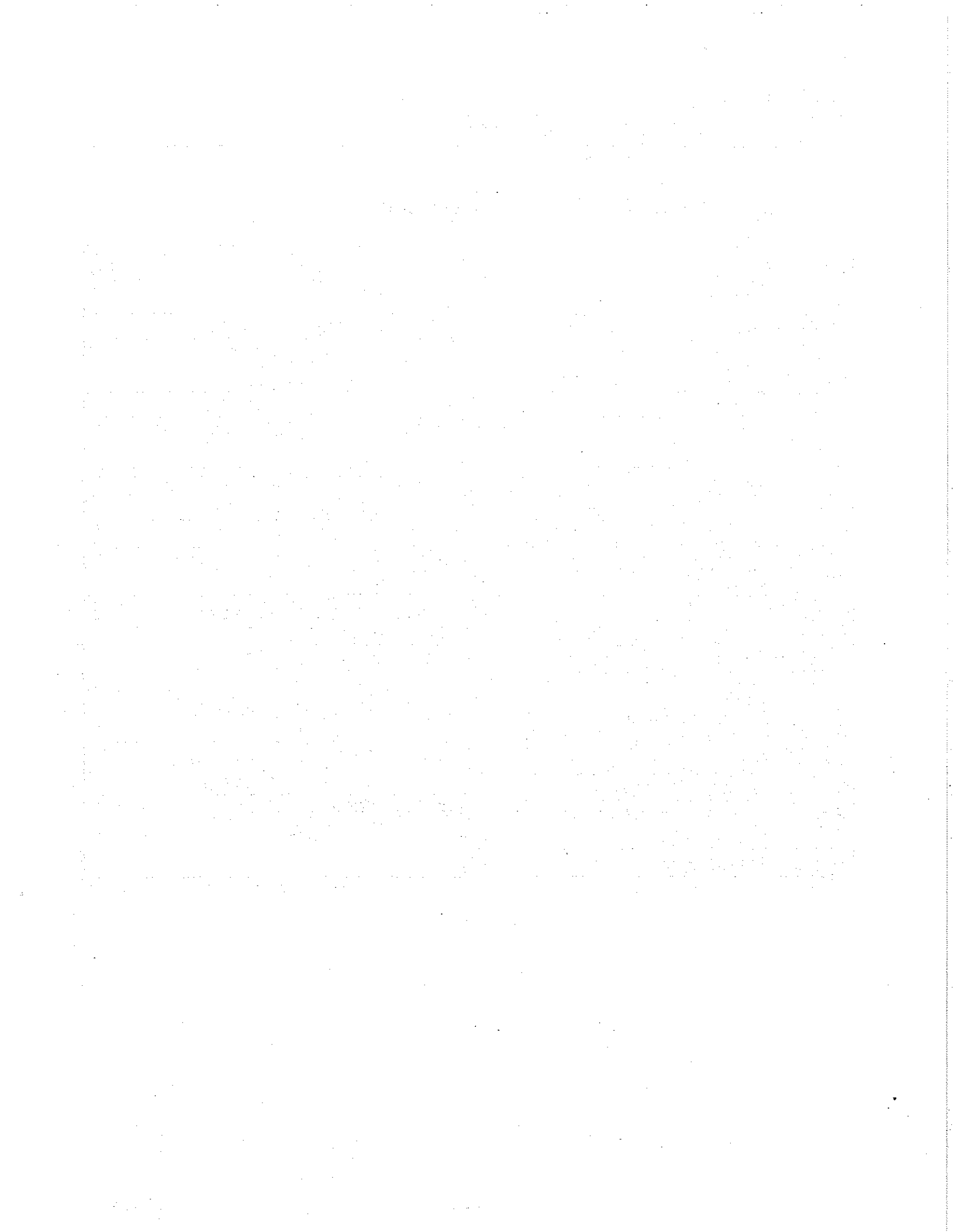

SECTION 11

Disassembly

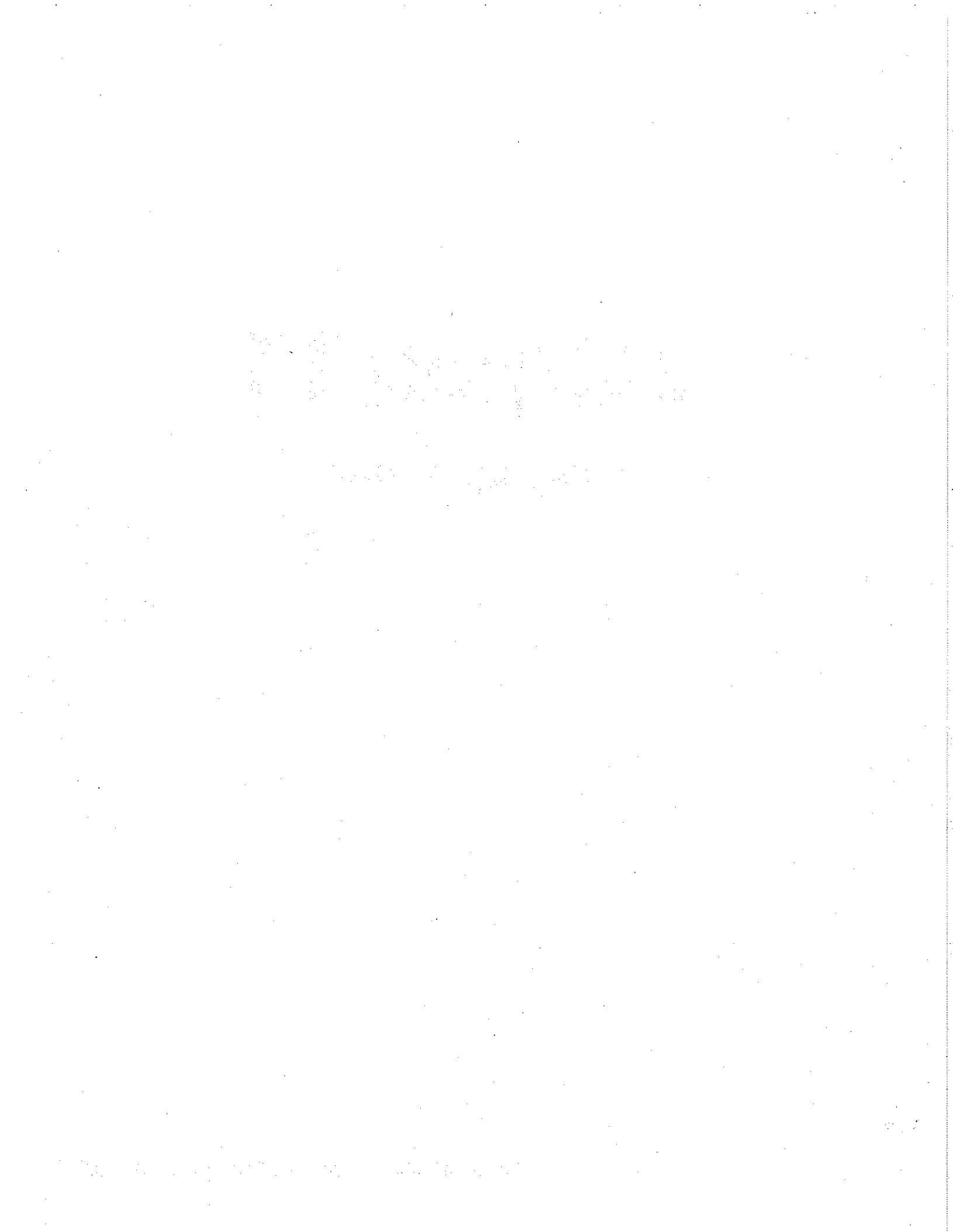

SECTION 11 DISASSEMBLY

■ INTRODUCTION

The Bird 8400ST Volume Ventilator has been designed to provide the maximum amount of utilization with a minimum of maintenance. The 8400ST Volume Ventilator should be serviced only by Bird Products Corporation trained, Hospital/Dealer Service Technicians.

Before servicing or calibrating, the technician must be familiar with the design, operation, warnings, cautions and notes as explained in Section 6 of this manual.

A numbering system is utilized so that one can easily identify the steps involved with each operation.

If during Assembly and Operational Verification Procedure a suggested parameter is not met, refer to "Troubleshooting" instructions before proceeding with the next step.

CAUTIONS:

■ The work area must be Electro Static Discharge (E.S.D.) protected. The technician's work surface must be grounded before removing the top cover and while working on ventilator. All Printed Circuit Board assemblies (PCB) in the 8400ST have Integrated Circuits (IC) and can be severely damaged by static electricity. All PCB assemblies must be placed in anti-static bags after removal.

■ Always unplug power cord from electrical power source, wall plug, before removing top cover.
