

# Service manual Precision balances

## **KERN 572 / 573<sub>xx</sub>NM** Version 5.1 4/2009 GB

### **KB<sub>xx</sub>N(M) / DS** **FCB<sub>xx</sub>B / FKB (M)**





**KERN 572 / 573<sub>xx</sub>NM / KB<sub>xx</sub>N(M)**  
**DS / FCB<sub>xx</sub>B / FKB (M)**  
Version 5.1 4/2009  
**Service Manual**  
**Precision Balances**

---

---

**Table of Contents**

**1 Basic Information ..... 3**

**2 Introduction..... 4**

**3 Keyboard Description ..... 4**

**4 Mode – Menu ..... 5**

**5 Troubleshooting ..... 6**

**6 Adjustment ..... 7**

    6.1 Adjustment of non-verification balances.....7

    6.2 Adjustment of verification balances (KERN 573-NM; KB-NM; FKB-M) .....7

**7 Factory Menu ..... 8**

    7.1 How to Enter the Factory Menu .....8

    7.2 Display Contrast .....8

    7.3 Factory Adjustment .....8

    7.4 Automatic Linearity Adjustment.....9

    7.5 Manual Linearity Adjustment.....9

**8 Electronics ..... 10**

    8.1 Explanation and Connection of Main PCB ..... 10

    8.2 Layout of Main PCB ..... 11

# 1 Basic Information

## Grundlegende Hinweise

**The device must be repaired only by trained specialist staff or personnel with professional formation (such as a repair-specialist accredited by law concerning verification).**

**The service manual is obligatory for repair work.**

**After repair, original conditions of the device have to be restored.**

**Only original spare parts should be used.**

### **Instructions about conformity-evaluated scales:**

**Repair must be carried only at 100% compliance with the type approval.  
A violation of this specification will result in a loss of the type approval!**

**After successful repair the balance will have to be reverified before it can be used again in a statutorily regulated field.**

Das Gerät darf nur von geschultem oder beruflich ausgebildetem Fachpersonal (z. B. eichrechtlich anerkannter Instandsetzer) repariert werden.

Die Serviceanleitung ist bindend für Reparaturen.

Das Gerät muss nach erfolgter Reparatur wieder in den Originalzustand zurückversetzt werden.

Es dürfen nur Originalersatzteile verwendet werden.

### **Hinweis zu konformitätsbewerteten Waagen:**

Reparatur darf nur in 100% -iger Übereinstimmung mit der Bauartzulassung erfolgen. Ein Verstoß gegen diese Vorgabe führt zum Erlöschen der Bauartzulassung!

Nach erfolgreicher Reparatur muss eine Nacheichung erfolgen, um die Waage wieder im gesetzlich geregelten Bereich verwenden zu können.

## 2 Introduction





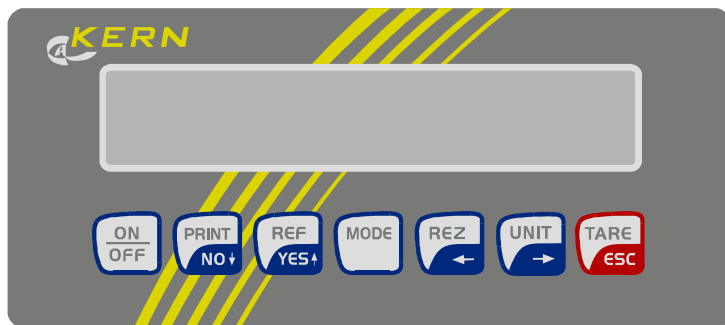

This service manual covers the 572, 573<sub>xx</sub>NM, KB<sub>xx</sub>N(M), DS, FCB<sub>xx</sub>B, FKB (M) series and is edited for the authorized servicing personnel.

Note all rights are reserved. Copying any part of this manual is prohibited without our permission.

## 3 Keyboard Description



### Keyboard

	ON / OFF
	Print weighing result <i>in MODE: No / descending</i>
	<b>in % and counting mode:</b> Form reference <i>in MODE: Yes / ascending</i>
	MODE configuration
	Formula weighing <i>in MODE: to left</i> <i>Change g-pieces</i>
	Unit changeover <i>in MODE: to right</i>
	Tare <i>in MODE: back in weighing operation</i>

# 4 Mode – Menu

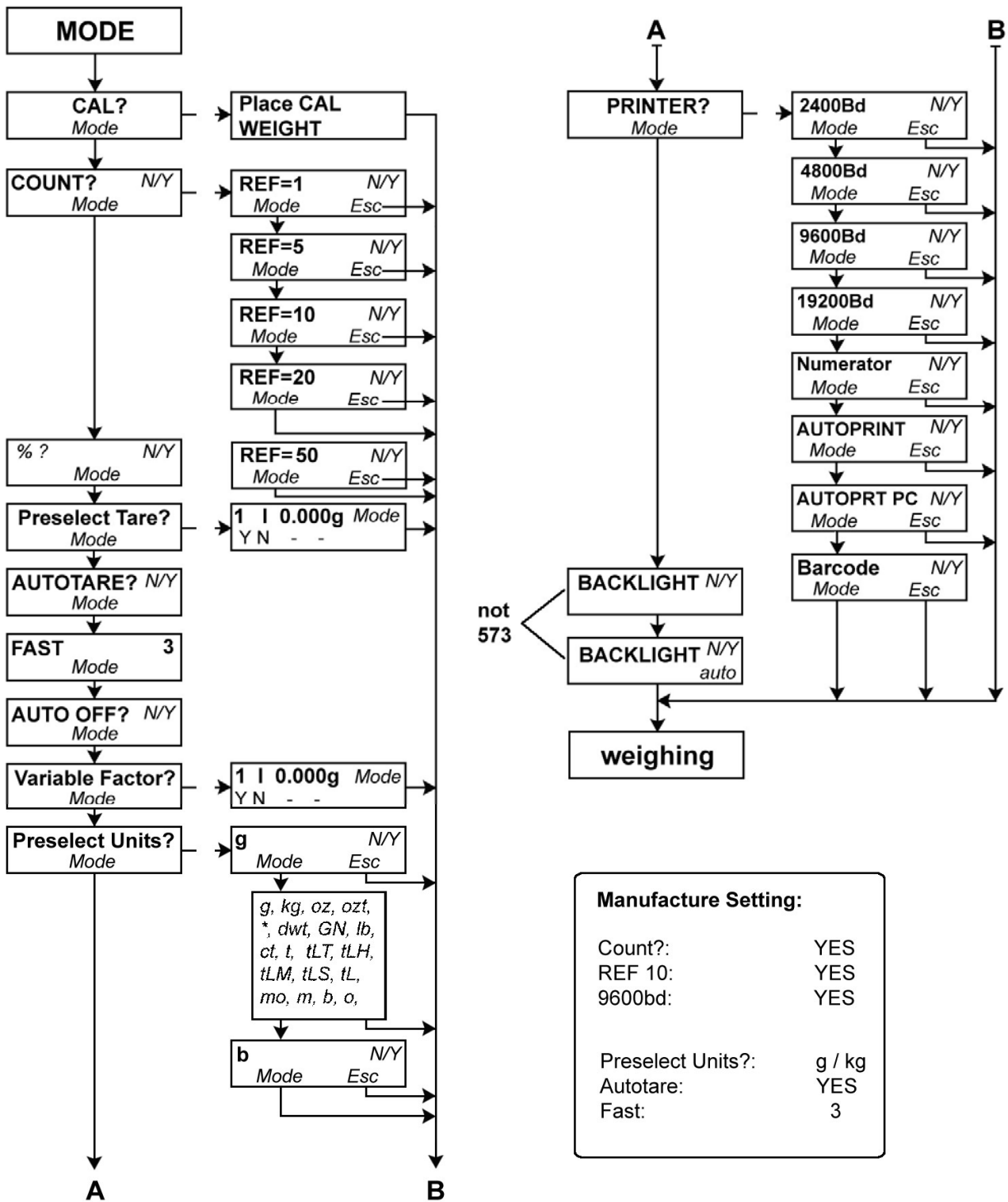

**Manufacture Setting:**

Count?:	YES
REF 10:	YES
9600bd:	YES
Preselect Units?:	g / kg
Autotare:	YES
Fast:	3

## IMPORTANT!

The modified settings - as well as the adjustment - must be stored when switching-off, via the ON/OFF button.

## 5 Troubleshooting

Interruption	Possible cause
==OVERLOAD==	<ul style="list-style-type: none"> <li>• Either the scale is overloaded or there is a mechanical defect</li> </ul>
= =====	<ul style="list-style-type: none"> <li>• Underload: Weighing range has been fallen short of</li> <li>• Mechanical defect or a defect in the main PCB</li> </ul>
<< .	<ul style="list-style-type: none"> <li>• In counting and % mode: part too light</li> </ul>
bat .	<ul style="list-style-type: none"> <li>• The rechargeable battery is empty and should be loaded</li> </ul>
Weight display is not illuminated.	<ul style="list-style-type: none"> <li>• The balance is not switched on.</li> <li>• The mains supply connection has been interrupted (mains cable not plugged in/faulty).</li> <li>• Power supply interrupted. .</li> </ul>
The weight display changes continually	<ul style="list-style-type: none"> <li>• Draught/air movement</li> <li>• Table/floor vibrations</li> <li>• The weighing plate is in contact with foreign matter.</li> <li>• Electromagnetic fields / static charging (choose different location/switch off interfering device if possible)</li> </ul>
The weighing result is obviously incorrect	<ul style="list-style-type: none"> <li>• The balance display is not set to zero</li> <li>• Adjustment is no longer correct.</li> <li>• Great fluctuations in temperature.</li> <li>• Electromagnetic fields / static charging (choose different location/switch off interfering device if possible)</li> </ul>

Switch the balance off if other error messages should appear and then switch on again. Contact the manufacturer if the error message does not disappear.

## 6 Adjustment

The balance must be adjusted at its place of installation before initial use and at regular intervals.

A warm-up time of about 4 hours is recommended for stabilisation.

Please use the recommended adjusting weight according to the technical data in the operating instruction.

### 6.1 Adjustment of non-verification balances

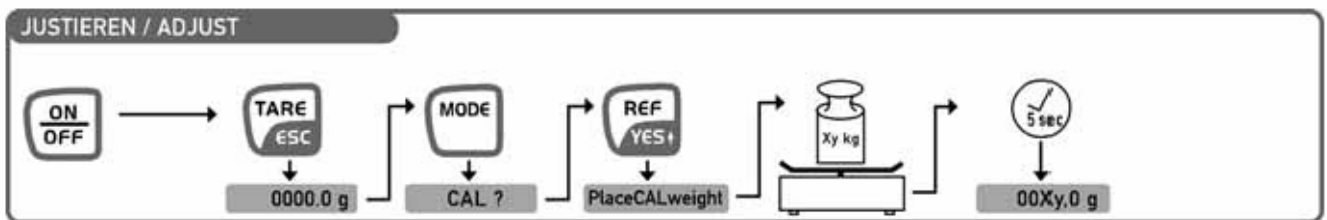

### 6.2 Adjustment of verification balances (KERN 573-NM; KB-NM; FKB-M)

Remark: The adjusting is only possible when not being blocked by the adjusting switch. The switch for this step is located at the bottom of the housing between the two turning feet.

<b>Switch to the right</b>	Adjusting function is released.
	This setting has to be selected before starting the adjusting.
	Executing the adjusting according to below procedure.
	After the adjusting has been completed successfully it is necessary to turn the adjusting switch to the left for blocking.
<b>Switch to the left</b>	Adjusting function is blocked.
	After the adjusting has been completed successfully the adjusting has to be blocked by switching to the left.
	The balance is now prepared for the procedure of verification.
	After the verification the adjusting switch has to be secured by a verification mark against access.

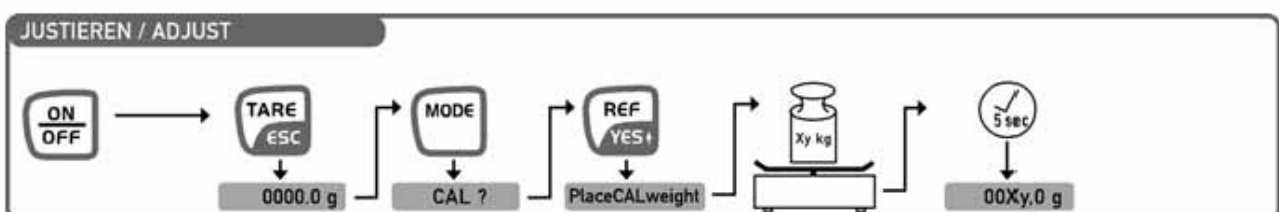



## 7 Factory Menu

The settings are only possible when not being blocked by the adjusting switch (see chapter 6.2).

### 7.1 How to Enter the Factory Menu



1. Turn ON the balance.
2. Press and hold the TARE key approx. 10 seconds until [**Factory Reset?**] appears.
3. Press MODE key once.
4. The display appears [**Contrast xx**]. The balance is now in service mode.
5. Step trough with MODE key, to return to weighing mode press TARE key once.

### 7.2 Display Contrast

1. Turn ON the balance.
2. Press and hold the TARE key approx. 10 seconds until [**Factory Reset?**] appears.
3. Press MODE key once. The display appears [**Contrast xx**].
4. With the arrow keys ,  and  insert the value and confirm with MODE key.
5. Press TARE key once to return to weighing mode.



Please notice the LCD segments are intense visible if the stored value is low. If the stored value is high the LCD segments are low visible.

### 7.3 Factory Adjustment

1. Turn ON the balance.
2. Press and hold the TARE key approx. 10 seconds until [**Factory Reset?**] appears.
3. Press MODE key twice until [**Lock ? N**] appears.
4. Set "Lock" to ON with  key. The display appears [**Lock ? Y**].
5. Press TARE key once. The balance is now in weighing mode.
6. Press MODE key once. The display appears [**Cal ? N**].
7. Press  key to start the factory adjustment. The display appears [-----], then [**Place CAL Weight**].
8. Place the **maximum weight** on the weighing pan.
9. Balance measuring for approx. one minute.
10. After that balance go back to normal weighing mode.
11. Remove the weight and **switch off the balance by pressing the ON/OFF-key**.
12. Now plug off the power supply and plug in again.







## 7.4 Automatic Linearity Adjustment

1. Turn ON the balance.
2. Press and hold the TARE key approx. 10 seconds until [**Factory Reset?**] appears.
3. Press MODE key until [**Linear auto ?**] appears.
4. Press  key to start the automatic linearity adjustment. The display appears the first linearity point, e.g. [**L1 2000.0g ?**].
5. Confirm with  key or press the MODE key to select another linearity point, which is outside the permissible tolerances, e.g. [**L2 5000.0g ?**] and confirm with  key. The display appears [**Place Lin Weight**].
6. Place the required weight on the centre of the weighing pan and wait until you will get a stable weighing result.
7. Remove the weight. Now balance is in weighing mode.
8. **Switch off the balance by pressing the ON/OFF-key.**
9. Now plug off the power supply and plug in again.

Please notice the linearity points were defined and configured in our production line. Therefore it is not possible to change them afterwards without special configuration software.

## 7.5 Manual Linearity Adjustment

1. Turn ON the balance. After warming-up time and adjustment check balance readings in all measuring points. In case of differences make a note.
2. Press and hold the TARE key approx. 10 seconds until [**Factory Reset?**] appears.
3. Press MODE key until [**Linear man ?**] appears.
4. Press  key to start the manual linearity adjustment. The display appears the first linearity point, e.g. [**L 2000.0g +00d**].
5. With the arrow keys ,  and  you can change the stored value.
6. Press the MODE key to select another linearity point, which is outside the permissible tolerances, e.g. [**L 5000.0g -07d**] and inscribe the correction value like described above in point (5.) and so on.
7. To return to normal weighing mode press TARE key once.
8. **Switch off the balance by pressing the ON/OFF-key.**
9. Now plug off the power supply and plug in again.

### Information:

If there is a positive difference (e.g. 2000.6 g = + 6 digit) you should subtract this difference to the stored value (e.g. [L 2000.0 -06d]).

If there is a negative difference (e.g. 1999.4 g = - 6 digit) you should add this difference to the stored value (e.g. [L 2000.0 +06d]).

# 8 Electronics

## 8.1 Explanation and Connection of Main PCB

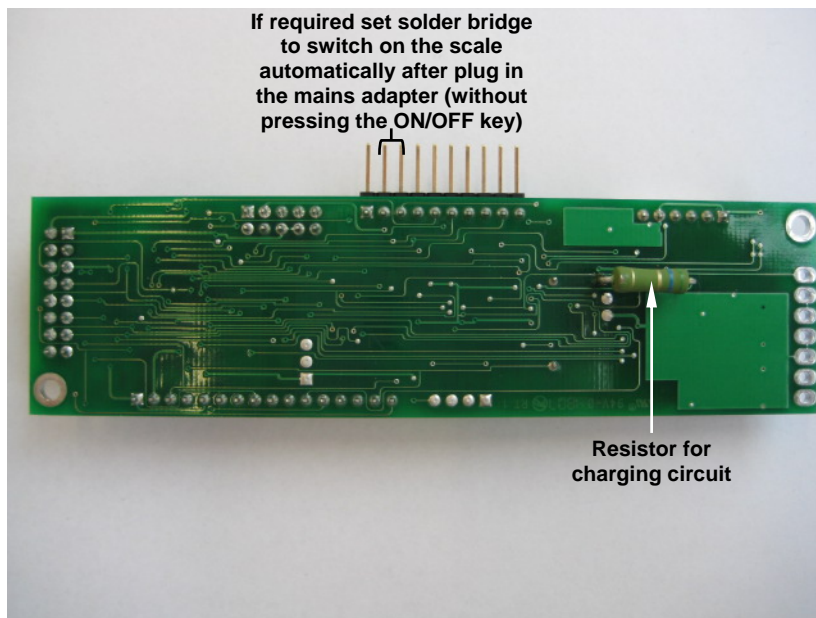
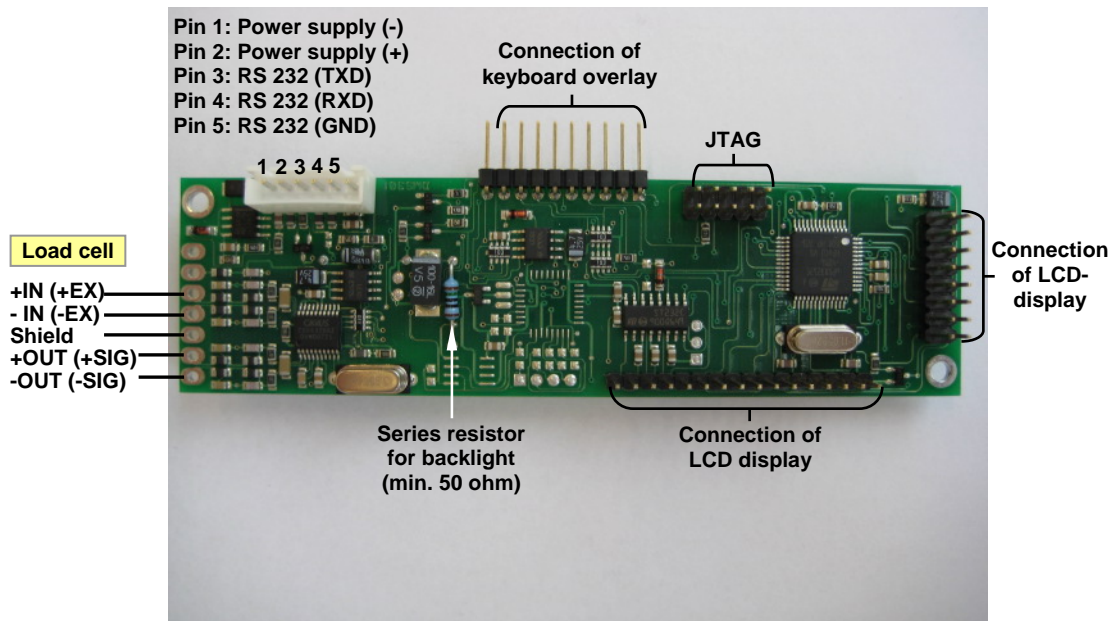

## 8.2 Layout of Main PCB

