



KERN & Sohn GmbH

Ziegelei 1

D-72336 Balingen

E-mail: info@kern-sohn.com

Tel.: +49-[0]7433- 9933-0

Fax: +49-[0]7433-9933-149

Web site: www.kern-sohn.com

Operating instructions

Precision balances

KERN PBS/PBJ

Version 1.1

09/2008

GB



PBS/PBJ-BA-e-0811



KERN PBS/PBJ

Version 1.1 09/2008

Operating instructions Precision balances

Table of Contents

1	Technical data	6
2	Declaration of conformity	10
3	Overview of devices	12
3.1	Overview of keyboard	14
3.2	View of display	16
4	Basic directions (general information)	17
4.1	Intended use	17
4.2	Inappropriate use	17
4.3	Guarantee	17
4.4	Monitoring the test substances	18
5	Basic safety directions	18
5.1	Observing the directions included in the Operating Instructions	18
5.2	Staff training	18
6	Transport and storage	18
6.1	Check upon delivery	18
6.2	Packaging	18
7	Unpacking, installation and starting	19
7.1	Place of installation, place of use	19
7.2	Unpacking	19
7.2.1	List of items delivered	19
7.2.2	Positioning	20
7.3	Mains socket	21
7.4	Connection of peripheral devices	21
7.5	First start-up	22
7.5.1	Switching on power supply	22
8	Adjustment	23
8.1	Internal adjusting (PBJ models)	23
8.2	Adjusting test with internal weight (PBJ models)	24
8.3	External adjusting (PBS models)	25
8.4	Adjusting test with external weight (PBS models)	26
8.5	Automatic adjusting with PSC function (PBJ models)	27

8.5.1	Activation of PSC function	27
8.6	Automatic adjusting with Clock-CAL function (PBJ models)	27
8.6.1	Setting Clock-CAL function:	28
8.6.2	Omitting Clock-CAL function:	28
8.6.3	Switching off Clock-CAL function:	28
9	Verification	29
10	ISO/GLP report	30
10.1	Creating printout of adjusting data report	30
10.2	Setting the balance identification number	30
11	Basic mode	31
11.1	Weighing	31
11.2	Taring	31
11.2.1	Pre-Tare (only for non verifiable PBJ models)	31
11.3	Changing the display	32
11.4	Percent determination	33
11.5	Underfloor weighing	34
11.6	Automatic reset function	35
11.7	Null region	35
12	Menu	36
12.1	Menu layout	36
12.2	Navigation in menu	36
12.3	Description of main menu	37
12.4	Setting numerical value	38
12.5	Calling up the recent menu	38
12.6	Return to standard settings (menu reset)	39
12.7	Setting decimal points	39
12.8	Menu lockout	40
13	Description of individual functions	41
13.1	Stability and reaction (average value)	41
13.1.1	Automatic mode	41
13.1.2	Filling mode	41
13.1.3	Standard mode	41
13.1.4	Antivibration mode	41
13.1.5	Antiwind mode	41
13.2	Stability detection band	42
13.3	Tracking	42
13.4	Setting date	42
13.5	Setting time	43
13.6	Setting display for stand-by mode	43
13.7	Capacity display	44
13.8	Change of minimal display (10d:1d)	44

13.9	Extreme value coverage	44
14	Application functions	45
14.1	Piece counting	45
14.2	Control weighing and target weighing	46
14.2.1	Control weighing (comparator) – display type 1	46
14.2.2	Control weighing (comparator) – display type 2	46
14.2.3	Target weighing mode	47
14.3	Density determination	48
14.3.1	Specific measurement of solid weight	48
14.3.2	Table of temperatures and densities	49
14.3.3	Specific measurement of liquid weight	50
14.4	Automatic printing function (Auto Print)	51
14.5	Taring/printing at stability (models PBJ)	52
14.6	Recipe mode	53
14.7	Automatic saving and zeroing	54
14.8	Animal weighing	55
15	Data output	56
15.1	Computer – RS-232C	56
15.1.1	Cable connection	56
15.2	Data formats	57
1.	For measuring values:	57
2.	For „oL” or „-oL”	57
15.3	Using codes of commands	58
15.4	Operator settings	63
15.4.1	Overview	63
15.4.2	Handshaking	63
15.4.3	Format	64
15.4.4	Transmission speed	64
15.4.5	Parity / bit length	64
15.4.6	Stop bits	64
15.4.7	Limiter	64
16	Service, maintenance, disposal	65
16.1	Cleaning	65
16.2	Service, maintenance	65
16.3	Disposal	65
17	Help in case of small faults	66

1 Technical data

PBJ models:

KERN	PBJ 420-3M	PBJ 620-3M
<i>Read-out (d)</i>	0.001 g	0.001 g
<i>Weighing range (max.)</i>	420 g	620 g
<i>Minimal load (min.)</i>	0.02 g	0.1 g
<i>Verification value (e)</i>	0.01 g	0.01 g
<i>Verification class</i>	II	I
<i>Reproducibility</i>	0.001 g	0.001 g
<i>Linearity</i>	± 0.002 g	± 0.002 g
<i>Signal rise time</i>	1.5 s	
<i>Calibration weight</i>	internal	
<i>Weighing units (verified devices)</i>	g, kg, ct, pcs,	
<i>Min. piece weight when counting pieces</i>	1 mg	
<i>Number of reference pieces when counting pieces</i>	5, 10, 20, 50 100, 200	
<i>Stainless steel weighing plate</i>	108 x 105 mm	
<i>Housing size (W x D x H) [mm]</i>	320 x200 x185	
<i>Dimensions of glass draft shield [mm]</i>	inside 184 x 203 x 90	
	outside 203 x 230 x 105	
<i>Net weight (kg)</i>	3.4 kg	
<i>Permissible ambient temperature</i>	from +10°C to +30°C	
<i>Air humidity</i>	max. 80%, relative (non-condensing)	
<i>Voltage</i>	Mains adaptor 220V-240V, 50 Hz Balance 12 V, 1250mA	
<i>Interface</i>	RS-232	
<i>Device for suspended weighing</i>	hook	

KERN	PBJ 4200-2M	PBJ 6200-2M	PBJ 8200-1M
<i>Read-out (d)</i>	0.01 g	0.01 g	0.1 g
<i>Weighing range (max.)</i>	4.2 kg	6.2 kg	8.2 kg
<i>Minimal load (min.)</i>	0.5 g	1 g	5 g
<i>Verification value (e)</i>	0.1 g	0.1 g	1 g
<i>Verification class</i>	II	I	II
<i>Reproducibility</i>	0.01 g	0.01 g	0.08 g
<i>Linearity</i>	± 0.02 g	± 0.02 g	± 0.1 g
<i>Signal rise time</i>	1.5 s		
<i>Calibration weight</i>	internal		
<i>Weighing units (verified devices)</i>	g, kg, ct, pcs		
<i>Min. piece weight when counting pieces</i>	5 mg		
<i>Number of reference pieces when counting pieces</i>	5, 10, 20, 50 100, 200		
<i>Stainless steel weighing plate</i>	170 x 180 mm		
<i>Housing size (W x D x H) [mm]</i>	200 x 320 x 80		
<i>Net weight (kg)</i>	4.6 kg		
<i>Permissible ambient temperature</i>	from +10°C to +30°C		
<i>Air humidity</i>	max. 80%, relative (non-condensing)		
<i>Voltage</i>	Mains adaptor 220V-240V, 50 Hz Balance 12 V, 1250mA		
<i>Interface</i>	RS-232		
<i>Device for suspended weighing</i>	hook		

PBS models:

KERN	PBS 420-3M	PBS 620-3M
<i>Read-out (d)</i>	0.001 g	0.001 g
<i>Weighing range (max.)</i>	420 g	620 g
<i>Minimal load (min.)</i>	0.02 g	0.1 g
<i>Verification value (e)</i>	0.01 g	0.01 g
<i>Verification class</i>	II	II
<i>Reproducibility</i>	0.001 g	0.001 g
<i>Linearity</i>	± 0.002 g	0.002 g
<i>Signal rise time</i>	1.5 s	
<i>Calibration weight (recommended, not added; class)</i>	400 g (E2)	600 g (E2)
<i>Possible adjustment points</i>	100 - 420 g	100 - 620 g
<i>Weighing units (verified devices)</i>	g, kg, ct, pcs	
<i>Min. piece weight when counting pieces</i>	1 mg	
<i>Number of reference pieces when counting pieces</i>	5, 10, 20, 50 100, 200	
<i>Stainless steel weighing plate</i>	108 x 105 mm	
<i>Housing size (W x D x H) [mm]</i>	320 x 200 x 185	
<i>Dimensions of glass draft shield [mm]</i>	inside 184 x 203 x 90	
	outside 203 x 230 x 105	
<i>Net weight (kg)</i>	3.4 kg	
<i>Permissible ambient temperature</i>	from +5°C to +40°C	
<i>Air humidity</i>	max. 80%, relative (non-condensing)	
<i>Voltage</i>	Mains adaptor 220V-240V, 50 Hz Balance 12 V, 1250mA	
<i>Interface</i>	RS-232	
<i>Device for suspended weighing</i>	hook	

KERN	PBS 4200-2M	PBS 6200-2M	PBS 8200-1M
<i>Read-out (d)</i>	0.01 g	0.01 g	0.1 g
<i>Weighing range (max.)</i>	4.2 kg	6.2 kg	8.2 kg
<i>Minimal load (min.)</i>	0.5 g	1 g	5 g
<i>Verification value (e)</i>	0,1 g	0,1 g	1 g
<i>Verification class</i>	II	I	II
<i>Reproducibility</i>	0.01 g	0.01 g	0.1 g
<i>Linearity</i>	± 0.02 g	± 0.02 g	± 0.2 mg
<i>Signal rise time</i>	1.5 s		
<i>Calibration weight (recommended, not added; class)</i>	4 kg	5 kg	7 kg
<i>Possible adjustment points</i>	1000 - 4200 g	1000 - 6200 g	1000 - 8200 g
<i>Weighing units (verified devices)</i>	g, kg, ct, pcs		
<i>Min. piece weight when counting pieces</i>	5 mg		
<i>Number of reference pieces when counting pieces</i>	5, 10, 20, 50 100, 200		
<i>Stainless steel weighing plate</i>	170 x 180		
<i>Housing size (W x D x H) [mm]</i>	200 x 320 x 80		
<i>Net weight (kg)</i>	2.9 kg		
<i>Permissible ambient temperature</i>	from +5°C to +40°C		
<i>Air humidity</i>	max. 80%, relative (non-condensing)		
<i>Voltage</i>	Mains adaptor 220V-240V, 50 Hz Balance 12 V, 1250mA		
<i>Interface</i>	RS-232		
<i>Device for suspended weighing</i>	hook		

2 Declaration of conformity



KERN & Sohn GmbH

D-72322 Balingen-Frommern

Postfach (PO box) 4052

E-mail: info@kern-sohn.de

Tel.: 0049-[0]7433- 9933-0

Fax: 0049-[0]7433-9933-149

Web site: www.kern-sohn.de

Declaration of conformity

EC-Konformitätserklärung
EC- Déclaration de conformité
EC-Dichiarazione di conformità
EC- Declaração de conformidade
EC-Deklaracja zgodności

EC-Declaration of Conformity
EC-Declaración de Conformidad
EC-Conformiteitverklaring
EC- Prohlášení o shode
ЕС-Заявление о соответствии

D	Konformitäts- erklärung	Wir erklären hiermit, dass das Produkt, auf das sich diese Erklärung bezieht, mit den nachstehenden Normen übereinstimmt.
GB	Declaration of conformity	We hereby declare that the product to which this declaration refers conforms with the following standards.
CZ	Prohlášení o shode	Tímto prohlašujeme, že výrobek, kterého se toto prohlášení týká, je v souladu s níže uvedenými normami.
E	Declaración de conformidad	Manifetamos en la presente que el producto al que se refiere esta declaración está de acuerdo con las normas siguientes
F	Déclaration de conformité	Nous déclarons avec cela responsabilité que le produit, auquel se rapporte la présente déclaration, est conforme aux normes citées ci-après.
I	Dichiarazione di conformità	Dichiariamo con ciò che il prodotto al quale la presente dichiarazione si riferisce è conforme alle norme di seguito citate.
NL	Conformiteit- verklaring	Wij verklaren hiermede dat het product, waarop deze verklaring betrekking heeft, met de hierna vermelde normen overeenstemt.
P	Declaração de conformidade	Declaramos por meio da presente que o produto no qual se refere esta declaração, corresponde às normas seguintes.
PL	Deklaracja zgodności	Niniejszym oświadczamy, że produkt, którego niniejsze oświadczenie dotyczy, jest zgodny z poniższymi normami.
RUS	Заявление о соответствии	Мы заявляем, что продукт, к которому относится данная декларация, соответствует перечисленным ниже нормам.

Electronic balance: KERN PBS / PBJ

Mark gained	EC Directive	Standards
CE	2004/108/EC EMC Directive	EN 55022 : 2006 (class B) EN 55024 : 1998 + A1 :2001 + A2 : 2003 EN61000-3-2 :2000+A2 : 2005 EN61000-3-3 :1995 +A1 :2001 + A2 : 2005
	2006/95/EC Low Voltage Direc- tive	EN 60950 : 2001

Date: 07.03.2008

Signature: _____

KERN & Sohn GmbH
Management

KERN & Sohn GmbH, Ziegelei 1, D-72336 Balingen, Tel. +49-[0]7433/9933-0, Fax +49-[0]7433/9933-149

Declaration of conformity

EC-Konformitätserklärung
EC- Déclaration de conformité
EC-Dichiarazione di conformità
EC- Declaração de conformidade
EC-Deklaracja zgodności

EC-Declaration of Conformity
EC-Declaración de Conformidad
EC-Conformiteitverklaring
EC- Prohlášení o shode
ЕС-Заявление о соответствии

D	Konformitäts- erklärung	Wir erklären hiermit, dass das Produkt, auf das sich diese Erklärung bezieht, mit den nachstehenden Normen übereinstimmt. Diese Erklärung gilt nur in Verbindung mit der Konformitätsbescheinigung einer benannten Stelle.
GB	Declaration of conformity	We hereby declare that the product to which this declaration refers conforms with the following standards. This declaration is only valid with the certificate of conformity by a notified body.
CZ	Prohlášení o shode	Tímto prohlašujeme, že výrobek, kterého se toto prohlášení týká, je v souladu s níže uvedenými normami. Toto prohlášení platí pouze ve spojitosti s deklarácí o souladu uvedeného pracoviště se směrnicemi EU.
E	Declaración de conformidad	Manifestamos en la presente que el producto al que se refiere esta declaración está de acuerdo con las normas siguientes. Esta declaración solo será válida acompañada del certificado de conformidad de una institución renombrada.
F	Déclaration de conformité	Nous déclarons avec cela responsabilité que le produit, auquel se rapporte la présente déclaration, est conforme aux normes citées ci-après. Cette déclaration est valide seulement avec un certificat de conformité d'un organisme notifié.
I	Dichiarazione di conformità	Dichiariamo con ciò che il prodotto al quale la presente dichiarazione si riferisce è conforme alle norme di seguito citate. Questa dichiarazione sarà valida solo se accompagnata dal certificato di conformità della parte nominale.
NL	Conformiteit- verklaring	Wij verklaren hiermede dat het product, waarop deze verklaring betrekking heeft, met de hierna vermelde normen overeenstemt. Deze verklaring geldt uitsluitend in verbinding met het certificaat van overeenstemming vanwege een daarmee belaste instantie.
P	Declaração de conformidade	Declaramos por meio da presente que o produto no qual se refere esta declaração, corresponde às normas seguintes. Esta declaração vale só em combinação com um certificado de conformidade duma instituição nomeada.
PL	Deklaracja zgodności	Niniejszym oświadczamy, że produkt, którego niniejsze oświadczenie dotyczy, jest zgodny z poniższymi normami. Niniejsze oświadczenie obowiązuje wyłącznie w połączeniu z oświadczeniem o zgodności danego miejsca.
RUS	Заявление о соответствии	Мы заявляем, что продукт, к которому относится данная декларация, соответствует перечисленным ниже нормам. Эта декларация действует совместно с удостоверением соответствия названной лаборатории.

Electronic balance: KERN PBS / PBJ

EC Directive	Standards	Number of EC type approval certificate	Issued by
90/384/EEC	EN 45501	T7356	NMI

Date: 07.03.2008

Signature:



KERN & Sohn GmbH
Management

KERN & Sohn GmbH, Ziegelei 1, D-72336 Balingen, Tel. +49-[0]7433/9933-0, Fax +49-[0]7433/9933-149

3 Overview of devices

PBJ models:

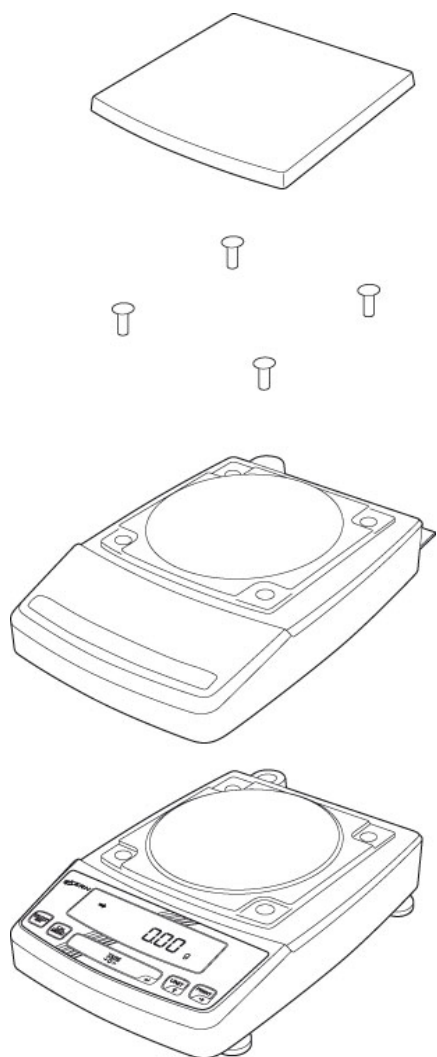

PBS models:

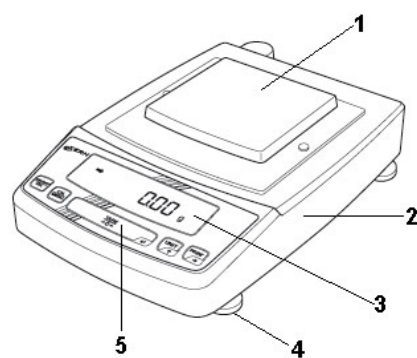
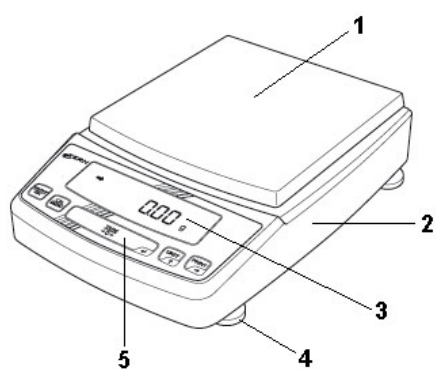
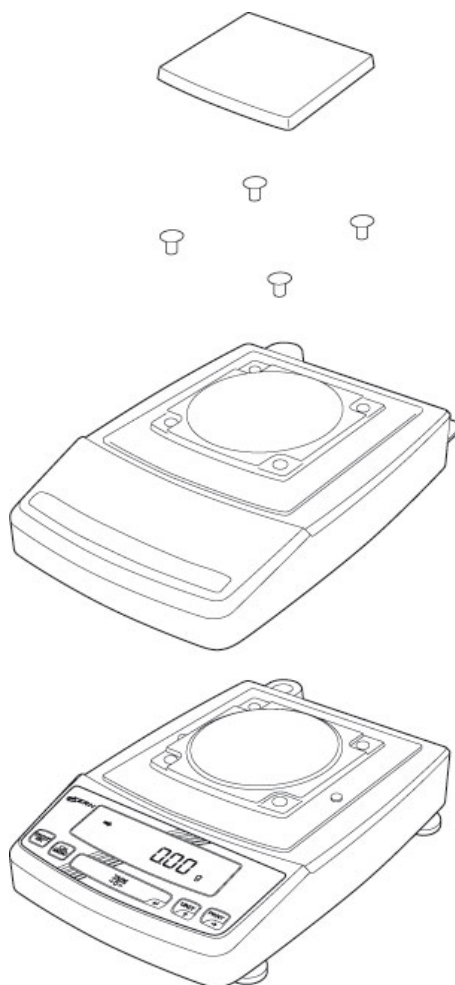

- 1 Weighing plate
- 2 Balance
- 3 Display
- 4 Levelling screws
- 5 Keys

Draft shield:

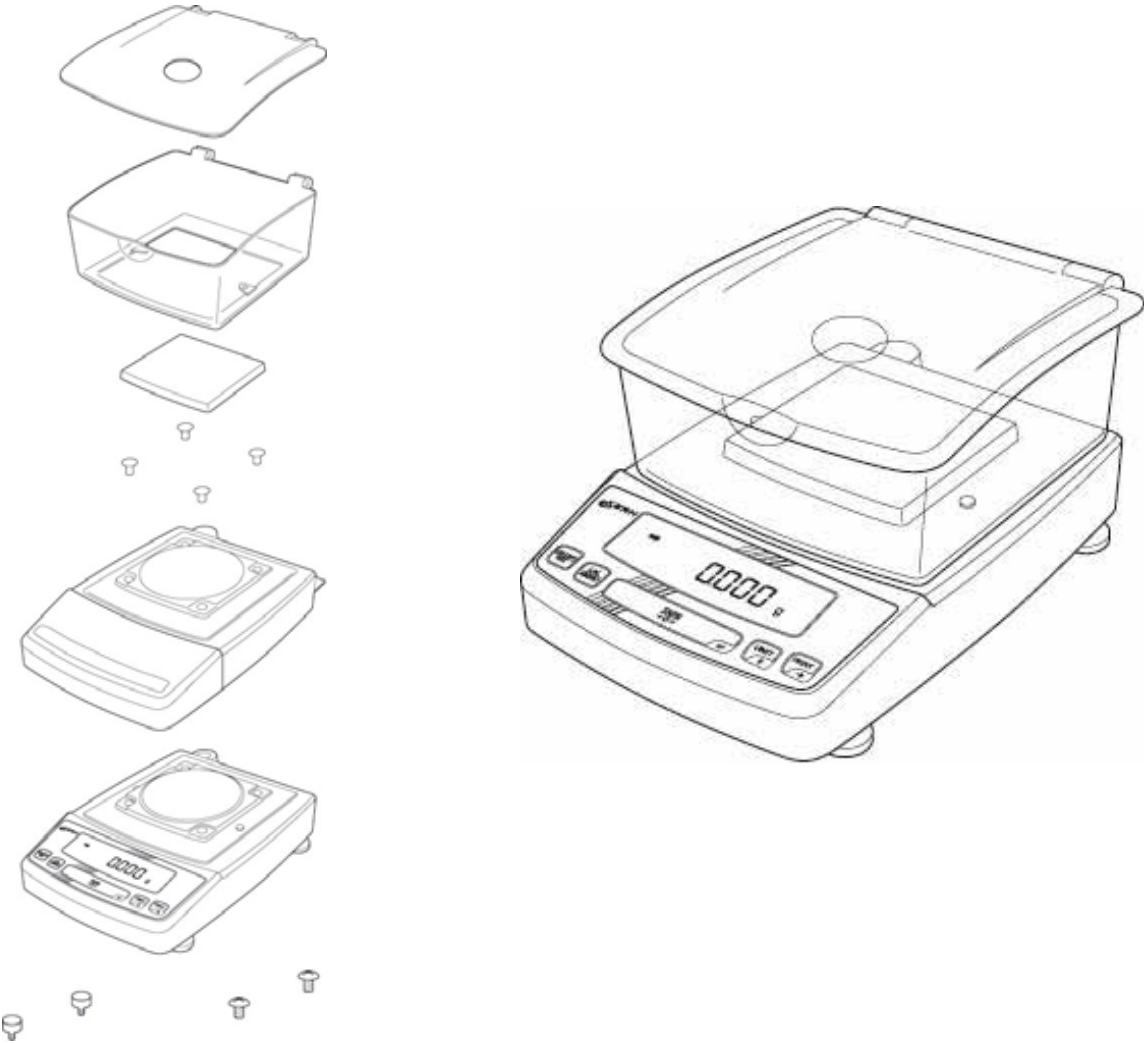



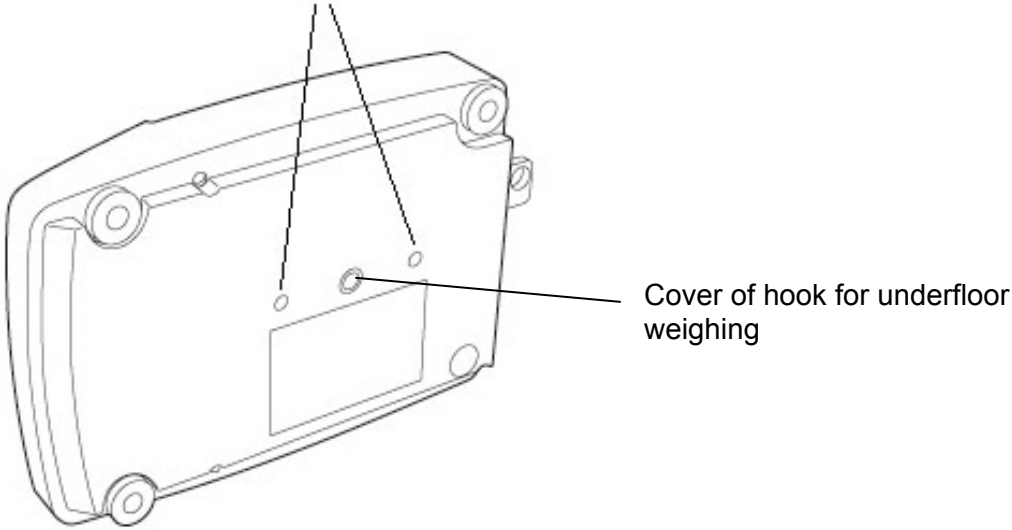

Transport screws

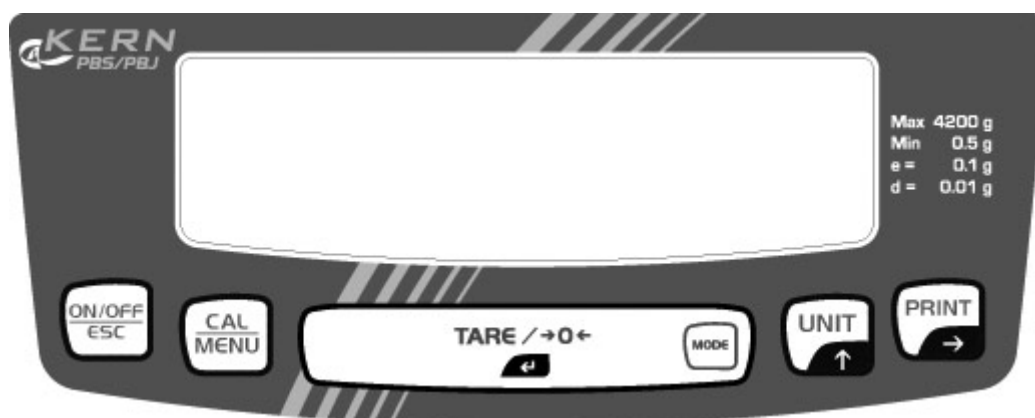

3.1 Overview of keyboard

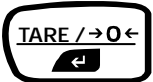

In weighing mode:

Key	Marking	Press the key once and release	Hold the key pressed for about 3 seconds
	[ON/OFF]	To switch over between operation mode and stand-by mode.	To leave the function used and return to weighing mode.
	[CAL]	To call up adjusting or the menu selection screen. (*1)	To display the menu element recently set.
	[TARE]	To tare or zero the weight display. (*2)	No function.
	[UNIT]	To change a weighing unit or select a specific weight measurement. (*3)	To switch over between 1d and 10d display. (*4) (only non verifiable PBS models)
	[PRINT]	To output a weight value to a peripheral device (printer, computer).	To output a date and time to a peripheral device.





*1 This key is used to set a value when percent (%), number of pieces (PCS), specific weight of solids (▼d) or specific weight of liquid (d) is displayed.

*2 When an initial tare value is set in the balance, the [-Pretare value] is displayed, but not zero.

*3 Units different than „g” must be first set in the balance, before they can be used for measurements. Only gram (g), percent (%) and number of pieces (PCS) are factory set.

*4 When 10d unit is set, the minimal display must be reduced by one position after the decimal point.

In menu:

Key	Marking	Press the key once and release	Hold the key pressed for about 3 seconds
	[ON/OFF]	To return to a submenu or weighing mode.	To return to weighing mode.
	[CAL]	To go to the next menu element.	To display the menu element recently set.
	[TARE]	To select or set the menu element recently displayed.	No function.
	[UNIT]	To enter numerical values. To increase numerical value of the flashing position by 1.	No function.
	[PRINT]	To enter numerical values. To go to the next position.	No function.

3.2 View of display

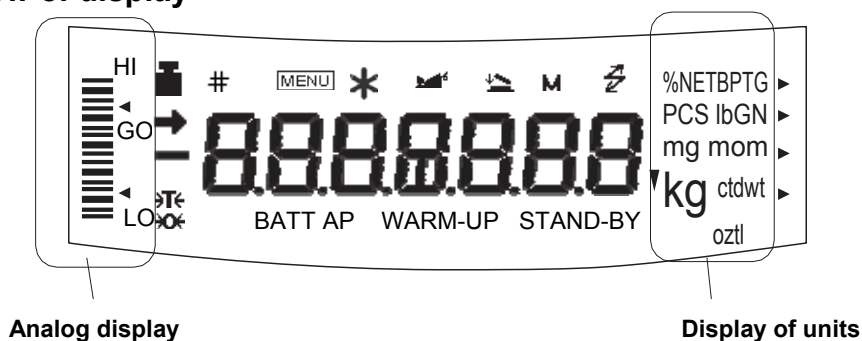

Display	Marking	Description
→	Stabilization display	It is seen when measuring value is stable. (*1) It indicates the currently selected element during menu element selection.
ST	Tare symbol	Informs about setting an initial tare value.
	Weight symbol	It is displayed during adjusting the measuring range. It indicates adjusting settings during menu selection. It flashes before starting the automatic adjusting of measuring range. Direction: If automatic adjusting of measuring range is not activated, a user must perform it when this symbol flashes. <ul style="list-style-type: none"> with built-in weight (PBJ models refer to chapter 8.5) with external weight (PBS models refer to chapter 0).
#	Numerical mark	Indicates numerical value input.
MENU	Menu symbol	It is displayed during menu selection. It is always displayed when the menu is blocked.
*	Asterisk (star)	Informs that the displayed numeric value is not the weight value.
	Communication symbol	It is displayed during communication with peripheral devices through the RS232C cable. It signals that communication functions are set to ON (switched on).
▼	Inverted triangle symbol	Indicates the setting of specific weight measurement. It is used as an alternative to the decimal point.
	Animal symbol	Indicates the setting of animal weighing function.
	Automatic storage and zeroing symbol	Indicates the setting of automatic saving and zeroing function.
AP	Automatic printing symbol	Indicates the setting of automatic printing function.
STAND-BY	Stand-by symbol	It is displayed when the balance power supply is in stand-by mode. It is also displayed when operational function changes into stand-by mode.

*1 Stabilisation symbol
When the stabilisation symbol is illuminated for a long time, the displayed value may oscillate when a weight is slowly changed or stabilisation detection range is set to high value.

4 Basic directions (general information)

4.1 Intended use

The balance you have acquired serves to determine the weighing value of the material to be weighed. It is intended to be used as a “non-automatic” balance, i.e. the material to be weighed is manually and carefully placed in the centre of the weighing plate. The weighing value can be read off after a stable weighing value has been obtained.

4.2 Inappropriate use

Do not use the balance for dynamic weighing. In the event that small quantities are removed or added to the material to be weighed, incorrect weighing results can be displayed due to the “stability compensation” in the balance! (Example: Slowly draining fluids from a container on the balance.)

Do not leave a permanent load on the weighing plate. This can damage the measuring equipment.

Be sure to avoid impact shock and overloading the balance in excess of the prescribed maximum load rating (max.), minus any possible tare weight that is already present. This could cause damage to the balance.

Never operate the balance in hazardous locations. The series design is not explosion-proof.

Structural alterations may not be made to the balance. This can lead to incorrect weighing results, faults concerning safety regulations as well as to destruction of the balance.

The balance may only be used in compliance with the described guidelines. Other areas of application/planned use must be approved by KERN in writing.

4.3 Guarantee

The guarantee shall become void in the event of the following:

- non-observation of our guidelines in the Operating Instructions,
- use outside the described applications,
- alteration to or opening of the device,
- mechanical damage or damage caused by media, liquids and usual wear and tear,
- inappropriate erection or electric installation,
- overloading of the measuring equipment.

4.4 Monitoring the test substances

The metrology features of the balance and any possible available adjusting weight must be checked at regular intervals within the scope of quality assurance. For this purpose, the responsible user must define a suitable interval as well as the nature and scope of this check. Information is available on KERN's home page (www.kern-sohn.com) with regard to the monitoring of balance test substances and the test weights required for this. Test weights and balances can be adjusted quickly and at a reasonable price at KERN's accredited DKD (Deutsche Kalibrierdienst) calibration laboratory (return to national standard).

5 Basic safety directions

5.1 Observing the directions included in the Operating Instructions

Please read these Operating Instructions carefully before erecting and commissioning the balance, even if you already have experience with KERN balances.

5.2 Staff training

The device may only be operated and maintained by trained members of staff.

6 Transport and storage

6.1 Check upon delivery

Please check the packaging immediately upon delivery and the device during unpacking for any visible signs of external damage.

6.2 Packaging

Please keep all parts of the original packaging in case it should be necessary to return items at any time.

Only the original packaging should be used for return shipments.

Before any shipment, disconnect all cables and loose/movable parts.

Install transport protection elements (if any). All parts such as weighing plate, mains adapter etc. must be protected against sliding down or damage.

7 Unpacking, installation and starting

7.1 Place of installation, place of use

The balance is designed in such a way that reliable weighing results can be achieved under normal application conditions.

By selecting the correct location for your balance, you will be able to work quickly and precisely.

Therefore, please observe the following when choosing a place of installation:

- Place the balance on a firm, level surface;
- Avoid **extreme heat as well as temperature fluctuation** caused by installing the balance next to a radiator or in the direct sunlight;
- Protect the balance against direct draughts due to open windows and doors;
- Avoid shaking during weighing;
- Protect the balance against high humidity, vapours and dust;
- Do not expose the device to extreme dampness for longer periods of time. Inadmissible bedewing (condensation of air moisture on the device) can occur if a cold device is taken into a significantly warmer environment. In this case, please keep the device for approx. 2 hours at room temperature after it has been disconnected from mains supply;
- Avoid static charging of the material to be weighed, weighing container and draft shield.

Major display deviations (incorrect weighing results) are possible if electromagnetic fields occur as well as due to static charging and instable power supply. It is necessary then to change the balance location.

7.2 Unpacking

Carefully remove the balance from its packaging, remove the plastic wrapping and position the balance in its intended working location.

7.2.1 List of items delivered

Standard accessories:

- Balance
- 4 balance plate pads
- Weighing plate
- Mains adapter
- Operating Instructions

7.2.2 Positioning

If **PBS** models are positioned, start from item 2

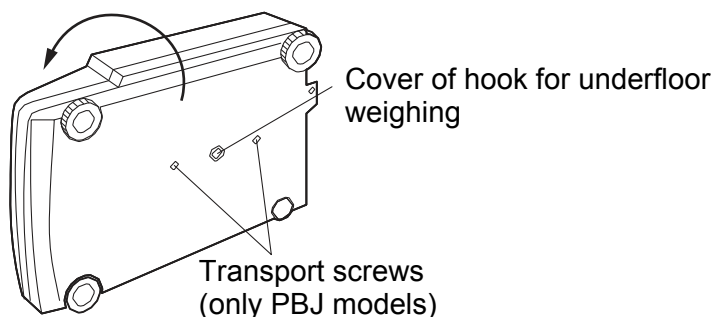

1. Turn the transport screws anticlockwise until they are locked.

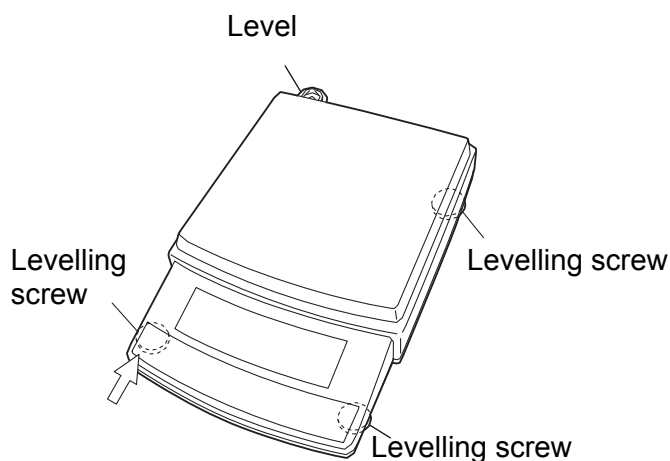

2. Balance levelling

Level the balance with the foot screws, the air bubble in the level must be located in the marked area.



- 3.** Insert four pads of the balance plate into the holes located in the balance top.
- 4.** Place the balance plate on the pads, seating the positioning elements of the balance plate precisely on the pads.
- 5.** To mount the draft shield, remove the paper from the two-sided adhesive tape.
- 6.** Mount the draft shield to the balance top.

7.3 Mains socket

Power supply is carried out by using the external mains adapter. The printed voltage value must be compliant with local voltage.

Only original KERN mains adapters should be used. The use of other products requires KERN approval.

7.4 Connection of peripheral devices

Before connection or disconnection of additional devices (printer, computer) to the data interface, the balance needs to be disconnected from mains.

The balance shall be used only together with KERN accessories and peripheral devices which are adapted to the balance in an optimal way.

Output of peripheral devices:

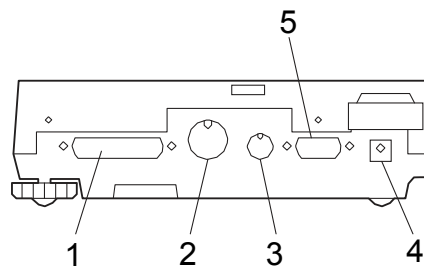

Interfaces at the balance back

- 1 RS-232C interface
- 2 DATA IO interface
- 3 AUX interface
- 4 DC-IN socket
- 5 Keyboard interface

7.5 First start-up

The warm-up time of 1 hour stabilises the measuring values after switching on.
The accuracy of the balance depends on local acceleration of gravity.
Please ensure to observe the directions included in the chapter on adjusting.

7.5.1 Switching on power supply

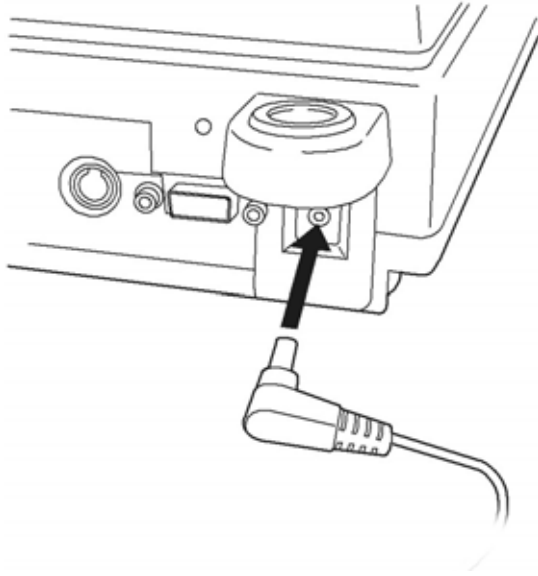



1. Connect the mains adapter plug into the DC-IN socket located at the balance back.
2. Plug the mains adapter into the mains socket.

The diagnostic balance self-check is performed and the following messages or results are displayed in the given sequence:

[HELLO], **[CHE 5]**, **[CHE 4]**, **[CHE 3]**,
[CHE 2], **[CHE 1]**, **[CHEO]**, highlighting
the whole, **[oFF]**.

[CHE 5] and **[CHE 4]** are not displayed
in the **PBS** models.

3. Press the  key.
The whole display shall go out and be
switched over to gram symbol display.
The background highlight shall be
activated.

4. The weight symbol  flashes before
starting the automatic adjusting of measur-
ing range. (refer to chapter 3.2).

8 Adjustment

As the acceleration value due to gravity is not the same at every location on earth, each balance must be coordinated - in compliance with the underlying physical weighing principle - to the existing acceleration due to gravity at its place of location (only if the balance has not already been adjusted to the location in the factory). This adjustment process must be carried out during the initial start-up, after change in location and variation of surrounding temperature. It is also recommended to adjust the balance periodically during weighing operation in order to obtain exact measured values.

Observe stable environmental conditions. A warm-up time of 1 hour is necessary for stabilisation. Pay attention that there are not any objects on the balance plate.

Note:

Before shipment, devices are set in the following way:

- **PBJ** models: Adjusting with internal weight
- **PBS** models: Adjusting with external weight

8.1 Internal adjusting (PBJ models)

Precondition: „iCAL” setting

Make sure that the gram symbol is displayed on the balance and scale pan is empty.



Press the  key. The display will show „i-CAL” symbol.

(If the „i-CAL” symbol is not displayed, return to the gram symbol display and select the menu element **1** according to the menu overview.)



Press the  key. The display will show the „i-CAL 3” symbol.

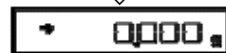
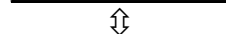
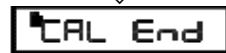
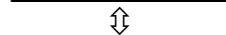
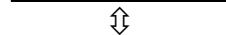
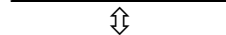
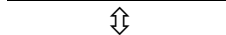

After displaying „i-CAL 2”, „i-CAL 1”, „SET”, „CAL End” in turn, the gram symbol will be displayed.

Calibration is finished.

8.2 Adjusting test with internal weight (PBJ models)

Note:

It does not refer to the supervised balances which are used as measuring devices compliant with the law within EU.

Precondition: „i-tEst” setting

Make sure that the gram symbol is displayed on the balance and scale pan is empty.

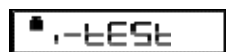

Press the  key. The display will show the „i-tEst” symbol.

(If the „i-tEst” symbol is not displayed, return to the gram symbol display and select menu element **2** according to the menu overview.)



Press the  key.



The display shows successively symbols from „i-tEst2” to „d xxx”. (xxx indicates numeric value).

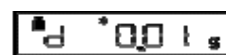

The „d” value informs about difference between the present calibration weight value and calibration weight value of the recent adjusting.

To enable carrying out the adjusting test, the „d” value needs to be



reset with the  key.

The „SEt” symbol will be shown on the display for a while.

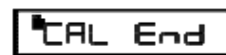

When the adjusting test is finished, the „CALEnd” symbol will be displayed.

Note:

Reset of the „d” value starts simultaneous performance of adjusting.

8.3 External adjusting (PBS models)

Adjusting function blocked for verified balances (exception verification class I). To unblock adjusting function flip unlock switch (exception verification class I)

Precondition: „E-CAL” setting

Make sure that the gram symbol is displayed on the balance and scale pan is empty.



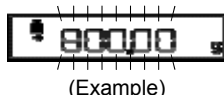

Press the  key. The display will show the „E-CAL” symbol.

(If the „E-CAL” symbol is not displayed, return to the gram symbol display and select the menu element **3** according to the menu overview.)

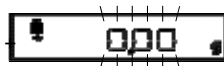

Press the  key. The display will show the flashing value of calibration weight which is to be used.*



Place the given calibration weight and press the  key. The zero display will flash for a moment.





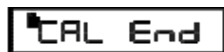

Remove the weight and press the  key.



The display will show the „SEt” symbol for a while.

When the adjusting is finished, the „CALEnd” symbol will be displayed.

* Change of the used calibration weight:

With the  key it is possible to introduce changes of the calibration weight value. Pressing the  and  key will change value, and pressing the  key will finish introduction. To stop introduction of changes, press the **[ON/OFF]** key.

8.4 Adjusting test with external weight (PBS models)

Note:

It does not refer to the supervised balances with internal calibration weight which are used as measuring devices compliant with the law within EU.

Precondition: „E-tEst” factory setting

Make sure that the gram symbol is displayed on the balance and scale pan is empty.



Press the  key. The display will show the „E-tEst” symbol.

(If the „E-tEst” symbol is not displayed, return to the gram symbol display and select menu element 4 according to the menu overview.)



(Przykład)

Press the  key. The display will show the flashing value of calibration weight which is to be used.*

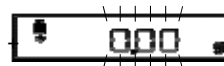

Place the given calibration weight and press the  key.

The zero display will flash.

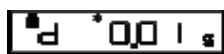

Remove the weight and press the  key.

The display shows „d xxx” symbol. (xxx indicates numeric value).

To enable carrying out the adjusting test, the „d” value needs to be

reset with the  key.







The display will show the „SEt” symbol for a while.



When the adjusting is finished, the „CALEnd” symbol will be displayed.

* Change of the used calibration weight:

With the  key it is possible to introduce changes of the calibration weight value. Pressing the  and  key will change value, and pressing the  key will finish introduction. To stop introduction of changes, press the  key.

Note:

Reset of the „d” value starts simultaneous performance of adjusting.

8.5 Automatic adjusting with PSC function (PBJ models)

If PSC function is activated, then adjusting is carried out automatically by using the internal calibration weight when the balance detects temperature change which can have negative influence on weighing accuracy.

8.5.1 Activation of PSC function





PSC function is activated according to the menu overview by using the menu element **5**.



PSC function is deactivated according to the menu overview by using the menu element **6**.

Note:

- The flashing weight symbol  signals that automatic adjusting is approaching.
- When PSC function is started during the balance use, press and hold the  key pressed to interrupt this process.

Note:

If PSC function is not activated, then a user must carry out adjusting with the internal calibration weight (chapter 8.1) when the weight symbol  is flashing.

8.6 Automatic adjusting with Clock-CAL function (PBJ models)

The balance can be equipped in such a way that with the help of the internal calibration weight and built-in automatic clock, adjusting will be performed at specified times (up to three times a day „ACALt1”, „ACALt2” i „ACALt3”). The Clock-CAL function is especially useful when reports from regularly performed adjusting are required or adjusting should be performed during pauses to avoid interruptions in measuring operations.

The weight symbol flashes for about two minutes as an indication of the approaching adjusting.

- When the Clock-CAL function is started during the balance use, press the  key to interrupt this process.
- The function is switched off if all three times are set to „00:00”.

8.6.1 Setting Clock-CAL function:

Example for „ACALt1” at 12 o'clock at noon:
Select the menu element 7 in the menu overview.

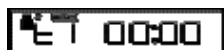

Set the required time

(refer to numerical entry, chapter **Fehler! Verweisquelle konnte nicht gefunden werden.**).

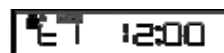



Confirm by pressing the  key.

The set time will be saved.



The „SET” symbol will illuminate for a while.



With the  key, go to setting the next time or return to weighing mode by pressing the  key.

8.6.2 Omitting Clock-CAL function:

When the Clock-CAL function is started during the balance use, press the  key and the process will be interrupted.

8.6.3 Switching off Clock-CAL function:

The function is switched off if all three times („ACALt1”, „ACALt2”, „ACALt3”) are set to „00:00”.

9 Verification

General information:

According to the EU Directive 90/384/EEC, balances must be verified officially if they are to be used as follows (legally regulated area):

- a) For commercial transactions if the price of goods is determined by weighing,
- b) For production of medicines in pharmacies as well as for analyses in the medical and pharmaceutical laboratories,
- c) For official purposes,
- d) For production of finished packages.

In case of doubt, please contact your local Office of Weights and Measures.

Verification information

An EU qualification approval is available for those balances marked as appropriate for verification in the technical data. In the event that the balance is applied in an area subject to verification as described above, it must be officially verified and re-verified at regular intervals.

Re-verification of a balance is carried out in compliance with the respective legal provisions of the particular country. The term of verification validity for balances in Germany, for example, is normally 2 years.

The legal provisions of the country of use are to be observed!

After verification, the balance shall be sealed at the indicated positions.

Verification of the balance without „the seal” is invalid.

Position of „seals”:

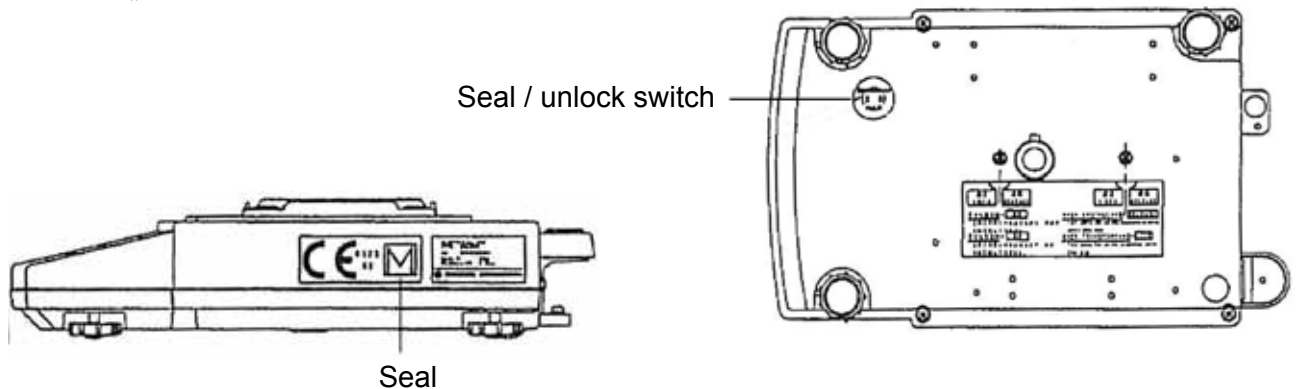

Balances which are subject to verification must be taken out of operation if:

- the **weighing result** from the balance is outside the **operational error limit**. Therefore at regular intervals, load the balance with known test weights (approx. 1/3 of the maximum load) and compare the display value with the test weight.
- **the re-verification date has been exceeded.**

10 ISO/GLP report

The quality assurance systems impose requirements for printing weighing results and correct adjusting of the balance together with date, time and the balance identification number. The easiest way to get them is by using the connected printer.

10.1 Creating printout of adjusting data report

This function ensures automatic report printing after each adjusting. With an optional printer it is possible to print those reports according to GLP, GMP or ISO9000 standard.

Creating the report printout:

- menu overview - menu element **68**

Switching off the function of report printing:

- menu overview - menu element **69**

10.2 Setting the balance identification number

Individual balances can be identified according to the serial number.

To add the four position identification number to the report printout, select the menu element **70** in the menu overview and enter 4-position number from „0000” to „9999”.

11 Basic mode

11.1 Weighing

Direction: A warm-up time of 1 hour is necessary for stabilisation.

- ⇒ Switch on the balance with the  key. The balance self check is performed. The balance is ready for weighing when the weigh display of „0.00 g” is displayed.

Direction: The  key makes it possible to zero the balance if necessary and at any moment.

- ⇒ Put a material to be weighed. Wait till the stabilisation display (➔) appears, and then read the weighing result.

11.2 Taring

The dead weight of any weighing container may be tared away by pressing the key, so that the following weighing shows the net weight of material to be weighed.

- ⇒ Put the empty tare container on the weighing plate. When the stabilisation display „➔” appears, total weight of the put container is displayed.
- ⇒ Press the  key to start taring. The display is set to „0.00”.
- ⇒ Put material to be weighed into the tare container.
- ⇒ When the stabilization display appears, read the material weight on the display.

Note:

When the balance is unloaded, the saved tare value is displayed with „negative” sign. To delete the saved tare value, remove all items from the weighing plate and then

press the  key.

The taring process can be repeated any number of times. The limit is reached when the whole weighing range is exhausted.

11.2.1 Pre-Tare (only for non verifiable PBJ models)

This function allows for the weighing of a sample located in a box/container without the necessity to open this box/container.

Choose menu item 36 from the menu overview and enter the pre-tare value.





11.3 Changing the display

By repeated pressing the  key it is possible to change the display between the active units.







The factory setting provides the following options:

[g] → [%] → [PCS]

Other settings can be activated in the menu in the following way:

 (Example)	<p>Menu overview - element numbers from 54 to 62:</p> <p>To switch over between units, press the  key.</p> <p>Save the selected unit by pressing the  key.</p>
	<p>The „SET” symbol will illuminate for a while.</p> <p>The unit has been accepted.</p>

11.4 Percent determination

	<p>In weighing mode, press the  key repeatedly until the „%” symbol will be seen on the display.</p>
<p>Setting 100% of the reference value:</p>	
	<p>Press the  key to tare the balance.</p>
	<p>Put the reference sample which represents 100% value. This value must correspond to 100 or more counts in „g” unit.</p>
	<p>When the stabilisation display → appears, press the  key at once.</p>
	<p>The „SET” symbol will illuminate for a while.</p>
	<p>The reference sample weight will be shown as 100%.</p>
	<p>Weights of next samples will be displayed as a percent value of the reference sample weight.</p>

11.5 Underfloor weighing

Objects which, because of their size or shape, cannot be put on the pan, can be weighed by means of underfloor weighing.

Proceed as follows:

- Switch off the balance.
- Open the cover plate on the base of the balance.
- Place the balance over an opening.
- Suspend the item to be weighed on the hook and carry out weighing.

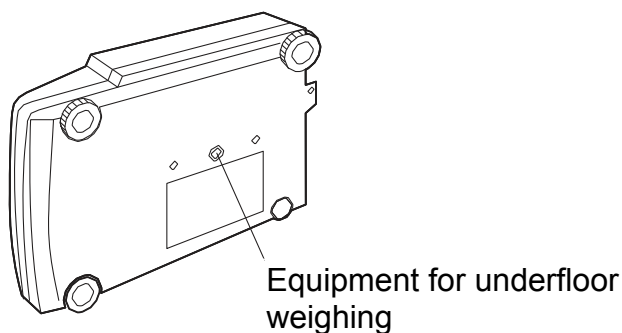

CAUTION

- Always ensure that all suspended objects are stable enough to hold the desired goods to be weighed safely (risk of breaking).
- Never suspend weights that exceed the stated maximum load (max) (risk of breaking).

Always ensure that there are no persons, animals or objects under the load that might be injured or damaged.



DIRECTION

After completing the underfloor weighing, the opening in the floor of the balance must be closed again (dust protection).

11.6 Automatic reset function

(only possible with non verifiable setting)

When the value display stays within the null region and the stability indication is lit the reset function will be carried out automatically. The null icon appears.

To activate the reset function choose menu item **41**.

11.7 Null region

To check whether a sample was placed on the scale pan use the null region as reference value.

To determine the null region choose menu item **48**.

12 Menu

The balance operating menu makes it possible to adapt the balance behaviour way to individual requirements. The balance operating menu is set in factory in such a way that no changes are required in most of rules. In the case of special application conditions, the balance can be set according to individual requirements with the operating menu.

12.1 Menu layout





The menu consists of **7 groups** and **4 levels**.

This structure is explained in the menu overview, and the access to the required functions is facilitated by using numbers for the appropriate menu elements. To move within the menu area, use the menu overview.

12.2 Navigation in menu

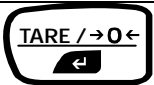
Each menu element in the menu overview is indicated with a number.

Use keys to move within the menu area:

Key	Direction in menu	Description
	↓	Selecting the menu and scrolling items of menu groups or scrolling from top to bottom.
	→	Selection of the present element or changing to the next one.
	↑	Return to a menu level.
	←	Hold the key pressed to return to the weighing mode.
		Entering a numerical value. Increasing a numerical value of the flashing position by 1.
	→	Entering a numerical value. Moving to the next position.

Note:

The  symbol is displayed when menu elements are selected.

12.3 Description of main menu



Menu group	Symbol which flashes at the front of menu	Menu elements included
1		Adjusting
2	Analogue display	Analogue display, control weighing, taring
3	E	Installation environment and taring
4	A	Operational measurements and autonomous output
5	U	Conversion of units and specific weight measurement
6	S	Setting the clock and creation of adjusting data block
7		Communication with a computer and peripheral devices

12.4 Setting numerical value

Numerical values are entered with the balance keys.

When a value is entered, both the  symbol and # symbol illuminate and the entry position flashes.



Press the  key to increase value of the flashing position by 1.



Press the  key to move the flashing place one position **to the right**.



Press the  key to save the displayed value.



The „SET” symbol indicates that the value saving has been completed successfully.

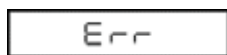

The „Err” symbol indicates that the value saving has not been possible.

Press the  key to finish entry of the numerical value.



The „Abort” message is displayed on the balance for a while, and then moving to the menu located one level higher occurs.

12.5 Calling up the recent menu

This function is useful when the use requires frequent changes of the particular menu element.

In weighing mode or during menu selection, press and hold the  key pressed for about 3 seconds. As a result of that the menu element, which has been recently changed or set, will be displayed.

12.6 Return to standard settings (menu reset)



The procedure described below explains how to reset the menu and return to the standard settings.

The standard settings in the description of the menu layout are indicated with the * symbol.



To reset the menu, select the menu element **72**.



Make sure that the balance is in the weighing mode. („g” unit is displayed)

 Press the  key 8 times,
the letter „S” of the SELEAUS symbol is flashing.

 Press the  key,
the menu group 6 is selected.





 Press the  key repeatedly
until the letter „r” in the „S-dtSCr” symbol starts flashing.

 Press the  key
until the „rESEt?” symbol is displayed („?” symbol without a dot).

 Press the  key once again,
the „rESEt” symbol indicates that the menu reset has been finished.

Press and hold the  key pressed to return to the weighing mode.

12.7 Setting decimal points

- Press the  key repeatedly until the last position starts flashing. Press the  key once again to call up the decimal point setting mode. The inverted triangle symbol ▼ or present decimal point is flashing.
- Press the  key to move the decimal point each time one position towards the required position.
- Press the  key to set the decimal point position. The „SEt” message displayed for a while indicates that the setting has been finished.

12.8 Menu lockout

The „menu lockout function” makes it possible to lock menu selections to prevent undesirable changes.

This function can be activated when „oFF” is displayed.

oFF

When the „oFF” symbol is displayed, press and hold the  key pressed.

LoCKEd

The „LoCKEd” symbol will be displayed to inform that the menu is locked.

oFF

Switching off menu lockout:

Switch off the balance mains supply and switch it on again after 10 minutes.

oFF

When the „oFF” symbol is displayed, press and hold the  key pressed.

rELEASE

The „rELEASE” symbol will be displayed to inform that the menu lockout has been switched off.

oFF

13 Description of individual functions

13.1 Stability and reaction (average value)

It is possible to adapt a display value stability and the balance reaction degree to requirements of the particular application or installation environment. There is a possibility of selection among five operating modes. Please note that in general slowing down reaction times result in higher stability of the set data handling, while speeding up reaction times have an influence on the stability deterioration. However, the balances of PBS/PBJ type are designed to ensure both properties i.e. fast reaction time and high stability.

13.1.1 Automatic mode

Select the menu element **22**:

The balance automatically and dynamically undertakes to optimally determine the average value during observation of load data. If there are not any special circumstances, this setting should always be used.

13.1.2 Filling mode

Select the menu element **23**:

This mode is suitable for weighing invariable liquid volumes. It is very susceptible to wind and vibration.

(When the filling mode is active, the  key makes it possible to switch over between 3 stability settings.)

13.1.3 Standard mode

Select the menu element **24**:

This mode is suitable for weighing in normal environment. Determination of the average value is fixed and is not subject to adaptation as in the automatic mode which is performed dynamically.

13.1.4 Antivibration mode

Select the menu element **25**:

This mode should be used if the balance is placed at a location where there are strong vibrations, and its readings fluctuate in automatic mode. The balance reaction is deteriorated in a result of small changes of weight.

13.1.5 Antiwind mode

Select the menu element **26**:

This mode should be used if the balance is placed at a location where it is exposed to air currents which cause fluctuations of its readings in automatic mode.

This reaction is deteriorated even more than in the antivibration mode, but the weighing process is more stable.

13.2 Stability detection band

(up to 8 counts for verifiable, up to 64 counts for non verifiable models)

The band makes it possible to select conditions at which the balance should be considered as stable. If „1 count” is selected, and the reading (within counting the readings) remains constant, the balance is considered as stable and the → stability display is shown. The stability detection band can be set from 2 to 64 counts.

Select the menu element:

27	for	1 count
28	for	2 counts
29	for	4 counts
30	for	8 counts



13.3 Tracking

Tracking is the function which ensures to receive present value displaying in possible long period.

To ACTIVATE this function, select the menu element **34**.

To DEACTIVATE this function, select the menu element **35**.

13.4 Setting date

With the menu element **63**, the  key and  key it is possible to set two last positions of a year, month and day.



Example:

 the date of 29th February 2004 is set as „04.02.29”.

Note:

- The built-in clock automatically makes corrections for a leap year.
- When the  key is pressed to complete setting the date, the reset of seconds is performed. If date is set after time, value of seconds is incorrect. Therefore, it is important to set the date at first and then time or correct value of seconds with the second correction function (\pm) in the way described in chapter 13.6.

13.5 Setting time

With the menu element 64, the  key and  key it is possible to set time in the 24-hour system.

Example:

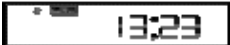
 The time of 1:23 PM is set as „13:23”.

Note:

When the  key is pressed, seconds are reset to 00.

13.6 Setting display for stand-by mode

Determine what is to be displayed in the stand-by mode.

- If **time** is to be displayed in the stand-by mode, select the menu element **65**.
- If **date** is to be displayed in the stand-by mode, select the menu element **66**.
- If **neither time nor date** is to be displayed in the stand-by mode, select the menu element **67**.

Note:

If time is displayed in the stand-by mode, the following functions are at disposal:

- **Displaying seconds:**

With the  key it is possible to activate/deactivate displaying seconds.

- **Correction by ± 30 seconds:**

When seconds are displayed, press the  key. If the value is within 00 - 29 seconds, the seconds will be rounded off to zero. If the value is within 30 - 59 seconds, the seconds will be rounded off to one minute and displayed as 00 seconds.

13.7 Capacity display

This function makes it possible to present the load placed on the balance plate in the form of the bar graph display. It is used to avoid „oL” (overload) states suddenly occurring during the measuring process.

Select the menu element **11** in the menu overview to set the full range mode:

(1)



The bar located within the lower scale range indicates that the weight located on the scale pan is small. (1)

(2)



The bar approaching the upper scale range indicates that the weight located on the scale pan almost reaches the balance capacity. (2)

If the bar graph is not to be displayed, press the menu element **21**

13.8 Change of minimal display (10d:1d)

(only possible with non verifiable PBS models)

If necessary, it is possible to decrease resolution of minimal display by one decimal place.

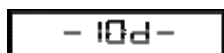

Hold the  key pressed for about 3 seconds. The display will show „- 10d -” symbol, and this display value will be reduced by one position.

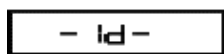

Hold the  key pressed for about 3 seconds. The display will show „- 10d -” symbol, and the display value will return to the previous number of places after the decimal point.

Note:

Position of the decimal point on the display does not move. The last position of „10d” display is empty.

13.9 Extreme value coverage

(only possible with non verifiable setting)

The “extreme value” stands for the highest or lowest value indicated after a value alteration of more than fivefold the null region.

To determine the extreme value, choose menu item **49**.

14 Application functions

14.1 Piece counting

With piece counting you can either count pieces into a container or remove pieces from a container. To enable counting a greater number of pieces the average weight per piece has to be determined with a small quantity of pieces (reference quantity). The larger the reference quantity, the higher the counting exactness. The reference quantity must be selected especially high for small pieces or pieces with considerably different sizes.

The process is carried out in four steps:

- Tare the weighing container,
- Determine reference quantity,
- Weigh reference quantity,
- Count the pieces.

Precondition: Activate the PCS function with the menu element **57** if it is not set. (The unit of PCS function is factory set.)

Make sure that the balance is in the weighing mode. (the unit of „g” is displayed)

Press the  key repeatedly until the „PCS” symbol is displayed.



Place the container on the balance plate and tare the balance with the  key.

Count exactly 9 (or 10, 20, 50, 100 or 200) pieces of the sample to be weighed and put them into the container.

Press the  key.

(Example)



Pressing the  key switches over display among the following symbols „Ld 5pcs” ... „Ld 200pcs”, „Ld 5pcs” ...

The standard setting is „Ld 10pcs”.



Press the  key when the display corresponds to the number of the pieces being put.



The reference quantity is saved.

14.2 Control weighing and target weighing

14.2.1 Control weighing (comparator) – display type 1

It is the most suitable method which makes it possible to assess weighing courses or errors on the basis of the sample weight.

Select the menu element **15** in the menu overview.

Display elements used

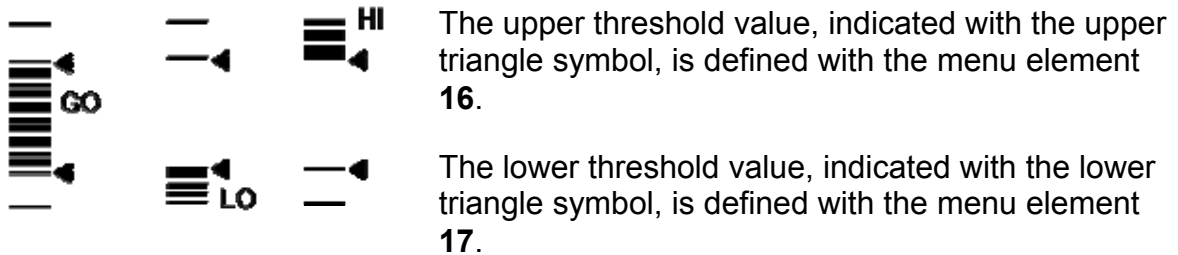

Note:

Determination is carried out in the following way:

Upper threshold value	< sample weight	HI
Lower threshold value	\leq sample weight \leq upper threshold value	GO
Sample weight	< lower threshold value	LO

14.2.2 Control weighing (comparator) – display type 2

This mode should be used for classifying on the basis of the sample weight. The display looks like a bar graph, but it also includes the control weighing function.

Select the menu element **18** in the menu overview.

Display elements used

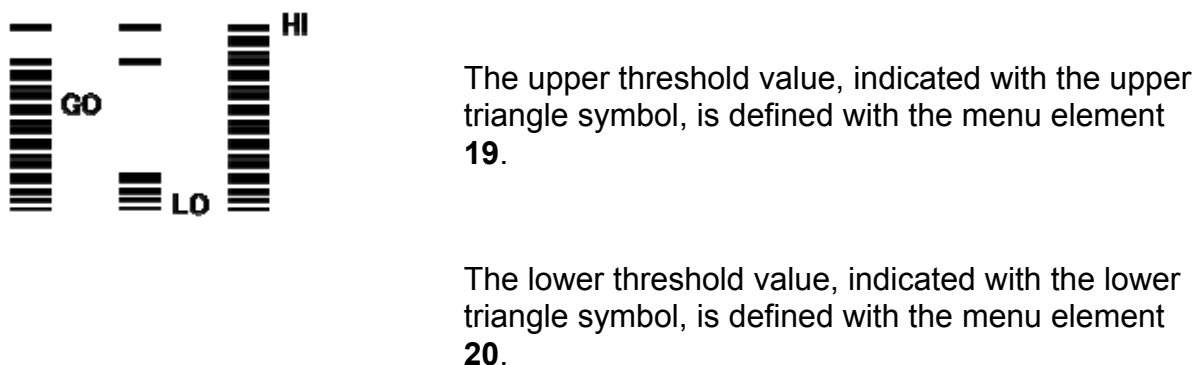

Note:

Determination is carried out in the following way:

Upper threshold value	< sample weight	HI
Lower threshold value	\leq sample weight \leq upper threshold value	GO
Sample weight	< lower threshold value	LO

14.2.3 Target weighing mode

This mode is used to weigh constant quantities of liquids and to assess missing and excessive quantities.

The target value is a numerical value which corresponds to quantity of the set unit to be used for weighing. The limit value is a numerical value which lies above and below the accepted target value. The target value on the analogue display is presented as the centre line. The limit values are indicated with the triangle symbols. The movable bar presents the current weight on the scale pan.

The target weighing mode is selected with the menu element **12**.

Display elements used

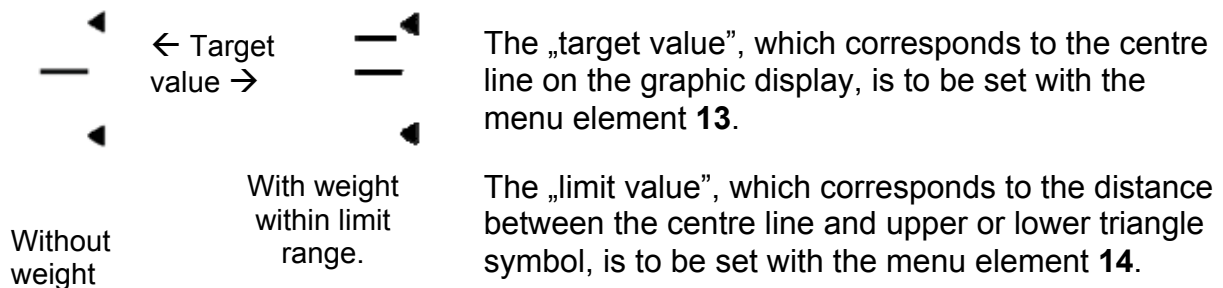





14.3 Density determination

14.3.1 Specific measurement of solid weight

In the case of specific measurement of solid weights, the sample (solid) weight is measured in air as well as in the liquid with known density and the sample density is calculated on the basis of that results. The ▼ symbol presents the solid density on this balance. The way of density determination with the underfloor weighing equipment is described below.

Carrying out the density determination with the optional density determination set is simpler. More information on this can be found in the operating instructions which are attached to the density determination set.

Select the menu element **60** in the menu overview.

- From the below table (chapter 14.3.2) enter the density value (g/cm^3) of the liquid (water, alcohol etc.) in which the sample is immersed. (Entering numerical values, refer to chapter 11.4, setting decimal point, refer to chapter 11.7). To write off the setting, zero the value.
- Remove the cover of the hook for underfloor weighing in the balance bottom.
- Attach the scale pan to be hung on the hook and immerse it in the container filled with the liquid with known density.
- Restore the weighing mode with the  key and repeatedly press the  key until the „▼d” (inverted triangle and „d”) symbol is displayed.
- Confirm with the  key.
- Place the sample on the balance plate. (If necessary, the „dSP oL” symbol will be displayed, which does not indicate any disturbance.)
- When the → stabilisation display is illuminated, press  key.
- Place the sample on the scale pan to be hung. The sample density will be displayed.

Note:

- 4 positions after the point is displayed for the specific weight. If it is not possible to stabilize the balance with all four positions after the point, use the 1d/10d switch over function (refer to chapter 12.8).
- If the sample lies on the scale pan immersed in the liquid, make sure that the whole sample is immersed in the liquid.
- The balance is not zeroed again if the  key is pressed within this function.

14.3.2 Table of temperatures and densities

temperature [°C]	Density ρ [g/cm ³]		
	Water	Ethyl alcohol	Methyl alcohol
10	0.9997	0.7978	0.8009
11	0.9996	0.7969	0.8000
12	0.9995	0.7961	0.7991
13	0.9994	0.7953	0.7982
14	0.9993	0.7944	0.7972
15	0.9991	0.7935	0.7963
16	0.9990	0.7927	0.7954
17	0.9988	0,7918	0.7945
18	0,9986	0.7909	0.7935
19	0,9984	0.7901	0.7926
20	0.9982	0.7893	0.7917
21	0.9980	0,7884	0.7907
22	0.9978	0,7876	0.7898
23	0.9976	0,7867	0.7880
24	0.9973	0,7859	0.7870
25	0.9971	0.7851	0.7870
26	0.9968	0.7842	0.7861
27	0.9965	0.7833	0.7852
28	0.9963	0.7824	0.7842
29	0.9960	0.7816	0.7833
30	0.9957	0.7808	0.7824
31	0.9954	0.7800	0.7814
32	0.9951	0.7791	0.7805
33	0.9947	0.7783	0.7896
34	0.9944	0.7774	0.7886
35	0.9941	0.7766	0.7877



14.3.3 Specific measurement of liquid weight

In the case of specific measurement of liquid weight, the weight of reference solid with known volume is measured in air and the liquid to be tested. The specific liquid weight is calculated on the basis of those both values.

The display unit for the specific liquid weight is „d”.

Carrying out the density determination with the optional density determination set is simpler. More information on this can be found in the operating instructions which are attached to the density determination set.

Select the menu element **61** in the menu overview.

- Enter the displacer density value.
- Remove the cover of the hook for underfloor weighing in the balance bottom.
- Attach the displacer on the hook and immerse it in the container filled with the liquid to be tested.
- Restore the weighing mode with the  key and repeatedly press the  key until the „d” symbol is displayed.
- Place the displacer on the balance plate.
- When the → stabilisation display is illuminated, press the  key. (If necessary, the „dSP oL” symbol will be displayed, which does not indicate any disturbance.)
- Place the reference weight on the scale pan and immerse it in the tested liquid. The specific weight of the tested liquid will be displayed.

Note:

- 4 positions after the point is displayed for the specific weight. If it is not possible to stabilize the balance with all four positions after the point, use the 1d/10d switch over function (refer to chapter 0).
- If the reference weight lies on the scale pan immersed in the liquid, make sure that the whole weight is immersed in the liquid.

14.4 Automatic printing function (Auto Print)

(only possible with non verifiable setting)

Using the Auto Print function ensures automatic data printing without necessity to

press the  key for each single measurement. If the function is activated, the **AP** (Auto-Print) symbol is displayed.

It is possible to select from six types of automatic printing. Information concerning setting the zero range can be found in chapter 11.7

Printing at loading:

Select the menu element **42** in the menu overview.

Place the sample when the displayed value lies within the zero range. The data will be output automatically when the → stabilisation symbol is illuminated and the displayed positive value exceeds 5 times the zero range value. The next data output will occur when the display is brought to the value within the zero range by removing the

sample or pressing the  key.

Printing at loading and unloading:

Select the menu element **43** in the menu overview.

Place or remove the sample when the displayed value lies within the zero range. The data will be output automatically when the → stabilisation symbol is illuminated and the displayed positive or negative value exceeds 5 times the zero range value. The next data output will occur when the display is brought to the value within the zero

range by removing the sample or pressing the  key.

Printing at loading and zero:

Select the menu element **44** in the menu overview.

Place the sample when the displayed value lies within the zero range. The data will be output automatically when the → stabilisation symbol is illuminated and the displayed positive value exceeds 5 times the zero range value. Remove the sample or

press the  key. The data will be output again when the displayed value lies within the zero range and the → stabilisation symbol is illuminated.



Printing at loading, unloading and zero:

Select the menu element **45** in the menu overview.

Place the sample when the displayed value lies within the zero range. The data will be output automatically when the → stabilisation symbol is illuminated and the displayed positive or negative value exceeds 5 times the zero range value. Remove the

sample or press the  key. The data will be output again when the displayed value lies within the zero range and the → stabilisation symbol is illuminated.

14.5 Taring/printing at stability (models PBJ)

Before pressing the  key or displaying the zero point by pressing the  key, make sure that the balance is stabilised first.

To carry out printing or taring without waiting for the balance stabilisation:
(immediate mode)





- Select the menu element **39**.

If printing or taring is to be carried out after the balance stabilisation: (waiting for the stability)



- Select the menu element **40**.

Note:







While the weight is waiting for the stability, the „----” symbol is displayed.

- When the  key is pressed, the „----” symbol is displayed. If the function is to be deactivated and taring interrupted, press the  key.
- When the  communication symbol and STAND-BY mode symbol are displayed and the  key is pressed, wait until the → stabilisation display appears. The data will be sent when the → stabilisation display appears. If the  key is pressed during the waiting time, the balance is switched over to the stand-by mode. The data will be printed when stability is reached in the next weighing process.

14.6 Recipe mode

This mode is used for convenient weighing of individual recipe components. Weights of each component are displayed and saved after each pressing the  key. The weights of those components are sent with the RS-232C or DATA I/O interface, and the display is automatically zeroed to weigh the next component. When all components are weighed, their weights are added up and the total weight is displayed. This value output is carried out with the  key.









Select the menu element **51** in the menu overview.

- 1. If the recipe mode is activated, the display is in the recipe stand-by mode until it is started. The display shows the Add-On symbol, memory symbol and stand-by mode symbol. Place the container (if used) and press the  key to tare it. Please remember that taring with the  key will not be accepted after previous pressing the  key (as in the step 2). Taring is possible again after previous pressing the  key (as in the step 5).
- 2. Press the  key. If a peripheral device is connected, the „----- RECIPE MODE -----” command will be given.
- 3. Place the first component and then press the  key. The weight value will be output as „CMP001”. After finishing, the display will be automatically zeroed.
- 4. Step 3 is to be repeated for all components to be weighed.
- 5. Then press the  key. The total weight will be displayed and output to peripheral devices with the „TOTAL=” unit.
- 6. Remove everything from the balance plate. The next recipe is started from the step 1.



14.7 Automatic saving and zeroing

This function is used for weighing large number of single samples. If the function is activated, the  automatic saving and zeroing symbol is illuminated.

Select the menu element **52** in the menu overview.

- Place the container to be weighed on the balance and press the  key when the automatic saving and zeroing function is in the stand-by mode. (The  automatic saving and zeroing symbol and STAND-BY mode symbol are illuminated.)
The balance will be zeroed.
Press the  key. The stand-by symbol disappears and measurements within the automatic saving and zeroing function can be started.
- Place the first sample on the scale pan. Each time when the  stabilisation symbol is illuminated and the value corresponding to five times the zero range or higher is illuminated or when the  key is pressed, the illuminating value output and balance zeroing is carried out.
- Weighing process of the next sample is carried out without the necessity to press the  key.
- Press the  key. The balance returns to the stand-by mode of the automatic saving and zeroing function, the total weight placed on the scale pan without the packaging weight is displayed. To print this value, press the  key.

Note:

- If the stabilisation symbol is illuminated and the display value lies within the zero range, zeroing is carried out automatically.
- Pressing the  key when the display value lies below five times the zero range is followed by zeroing after data output. (Manual loading)
- Pressing the  key when the automatic saving and zeroing function is in stand-by mode is also followed by setting mains supply in stand-by mode.

14.8 Animal weighing

(only possible with non verifiable setting)

This function is used for weighing animals. The animal symbol  is displayed when the animal weighing mode is active.

Select the menu element **53** in the menu overview.



- Place the weighing container on the scale pan and press the  key.

Note:

When the weighing container is placed on the scale pan, data output is possible. It is not a fault.

- Place an animal on the scale pan. Its weight must exceed 50 times the zero range.
- The value will be given automatically when the weighing value is stabilised.
- Press the  key or remove an animal from the scale pan.
- If the displayed value is stable, but it lies below 10 times of the zero range, the balance will be zeroed automatically. Any remaining materials on the scale pan (excrement or skin) will be automatically written off and zeroed. If the balance is not zeroed, the zero range value must be increased (refer to chapter 10.7).

Note:

- The stand-by mode is not provided for the animal weighing function.
- Press the  key to switch over to the mains supply stand-by mode.
- When live animals are weighed in the animal weighing mode, automatic extension of stability detection band is carried out. Repeatability of measuring data is a bit lower than in other operational modes.
- If an animal being weighed cannot be controlled and the automatic printing function does not respond, you can press the  key to output the display value. Then remove an animal from the balance. Even if the stability symbol appears before an animal is removed from the balance, the data will not be printed again.
- The stability symbol will appear earlier due to setting the wider stability detection band in the menu.
- If the balance returns to the zero point too slowly, the zero range is to be set to a higher value.
- The initial taring function (chapter 11.2.1) cannot be used together with the animal weighing function.

15 Data output

15.1 Computer – RS-232C

15.1.1 Cable connection

NOTE:

By using the RS-232C/AUX interface of the PBS/PBJ type balances it is also possible to output other signals than RS-232C ones. Incorrect connection of those signal cables may lead to the computer or balance failure. Therefore, make sure that the suitable and correctly connected cable provides communication between the balance and computer.

Some types of computers may not operate normally when they are connected by using the optional RS-232C cable in the way shown in the below figure.

(1) IBM PC/AT computer and compatible (9-pin D-sub connector)

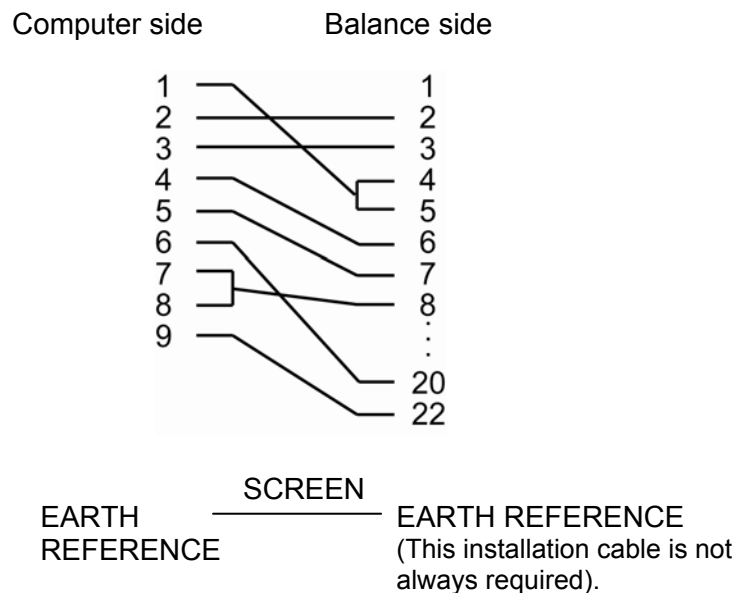

(2) IEEE standard (25-pin D-sub connector)

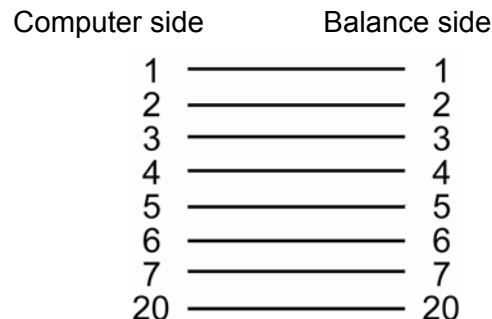

15.2 Data formats

The following explanations refer to the case when the menu element **77** (EB type format) is selected. Explanations concerning other formats are included in the data of computers compatible with the suitable data formats.

Note:

The mark indicates the space code, and <Limiter> indicates the limiter code.

1. For measuring values:

First sign minus: '-', not minus: space

From 2. to 11. sign: Numerical values or „[“, ”]” are right justified. Position of the decimal point is changed depending on the device type.

From 12. to 13. sign: units, for example: g or kg

From 14. to 15. sign: limiter

Note:

- If the CR or LF command is the limiter (the menu element **94** or **95** is selected), sign 13 is not available.
- When stability information is printed, the first of the above mentioned signs is preceded with the following sign:
Stable time: S
Unstable time: D

2. For „oL” or „-oL”

„oL” OL <Limiter>

„-oL” – OL <Limiter>

15.3 Using codes of commands

Note:

Incorrect setting of communication parameters results in displaying the communication error „ComErr”.

1. Commands ending with a digit, letter or symbol different than [=]:

commands to the balance must be transmitted with a limiter for each command code.

Example 1:

PRINT<CR> ... The same process as after pressing the



key.

2. Commands ending with the [=] sign: Digits must be transmitted with a limiter to the balance.

Example 2:

TIME=1234 <CR> .. The time of 12:34 is set as the current time.

Example 3:

P.TARE=1.23 <CR> (example for two positions after the point).
The value of 1,23 g is set as the initial taring value.

Example 4:

P.TARE=0.00 <CR> (example for two positions after the point).
... cancels (writes off) the initial taring value.

Note:

Number of positions, decimal point and position of the decimal point in the number sign transmitted after the '=' sign are the same as they would be for entering numerical value with the keyboard.

Use the same number of places after the point as in the weighing mode.

This limitation does not refer to USER=, SOLID= and LIQUID= commands.

Note:

- If 0 is at the beginning of the four-position number, the setting is finished at this point, and the menu selection is finished.
- The result of such a command depends on the balance type.

Example 6: #=2.56 <CR>

Example 7: #=12.345.67 <CR>

A computer makes it possible to determine the specified presentation way of numbers for processes of weighing and displaying on the balance.

In the case of commands from examples 6 and 7, the values of [#2.56] and [#12.345.67] are displayed on the balance. When the



key is pressed, the '2-56<CR>' and '12-345-67<CR>' strings are sent from the balance.

3. Return message command

The balance sends back the N string of signs which are limited by the return message command '{' or '}' and limiter.

In the receive buffer of the balance there are not left any not processed return message commands for $N \leq 30$.

Example 8: ABCDEFG12345<CR>











... When this command is received, the balance sends ABCDEFG12345<CR> string. This string can be printed by the printer.

Note:

Only capital letters and part of symbols (decimal point, decimal symbol etc.) can be used for data output with an electronic printer. Maximal length of line is 15 characters.

4. Codes of commands for EB type formats (the menu element 77) and Old EB type (the menu element 78)**(i) Output commands**

D01	Continuous output
D03	Continuous output with stability information
D05	Single output
D06	Automatic printing setting (type of automatic printing is set separately)
D07	Single output with stability information
D09	Cancellation of continuous output and automatic printing

(ii) Commands concerning user keys	
POWER	Corresponds to the  key.
Q	Corresponds to the  key.
MENU	Corresponds to the  key.
TARE	Corresponds to the  key.
T	Corresponds to the  key.
UNIT	Corresponds to the  key.
PRINT	Corresponds to the  key.
POWER+	Corresponds to holding the  key for about 3 seconds.
MENU+	Corresponds to holding the  key for about 3 seconds.
UNIT+	Corresponds to holding the  key for about 3 seconds.
PRINT+	Corresponds to holding the  key for about 3 seconds.

(iii) Commands concerning user measurements	
ADDON	Sets automatic saving and zeroing mode.
+	Comes into use immediately after setting the automatic saving and zeroing mode.
A	Sets animal weighing mode.
ANIMAL	Sets animal weighing mode.
R	Cancel user weighing mode.

(iv) Commands concerning conversion of units	
g	Switches over to „g” unit.
kg	Registration of „kg” unit and switching over.
PERCENT	Registration of „%” unit and switching over.
%	Sets 100% when displaying is carried out in „%” unit.
G	g - % switching over.
PCS	Registration of „PCS” unit and switching over.
CT	Registration of „CT” unit and switching over.
SDENSE	Registration of „Solid density” unit and switching over.
LDENSE	Registration of „Liquid density” unit and switching over.
RSTUNIT	Return to the standard settings.

(v) Reading commands for set values	
TARGET	Readout of the set target value.
LIMIT	Readout of the set limit value.
G.LO	Readout of the set lower limit value on the display of the check weighing 1.
G.UP	Readout of the set upper limit value on the display of the check weighing 1.
L.LO	Readout of the set lower limit value on the display of the check weighing 2.
L.UP	Readout of the set upper limit value on the display of the check weighing 2.
UW	Readout of the set value for weight unit.
G/PCS	Corresponds to the „g/PCS” key.
CALWIT	Readout of the set external weight value for calibration of measuring range.
ACALT1	Readout of time 1 in the Clock-CAL mode.
ACALT2	Readout of time 2 in the Clock-CAL mode.
ACALT3	Readout of time 3 in the Clock-CAL mode.
P.TARE	Readout of the set initial taring value.
ZRNG	Readout of the set zero range value.
USER	Readout of conversion factors for the user unit.
VOL	Readout of the set value for reference weight.
DENSE	Readout of the set value for ambient liquid density.
ITIME	Readout of the set value for interval timer.

(vi) Commands for setting numerical values	
CALWIT=	Sets external weight value for calibration of measuring range.
ACALT1=	Sets time 1 in the Clock-CAL mode.
ACALT2=	Sets time 2 in the Clock-CAL mode.
ACALT3=	Sets time 3 in the Clock-CAL mode.
UW=	Sets weight unit.
VOL=	Sets volume of reference weight.
SDENSE=	Sets density of ambient liquid.
DATE=	Sets date.
TIME=	Sets time.
TARGET=	Sets target value.
LIMIT	Sets limit value.
G.LO=	Sets lower limit value on the display of the check weighing 1.
G.UP=	Sets upper limit value on the display of the check weighing 1.
L.LO=	Sets lower limit value on the display of the check weighing 2.
L.UP=	Sets upper limit value on the display of the check weighing 2.
PCS=	Sets any number of pieces.
#=	Corresponds to numeric keys of the keyboard.
ID=	Specifies ID.

(vii) Commands of special functions	
CAL	Calls up measuring range calibration mode.
C18	Calls up measuring range calibration mode.
LOCK	Sets menu lockout.
RELEASE	Releases menu lockout.
TIME	Reads date and time.
ADJCLK	Carries out correction by ± 30 seconds.
RSTMN	Manu return.
MENU=	Makes it possible to call up any menu.
{	Return message.
}	Return message.
[@]	Switches over to the multipoint connection mode. (@ for small letters)

5. Commands compatible with Mettler Toledo series electronic balances	
S	Single output in stable condition
SI	Immediate, single output
SIR	Continuous output
SR	Continuous output in stable condition
T	Taring after stabilisation
TI	Immediate taring
Z	Zeroing (the same as immediate taring)

5. Commands compatible with Sartorius series electronic balances	
<ESC>P	Single taring
<ESC>T	Taring

Note:

<ESC> for output code (1BH)

15.4 Operator settings

15.4.1 Overview

This menu is used to determine technical data of communication between the balance and a computer or electronic printer.

Note:

This menu applies both to the RS-232C interface and DATA I/O interface.

For the device to which the DATA I/O interface is connected e.g. electronic printer, the balance communication parameters should be set to the standard settings i.e. select the following menu elements: **76, 77, 83, 89, 92, 94**.

15.4.2 Handshaking

The handshake function determines whether or not peripheral devices can receive communication data from the balance. It does not transfer the balance status to the peripheral devices. The balance can receive data as long as there is a free space in its receive buffer memory. This function is ready for operation when the „oFF” symbol is displayed. Its reliable operation in other states cannot be guaranteed.

If the balance data output is interrupted by the handshake function, the balance display is locked.

Enter the suitable settings for the handshake function.

If the software handshake function is not to be performed, select the menu element **73**

If the software handshake function is to be performed in the way described below, select the menu element **74**

- When the X-OFF (13H) command is received by the balance, the balance data output is stopped.
- When the X-ON (11H) command is received by the balance, the balance data output is started.

If the hardware handshake function is to be performed in the way described below, select the menu element **75**

- If the DTR parameter is set to OFF, the balance data output is stopped.
- If the DTR parameter is set to ON, the balance data output is started.

To call up the time controlled hardware handshake function, select the menu element **76**

15.4.3 Format

Specify the format of data output by the balance.

For the standard format of the KERN electronic balances:

- select menu element **77**.

For the old data output format of the KERN electronic balances:

- select the menu element **78**.

15.4.4 Transmission speed

Specify the transmission speed (300, 600, 1200, 2400, 4800, 9600, 19200 or 38400 bps).

The value presented as „b-xxx” gives the number of bps (bits/second). Baud-rate and bps are the same value.

Select one of the menu elements from **81** to **88**.

15.4.5 Parity / bit length

Select the parity and bit length.

No parity, 8-bit length:

Select the menu element **89**

Reverse parity, 7- bit length:

Select the menu element **90**

Simple parity, 7- bit length:

Select the menu element **91**

15.4.6 Stop bits

Select the number of stop bits.

Stop bit 1:

Select the menu element **92**

Stop bit 2:

Select the menu element **93**

15.4.7 Limiter

The „limiter” is used to separate single data or commands from each other. The limiter is to be set in the following way:

Setting to CR(0DH):

Select the menu element **94**

Setting to LF(0AH):

Select the menu element **95**

Setting to CR+LF(0D0AH):

Select the menu element **96**

16 Service, maintenance, disposal

16.1 Cleaning

Please disconnect the device from the power supply source before cleaning.

Do not use aggressive cleaning agents (solvents or similar agents), but a cloth dampened with mild soap suds. Ensure that no liquid penetrates into the device and wipe with a dry soft cloth.

Loose sample residue/powder can be removed carefully using a brush or hand vacuum cleaner.

Remove any spilt material to be weighed immediately.

16.2 Service, maintenance

The device may only be opened and maintained by trained service technicians who are authorised by KERN.

Disconnect the balance from mains supply before its opening.

16.3 Disposal

Disposal of packaging and device must be carried out by operator according to valid national or regional law of the location where the device is used.











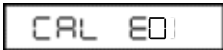

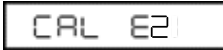
17 Help in case of small faults

In case of a fault in the program sequence, the balance should be shortly switched off. The weighing process must then be restarted from the beginning.

General displays:

Display	Explanations
---	Wait for the next display.
- 10d -	Resolution of the minimal display has been reduced by one position.
- 1d -	The minimal display returns to the initial number of positions.
-t ime-	Date and time are output.
Abort	The process has been interrupted.
APl End	Operational measurement is allowed.
d ouEr	Too large error was found during calibration check. (Please contact your sales representative.)
d UndEr	Too large error was found during calibration check. (Please contact your sales representative.)
LoCKEd	Menu lockout is active.
rELEASE	Menu lockout is released.
rESEt	The menu has been reset.
SEt	The contents of the new setting and factor have been saved.
aFF	Return in a result of mains failure.
wR it	The built-in weight is moving. Please wait.
All number signs are flashing.	Put the calibration weight being displayed.

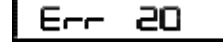
Displaying errors:

Displayed codes of errors	Explanation	Remedy
	Disturbances in weight loading mechanical elements.	Check transport screws.
	Weight on the scale pan is unstable during calibration.	
	Large zero point drift during calibration.	Empty the scale pan.
	Large drift during the PCAL function.	Use the correct weight.
	Large drift during calibration of the measuring range.	Use the correct weight.
	Calibration weight is incorrect.	Use the correct weight.
	Disturbances in the balance (the balance is stopped when this display appears).	*
	The received command code is incorrect.	Check limiters etc.
	Total number of the displayed unit is longer than 7 positions.	Reduce the weight.
	Disturbance in the balance.	*
	Password error of the PCAL function.	Check the password.
	Incorrect mains voltage.	Check mains voltage.

* Please contact your sales representative.

Troubleshooting:

Symptoms	Possible cause	Remedy
Display is empty.	<ul style="list-style-type: none">• Mains adapter is not connected.• The room mains circuit-breaker is switched off.• Incorrect voltage.	Check mains voltage and connect the mains adapter correctly.
„OL” or „-OL” display	The transport screws are not locked. Pads of the scale pan not installed. Too large weight on the scale pan.	Turn the screws anticlockwise until they are locked. Install pads of the scale pan. Use the weight within its capacity.
The display does not react after putting a weight on the scale pan.	The scale pan is displaced.	Place the scale pan correctly.
The display fluctuates.	Influence of vibrations or air stream. Protective shield is touching the scale pan.	Place the weight at the suitable location. Try to change environment settings. Install the shield on the main unit of the balance.
Incorrect weighing result.	Calibration of the measuring range is not effective. Taring is not effective.	Calibrate the weight correctly. Tare the balance before weighing.
The balance does not display the required unit.	The unit has not been set.	First set the unit.
Selection of the menu element is rejected.	Menu lockout is ACTIVATED.	Release the menu lockout.