

# Orthopantomograph® OP200 & OP200 D Orthoceph® OC200 & OC200 D Service Program Manual





**Copyright**

Code: 5140241-100 rev 3 Date: 15 May 2008  
Document code: D500293 rev 3

Copyright © 05/2008 by PaloDEx Group Oy.  
All rights reserved.

Orthopantomograph® and Orthoceph® are registered trademarks of Instrumentarium Dental. U.S. patents 4,641,336; 5,016,264; 5,425,065, 5,444,754, 6,731,717 and 6,829,326. German patent 4,344,745. Finnish patents 112594 and 114383. Windows® is trademark of Microsoft Corporation in the United States of America and other countries. Pentium® is a registered trademark of Intel Corporation. Iomega® Jaz® is a registered trademark of Iomega Corp.

Documentation, trademark and the software are copyrighted with all rights reserved. Under the copyright laws the documentation may not be copied, photocopied, reproduced, translated, or reduced to any electronic medium or machine readable form in whole or part, without the prior written permission of Instrumentarium Dental.

The original language of this manual is English.

Instrumentarium Dental reserves the right to make changes in specification and features shown herein, or discontinue the product described at any time without notice or obligation. Contact your Instrumentarium Dental representative for the most current information.

CE  
0537

**Manufactured by**

Instrumentarium Dental  
Nahkelantie 160 (P.O. Box 20)  
FI-04300 Tuusula  
FINLAND  
Tel. +358 45 7882 2000  
Fax. +358 9 851 4048

For service, contact your local distributor.



---

# Table of Contents

|          |   |          |
|----------|---|----------|
| <b>1</b> | <b>Introduction</b> .....   | <b>1</b> |
| 1.1      | General .....   | 1        |
| 1.2      | Exhibition mode.....  | 1        |
| 1.3      | Service program quick reference .....   | 2        |
| 1.4      | How to use the service programs.....  | 4        |
| <b>2</b> | <b>Service program features</b> .....   | <b>5</b> |
| 2.1      | Sr 70 Log: Display error log .....  | 5        |
| 2.2      | Sr 71 PAy: Set lease period .....   | 7        |
| 2.3      | Sr 72 LCA: Adjust lateral TMJ image area<br>(film units only) .....                         | 8        |
| 2.4      | Sr 74 IOC: Display CPU input/output signal check .....                                      | 10       |
| 2.5      | Sr 76 PUP: X-ray tube warm-up.....  | 16       |
| 2.6      | Sr 77 Prh: Adjust the preheat setting .....   | 18       |
| 2.7      | Sr 78 thA: Set Dose Calibration Constant (DCC).....   | 19       |
| 2.8      | Sr 79 SUP: Display line voltage .....   | 20       |
| 2.9      | Sr 80 CrL: Test motor movement.....   | 20       |
| 2.10     | Sr 81 bPL: Display biteplate properties<br>(Volumetric Tomography option only) .....        | 22       |
| 2.11     | Sr 82 COL: Set/display collimator information .....   | 23       |
| 2.12     | Sr 86 Sto: Store settings .....   | 25       |
| 2.13     | Sr 87 LAL: Set linear adjustment value for VT .....   | 25       |
| 2.14     | Sr 88 CAL: Disable automatic cephalostat alignment correction<br>(digital units only) ..... | 26       |
| 2.15     | Sr 88 CAL: Set cephalostat alignment value (film units only) .....                          | 27       |
| 2.16     | Sr 89 COP: Set country options .....  | 27       |
| 2.17     | Sr 90 PIN: Panorama installation program.....   | 30       |
| 2.18     | Sr 91 CIN: Cephalostat installation program (digital units only).....                       | 31       |
| 2.19     | Sr 92 CHE: Set level of self-checks .....   | 32       |
| 2.20     | Sr 93 BAL: Adjust beam alignment board sensitivity .....                                    | 33       |

Approved

# 1 Introduction

## 1.1 General

Instrumentarium Dental Ortopantomograph® OP200 is a panoramic X-ray unit to produce images of the dentition, TM-joints and skull (hereafter called “OP200”).

OP200 has two kinds of programs, user programs (Pr) and service programs (Sr).

User programs (Pr) are accessible by the user and allows unit configuration for daily use and changing technique factors to optimize image quality. See *OP200 User Manual*.

Maintenance & Service programs (Sr) are intended for technical personnel for use during installation and service.



The **Pr** and **Sr** letters in the kV display indicate the unit in user or service programming mode. The mA display indicate number of the currently selected program. Each program has a short name describing its purpose in the time/dose display.

## 1.2 Exhibition mode

OP200 has a special *exhibition* mode in which no X-ray radiation is generated. It is activated by setting the I/O board jumper X11 to **ON**.

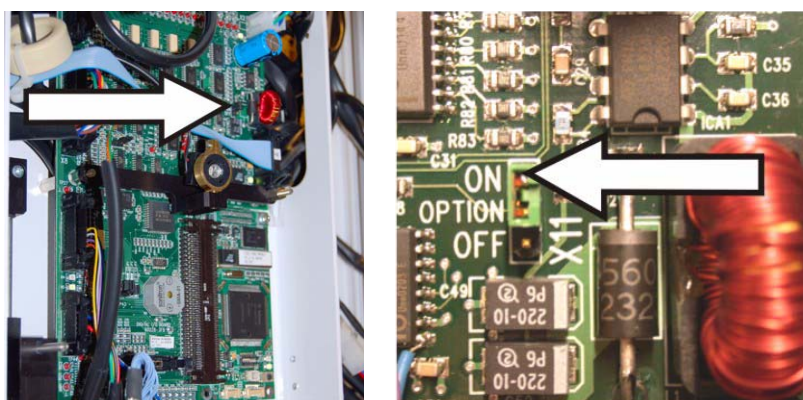





### 1.3 Service program quick reference

| <b>SERVICE PROGRAM<br/>REFERENCE TABLE</b> |   |
|--|---|
| Sr<br>70<br>Log                            | ERROR LOG PROGRAM<br>Display failure counters.  |
| Sr<br>71<br>PAy                            | SET TRIAL PERIOD LIMIT<br>Set the length of the trial period (lease time).  |
| Sr<br>72<br>LCA                            | LATERAL CASSETTE ADJUSTMENT<br>(Film units only)<br>Adjust the symmetry of TMJ image areas.                                     |
| Sr<br>74<br>IOC                            | INPUT / OUTPUT SIGNAL CHECK<br>Display the states of the CPU's input/output signals.  |
| Sr<br>76<br>PUP                            | WARMING UP SEQUENCE<br>Warm up the X-ray tube after installation or when the unit has not been used in a while.                 |
| Sr<br>77<br>Prh                            | PREHEAT ADJUSTMENT<br>Perform an automatic preheat adjustment.  |
| Sr<br>78<br>thA                            | DOSE CALIBRATION CONSTANT SELECTION<br>Set the dose calibration constant according to the tubehead's dose rate.                 |
| Sr<br>79<br>SUP                            | LINE VOLTAGE DISPLAY<br>Display the line voltage.   |
| Sr<br>80<br>CrL                            | INDIVIDUAL MOTOR MOVEMENT TESTS<br>Test drive individual motors to ensure proper operation.                                     |
| Sr<br>81<br>bPL                            | BITEPLATE TEST PROGRAM<br>Display the currently attached biteplate and the corresponding input voltages (only with VT enabled). |
| Sr<br>82<br>COL                            | COLLIMATOR INFORMATION PROGRAM<br>Display collimator configuration and I/O signal states.                                       |
| Sr<br>87<br>LAL                            | LINEAR ADJUSTMENT VALUE<br>Adjust the linear position of the sharp layer in VT images (only with VT enabled).                   |



| <b>SERVICE PROGRAM<br/>REFERENCE TABLE</b> |   |
|--|---|
| Sr<br>88<br>CAL                            | <p><i>Digital units:</i> SECONDARY COLLIMATOR ALIGNMENT</p> <p><i>Film units:</i> CEPHALOSTAT BEAM ALIGNMENT<br/>Adjust the horizontal position the x-ray beam in cephalometric imaging programs.</p> |
| Sr<br>89<br>COP                            | COUNTRY OPTIONS<br>Configure the unit according to installed options, country specific regulations and user preferences.  |
| Sr<br>90<br>Pln                            | PANORAMA INSTALLATION PROGRAM<br>Adjust the AEC sensitivity and collimator alignment for panoramic imaging.   |
| Sr<br>91<br>Cln                            | CEPH INSTALLATION PROGRAM<br>Adjust the alignment for cephalometric imaging.  |
| Sr<br>92<br>ChE                            | DISABLE/ENABLE CHECKS<br>Temporarily bypass self-checks performed by the unit.  |
| Sr<br>93<br>bAL                            | BEAM ALIGNMENT BOARD ADJUSTMENT<br>Adjust the sensitivity of the beam alignment board.  |

## 1.4 How to use the service programs

1. Turn the unit on.
2. Press (hold for five seconds)  OK to enter user programming mode.
3. Press the left and right button to enter service programming mode in the following order:  
press and hold left,  
press and hold right,  
release left, release right.  
A tone confirms that service mode is entered.
4. Press the up button to scroll pass the user programs and to access the service programs.
5. Press the up and down buttons to scroll the list of service programs. Select the desired **Sr** program by pressing **OK**.  
 
6. See chapter 2 Service program features on how to use the programs.
7. Press  OK to exit the program.

**NOTE!** *Changed settings are stored when a program is exited if not stated otherwise in the program description. If the unit is switched off while a program is still running, the settings may not be stored.*

8. Press (and hold for five seconds) OK to enter back to normal operating mode.

**WARNING!** *Always reset the unit by switching power off and on again after accessing the service programming mode. This prevents unauthorized access to service programs and leaves the unit in state that is safe for the user and patient.*

## 2 Service program features

### 2.1 Sr 70 Log: Display error log

Each time a failure occurs in OP200, a counter corresponding to the failure is incremented. This program is used to view the readings of these counters.

**NOTE!** Only failures that are relevant for troubleshooting and failure diagnostics are recorded (see the table below for details). Some failure counters have non-zero values at the time of installation. This is normal.



1. Select **Sr 70 Log**.
2. Press the up and down buttons to scroll the list of counters. The control panel shows the current counter, continually switching between its failure code and counter value.



3. Press OK to exit the program.

|                                   | FILM UNIT OP200                   |  | DIGITAL UNIT OP200 D              |  |
|-----------------------------------|-----------------------------------|--|-----------------------------------|--|
| kV-<br>display<br>Ch / Sy /<br>Er | mA-<br>display<br>error<br>number | Second /<br>dose -<br>display<br>Error name<br>FILM UNIT | mA-<br>display<br>error<br>number | Second /<br>dose -<br>display<br>Error name<br>DIGITAL<br>UNIT |
| Ch                                | 5                                 | ***<br>LINE VOLTAGE                                      | 5                                 | ***<br>LINE VOLTAGE  |
| Ch                                |                                   |  | 13                                | LbL<br>IMAGE LABEL<br>FAILURE                                  |
| Ch                                | 16                                | StP<br>EMERGENCY<br>SWITCH                               | 16                                | StP<br>EMERGENCY<br>SWITCH                                     |
| Sy                                | 21                                | HHo<br>TUBEHEAD<br>HOT                                   | 21                                | HHo<br>TUBEHEAD<br>HOT   |

|                                       | FILM UNIT OP200                       |  | DIGITAL UNIT OP200 D                  |  |
|---------------------------------------|---------------------------------------|--|---------------------------------------|--|
| kV-<br>display<br><br>Ch / Sy /<br>Er | mA-<br>display<br><br>error<br>number | Second /<br>dose -<br>display                    | mA-<br>display<br><br>error<br>number | Second /<br>dose -<br>display            |
|                                       |                                       | Error name<br>FILM UNIT                          |                                       | Error name<br>DIGITAL<br>UNIT            |
| Sy                                    | 22                                    | Arc<br>TUBEHEAD<br>ARC                           | 22                                    | Arc<br>TUBEHEAD<br>ARC                   |
| Sy                                    | 23                                    | Inu<br>INVERTER<br>FAILURE                       | 23                                    | Inu<br>INVERTER<br>FAILURE               |
| Sy                                    | 24                                    | FIL<br>FILAMENT<br>FAILURE                       | 24                                    | FIL<br>FILAMENT<br>FAILURE               |
| Sy                                    | 25                                    | AEC<br>AEC<br>FREQUENCY<br>ERROR                 | 25                                    | AEC<br>AEC<br>FREQUENCY<br>ERROR         |
| Sy                                    | 27                                    | Por<br>ROTATION<br>MOVEMENT<br>FAILURE           | 27                                    | Por<br>ROTATION<br>MOVEMENT<br>FAILURE   |
| Sy                                    | 28                                    | PoC<br>CASSETTE<br>MOVEMENT<br>FAILURE           | 28                                    | CCd<br>CAMERA<br>ERROR                   |
| Sy                                    | 29                                    | PoL<br>LINEAR<br>MOVEMENT<br>FAILURE             | 29                                    | PoL<br>LINEAR<br>MOVEMENT<br>FAILURE     |
| Sy                                    | 30                                    | PoH<br>CASSETTE<br>HOLDER<br>MOVEMENT<br>FAILURE | 30                                    | PoC<br>CEPH<br>MOVEMENT<br>FAILURE       |
| Sy                                    | 31                                    | PoU<br>Z MOVEMENT<br>FAILURE                     | 31                                    | PoU<br>Z MOVEMENT<br>FAILURE             |
| Sy                                    |                                       |  | 32                                    | PoA<br>CEPH BEAM<br>ALIGNMENT<br>FAILURE |
| Sy                                    | 33                                    | nSy<br>NO SYNC<br>ERROR                          | 33                                    | nSy<br>NO SYNC<br>ERROR                  |
| Sy                                    |                                       |  | 34                                    |  |

|                 | FILM UNIT OP200 |                                       | DIGITAL UNIT OP200 D |                                       |
|-----------------|-----------------|---------------------------------------|----------------------|---------------------------------------|
| kV-<br>display  | mA-<br>display  | Second /<br>dose -<br>display         | mA-<br>display       | Second /<br>dose -<br>display         |
| Ch / Sy /<br>Er | error<br>number | Error name<br>FILM UNIT               | error<br>number      | Error name<br>DIGITAL<br>UNIT         |
| Sy              |                 |                                       | 35                   |                                       |
| Sy              |                 |                                       | 36                   |                                       |
| Sy              |                 |                                       | 37                   |                                       |
| Sy              |                 |                                       | 38                   | COL<br>AUTO-<br>COLLIMATOR<br>FAILURE |
| Er              | 40              | CPU<br>CPU ERROR                      | 40                   | CPU<br>CPU ERROR                      |
| Er              | 43              | ***<br>MAINS SWITCH                   | 43                   | ***<br>MAINS SWITCH                   |
| Er              | 44              | FIL<br>FILAMENT<br>REFERENCE<br>ERROR | 44                   | FIL<br>FILAMENT<br>REFERENCE<br>ERROR |
| Er              | 45              | InP<br>INPUT ERROR                    | 45                   | InP<br>INPUT ERROR                    |

## 2.2 Sr 71 P<sub>A</sub>y: Set lease period

Allows limited quantity of exposures. After this exposure is prohibited and the control panel displays **Er 46 P<sub>A</sub>y** message. For equipment leasing and trial period purposes.



The lease number can be set within the range 0...2000 or to the special value **OFF** (feature disabled). Number zero (0) activates **Er 46 P<sub>A</sub>y**, which prevents exposures. Other numbers adjust the stored exposure counter into a number above the total exposure count.

Press OK to test if test limit has been set in normal operation. The cumulative exposure counter value is shown, followed by the number of allowed exposures (all indicators are lit).

**NOTE!** *The trial period refers to the number of exposures allowed in normal operating or QA mode. Exposures made while the unit is in service mode are compensated automatically.*

Usage:

1. Select **Sr 71 Pay**. The time/dose display shows **OFF** or a number from **1** to **2000**.
2. Disable the lease period feature or select the desired lease period using the left and right buttons.
3. Press OK to exit the program.



### 2.3 Sr 72 LCA: Adjust lateral TMJ image area (film units only)

For adjusting the horizontal alignment of TMJ image areas on the film.



With imaging program P7 (TMJ Lateral view jaw closed and open), the two first images are shown on the edges of the film. The next two are shown in the middle of the film. The center image area can be adjusted in respect to the other image pair. The adjustment range is -10...+10 mm, in steps of 0.5 mm.

Usage:

1. Select **Sr 72 LCA**. Use the customer's latest TMJ Lateral view jaw closed and open X-ray image, or take a new image.
2. Select imaging program P7 and the lowest technique factors. Make an exposure and process the film.

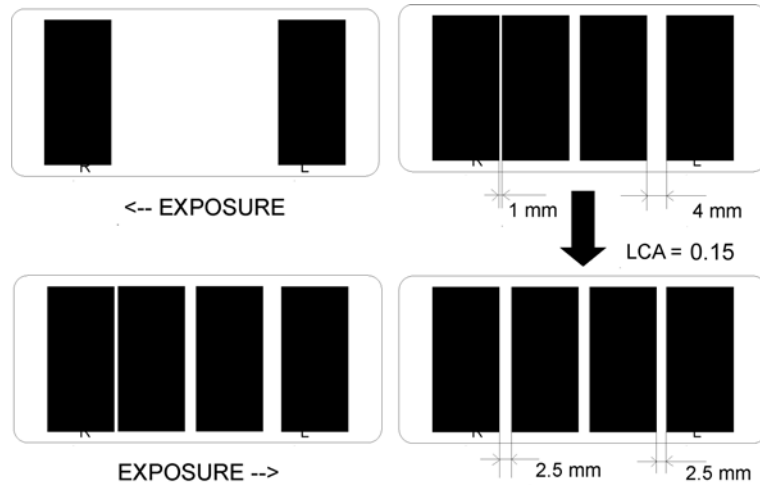

3. Check the film for center image pair symmetry. Calculate the amount (-0.25...+1.00 cm) of correction needed.
4. Select **Sr 72 LCA**. The control panel shows a number from **-0.25** to **1.00**. The number indicates the adjustment of the positioning of the second image pair areas (center) compared to the first image pair areas (on each side).
5. Use the left and right buttons to shift the middle image pair to the left / right in steps of 0.5 mm.
6. Press OK to exit the program.
7. Enter the normal operating mode. Make an exposure and process the film. Check the film for symmetry. If the result is not satisfactory, return to **Sr 72 LCA** and repeat the steps 1 to 7.

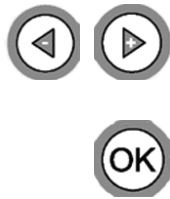

## 2.4 Sr 74 IOC: Display CPU input/output signal check

For checking input and output signal states as seen by the CPU. Check whether a signal reaches the CPU correctly, when troubleshooting electrical problems related to e.g. microswitches and buttons.



The I/O signals are divided into several pages, named 0L - 0H - 1L - 1H - 2L - 2H - 3L - 3H - 4L - 4H - 5L - 5H - 6L - 6H. The tables below describe the signals shown on each page.

The current page is shown on the kV/mA displays. Individual signal states are shown as on/off signals by the imaging program LEDs. A LED being lit means that the corresponding signal is active. A hexadecimal number summarizing the whole page is shown on the time/dose display.

Usage:



1. Select **Sr 74 IOC**.
2. Use the left and right buttons to select page.
3. Check if the signal state shown on the control panel matches the corresponding electrical signal level. If not, the signal does not reach the CPU correctly.
4. Decide signal states according to the tables. For trouble shooting electrical connections, use the CPU board schematics to trace the signals.

**NOTE!** *The control panel display is updated with a small delay. Remember this when interpreting frequently changing signals.*



5. Press OK to exit the program.



| <b>Sr 74 IOC, page 0L</b> |  |     |
|---------------------------|--|-----|
| Signal name               | Description<br>(Status, when the LED is lit) | LED |
| PROJLIT                   | Projector lights (on)                        | 1   |
| PILLED                    | Layer adjustment led, closest to pillar      | 5   |
| CENLED                    | Layer adjustment led, center                 | 6   |
| PATLED                    | Layer adjustment led, closest to patient     | 7   |

| <b>Sr 74 IOC, page 0H</b> |  |     |
|---------------------------|--|-----|
| Signal name               | Description<br>(Status, when the LED is lit) | LED |
| LASLIT                    | Panorama laser lights                        | 2   |
| ZDIR                      | Vertical movement direction<br>(down)        | 5   |
| ZENA                      | Vertical movement enable                     | 6   |
| RACKDIR                   | Rack movement direction (up)                 | 7   |
| RACKENA                   | Rack movement enable                         | 8   |

| <b>Sr 74 IOC, Input page 1L</b> |  |     |
|---------------------------------|--|-----|
| Signal name                     | Description<br>(Status, when the LED is lit) | LED |
| CASDIR                          | Cassette movement direction<br>(left)        | 1   |
| CASENA                          | Cassette movement enable                     | 2   |
| ROTDIR                          | Rotational movement direction<br>(CW)        | 3   |
| ROTENA                          | Rotational movement enable                   | 4   |
| CEPHDIR                         | Ceph movement direction (right)              | 5   |
| CEPHENA                         | Ceph movement enable                         | 6   |
| LINDIR                          | Linear movement direction<br>(toward pillar) | 7   |
| LINENA                          | Linear movement enable                       | 8   |

| <b>Sr 74 IOC, page 1H</b> |  |     |
|---------------------------|--|-----|
| Signal name               | Description<br>(Status, when the LED is lit) | LED |
| PPOWER                    | Panoramic camera power enable                | 1   |
| PIMAGE                    | Panoramic camera image enable                | 2   |
| CPOWER                    | Cephalostat camera power enable              | 3   |
| CIMAGE                    | Cephalostat camera image enable              | 4   |
| CLASLIT                   | Ceph laser light                             | 7   |





| <b>Sr 74 IOC, page 2L</b> |   |     |
|---------------------------|---|-----|
| Signal name               | Description<br>(Status, when the LED is lit)          | LED |
| EXPSW                     | Exposure switch, remote or ctrl. panel                | 1   |
| INSTRUSW                  | Factory mode jumper, digital I/O board X14            | 2   |
| MAOK                      | Tube current monitoring                               | 3   |
| PNLEXPSW                  | Exposure switch on control panel, also triggers EXPSW | 4   |
| EXHSW                     | Exhibition mode jumper, Digital I/O board X11         | 5   |
| MAINS                     | Mains voltage selection (110 v)                       | 7   |



| <b>Sr 74 IOC, page 2H</b> |   |     |
|---------------------------|---|-----|
| Signal name               | Description<br>(Status, when the LED is lit)                  | LED |
| PANCASSW                  | Panoramic cassette inserted / Autocollimator in slot          | 2   |
| CASLIMSW                  | Cassette limit switch / head support vertical position (down) | 3   |
| CASMIDSW                  | Cassette middle switch / Autocollimator presence detection    | 4   |
| LINMIDSW                  | Linear movement middle switch                                 | 5   |

| Sr 74 IOC, page 2H |  |   |
|--------------------|--|---|
| LINLIMSW           | Linear movement limit switch                                   | 6 |
| RACKMIDSW          | Cassette rack middle switch / Autocollimator Cu filter ON, S61 | 7 |
| RACKLIMSW          | Cassette rack limit switch / Autocollimator Cu filter OFF, S62 | 8 |

| Sr 74 IOC, page 3L |  |     |
|--------------------|--|-----|
| Signal name        | Description<br>(Status, when the LED is lit) | LED |
| WD                 | CPU Watchdog timer                           | 5   |

| Sr 74 IOC, page 3H |  |     |
|--------------------|--|-----|
| Signal name        | Description<br>(Status, when the LED is lit) | LED |
|                    | No external signals                          |     |

| Sr 74 IOC, page 4L |  |   |
|--------------------|--|---|
| Signal name        | Description<br>(Status, when the LED is lit) | LED   |
| HOME(RIGHT)        | Patient positioning button, right side       | 1  |
| HOME(LEFT)         | Patient positioning button, left side        | 2  |
| PILWARD            | Layer adjustment button, towards pillar      | 3  |
| CENWARD            | Layer adjustment button, center              | 4  |
| PATWARD            | Layer adjustment button, towards patient     | 5  |
| TEMPFAIL           | Tubehead overheated                          | 6   |
| STOPSW             | Emergency stop switch                        | 7   |

| Sr 74 IOC, page 4H |  |   |
|--------------------|--|---|
| Signal name        | Description<br>(Status, when the LED is lit)                             | LED   |
| COL1SW             | Collimator position signal 1   | 1   |
| COL2SW             | Collimator position signal 2   | 2   |
| COL3SW             | Collimator position signal 3   | 3   |
| SIDE               | Start position button side detection (left)                              | 4   |
| START              | Start position button trigger, activated by either start position button | 5   |
| PROJTRIG           | Positioning lights button  | 6    |
| ZDOWN              | Vertical movement down button  | 7    |
| ZUP                | Vertical movement up button  | 8  |

| Sr 74 IOC, page 5L |  |   |
|--------------------|--|---|
| Signal name        | Description<br>(Status, when the LED is lit)               | LED   |
| CEPHLOK            | Ceph cassette detection / Beam alignment board left sensor | 1   |
| CEPHCOK            | Beam alignment board mid sensor                            | 2   |
| CEPHROK            | Beam alignment board right sensor                          | 3   |
| LAT/PA             | Earholder position detection (P/A)                         | 4   |
| CEPHL              | Ceph at left side<br>(Digital I/O board jumper X15: L)     | 5   |
| CEPHR              | Ceph at right side<br>(Digital I/O board jumper X15: R)    | 6   |
| CEPHDOWN           | Vertical movement up button on cephalostat                 | 7  |

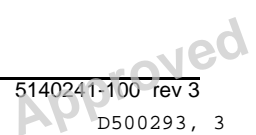

| Sr 74 IOC, page 5L |  |   |
|--------------------|--|---|
| CEPHUP             | Vertical movement down button on cephalostat | 8  |

| Sr 74 IOC, page 5H |   |     |
|--------------------|---|-----|
| Signal name        | Description<br>(Status, when the LED is lit)  | LED |
| ROT1SW             | Rotational movement switch 1<br>(see fig 2.1) | 1   |
| ROT2SW             | Rotational movement switch 2<br>(see fig 2.1) | 2   |
| ROT3SW             | Rotational movement switch 3<br>(see fig 2.1) | 3   |
| ROT4SW             | Rotational movement switch 4<br>(see fig 2.1) | 4   |
| ZMIDSW             | Vertical movement mid switch                  | 5   |
| ZLIMSW             | Vertical movement limit switch                | 6   |
| CEPHMIDSW          | Cephalostat middle switch                     | 7   |
| CEPHLIMSW          | Cephalostat limit switch                      | 8   |

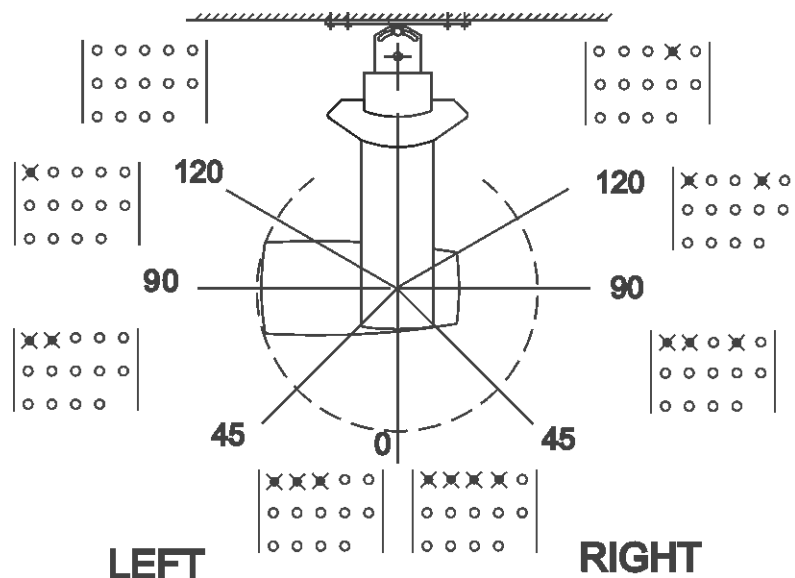

Fig 2.1. Led procedures concerning movement of the rotating unit.

| Sr 74 IOC, page 6L and 6H |  |     |
|---------------------------|--|-----|
| Signal name               | Description<br>(Status, when the LED is lit) | LED |
|                           | No external signals                          |     |

## 2.5 Sr 76 PUP: X-ray tube warm-up

**WARNING!** *Generates x-rays!*

To facilitate testing of a defective tubehead assembly and making a new tubehead, or one that has not been used for a long time, ready for normal use.

**NOTE!** *OP200, that has not been used for three months or more, should be warmed up using this program. Always run this program after replacing the tubehead assembly.*

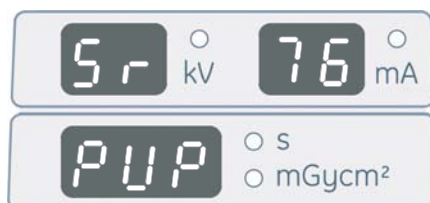

Usage:

1. Select **Sr 76 PUP**.
2. Make an exposure.  
OP200 exposes with the lowest kV / mA values.
3. The exposure values automatically rise to the next kV / mA level (see the table below). Keep making exposures until the highest values are reached or until FAIL is displayed on the kV and mA display.

A FAIL message indicates that arcing and/or breakdown has occurred in the tubehead. Restart the test by pressing the OK button twice. If the FAIL message occurs repeatedly, check *OP200 Troubleshooting Manual*, chapter **Sy 22 Arc** for further instructions.

| Sr 76 PUP: kV & mA Feedback Reference Voltages |      |     |          |          |
|--|------|-----|----------|----------|
| kV   | mA   | s   | (VkVref) | (VmAref) |
| 20   | 1.0  | 3.2 | (1.00 V) | (0.24 V) |
| 30   | 1.0  | 3.2 | (1.50 V) | (0.24 V) |
| 40   | 1.0  | 3.2 | (2.00 V) | (0.24 V) |
| 50   | 1.0  | 3.2 | (2.50 V) | (0.24 V) |
| 54   | 1.0  | 3.2 | (2.70 V) | (0.24 V) |
| 57   | 1.0  | 3.2 | (2.85 V) | (0.24 V) |
| 60   | 1.0  | 3.2 | (3.00 V) | (0.24 V) |
| 63   | 1.0  | 3.2 | (3.15 V) | (0.24 V) |
| 66   | 1.0  | 3.2 | (3.30 V) | (0.24 V) |
| 70   | 1.0  | 3.2 | (3.50 V) | (0.24 V) |
| 73   | 1.0  | 3.2 | (3.65 V) | (0.24 V) |
| 77   | 1.0  | 3.2 | (3.85 V) | (0.24 V) |
| 81   | 1.0  | 3.2 | (4.05 V) | (0.24 V) |
| 85   | 1.0  | 3.2 | (4.25 V) | (0.24 V) |
| 85   | 2.0  | 3.2 | (4.25 V) | (0.49 V) |
| 85   | 2.5  | 3.2 | (4.25 V) | (0.61 V) |
| 85   | 3.2  | 3.2 | (4.25 V) | (0.78 V) |
| 85   | 4.0  | 3.2 | (4.25 V) | (0.97 V) |
| 85   | 5.0  | 3.2 | (4.25 V) | (1.22 V) |
| 85   | 6.4  | 3.2 | (4.25 V) | (1.56 V) |
| 85   | 8.0  | 3.2 | (4.25 V) | (1.94 V) |
| 85   | 10.0 | 3.2 | (4.25 V) | (2.43 V) |
| 85   | 12.0 | 3.2 | (4.25 V) | (2.92 V) |



4. Press OK to exit the program.
5. Switch the unit off and on again to reset it to normal operating mode.
6. Ensure proper operation by making a panoramic exposure (P1) using maximum exposure values.

## 2.6 Sr 77 Prh: Adjust the preheat setting

**WARNING!** *Generates X-rays!*

To make the unit adjust its filament preheat level. The adjustment is done automatically, you only need to press the exposure button.



Usage:

1. Select **Sr 77 Prh**. The exposure values that are used during the exposure are shown on the kV and mA displays. The current preheat reference is shown on the time/dose display.
2. Press and hold the exposure button. OP200 starts increasing the preheat reference, continuously monitoring the mA feedback from the filament. The current reference value is shown on the time/dose display.
3. When a proper mA feedback value is received from the filament, the preheat reference feedback reference is locked and the exposure is terminated. The final preheat reference value (between 50 and 60) is displayed on the time/dose display. If correct mA feedback was not reached during the exposure, the previous preheat reference is displayed.
4. Press OK to exit the program.



## 2.7 Sr 78 thA: Set Dose Calibration Constant (DCC)

For setting the Dose Calibration Constant (DCC). The unit needs this constant to be able to calculate the dose correctly. If the calibration constant is missing, a Ch 12 dCC failure code is shown when the unit is switched on.



Set the dose calibration constant according to the dose rate of the tubehead, which is measured as part of the manufacturing process of the unit. The measured value is recorded on a label on the back of the tubehead. Enter the value in steps on 0.1 R/min in the range 6.5-30 R/min.

Since this value is supposed to change only when the tubehead is exchanged, the preheat offset (see Pr 77 Prh) and tubehead specific counter are set to 0 when a new dose calibration constant is entered.

Usage:

1. Select **Sr 78 thA**. By pressing the left and right buttons the kV display shows cncL (stands for "cancel") or t100.
2. To exit without making changes, press OK.
3. To edit the calibration constant for the current tubehead, select t100 by pressing the right button once. Move down to the calibration constant value shown in the time/dose display by pressing the down button once. Use the left and right button to modify the value.
4. To store the new dose calibration constant and exit the program, press OK. To cancel any changes, select cncL by first pressing the up button and thereafter the left button.
5. Press OK to exit the program.

## 2.8 Sr 79 SUP: Display line voltage

To view power supply line voltage as seen by OP200. Used both for checking if the line voltage is sufficient for the unit to operate correctly, and troubleshooting problems related to the voltage level (e.g. sporadic Ch 5 failures). The line voltage is derived from a +25V supply in the Filament Control Board. Thus if the +25V voltage is absent, for example due to the emergency stop button being depressed, the voltage is not correctly displayed.



The accuracy of the voltage display is  $\pm 5\%$ .

Usage:

1. Select **Sr 79 SUP**. The time/dose display shows the approximate line voltage value.



2. Press OK to exit the program.

## 2.9 Sr 80 CrL: Test motor movement

Lets you test individual movements for proper operation.

The movement type currently selected is shown in the kV field. In film units, the available tests are cassette (CA), cephalostat (CE), rotation (RO) and linear (LI). For digital units these are: automatic collimator (Co), cephalostat (CE), rotation (RO) and linear (LI). Only relevant tests are accessible, i.e. CE and Co are not shown if the corresponding options are not installed.

The mA field shows the number of accelerations to be done in one test. The number is settable in the range 0-4 for the collimator test (Co), and 1-5 for the others. Setting the value to 0 in the collimator test means that only the copper filter is moved.

The speed ratio to be used is shown in the time/dose display. If the ratio is set to 1.00, the movements are done using nominal speed (the speed most typically used) of the movement in question. Setting it to e.g. 0.50 means the movement is done at 50% of the nominal speed.

Some movements can be done with or without exposure. In test mode (T) the test is made without X-rays. In manual mode (M), a static exposure is active. Edit the exposure values in the kV and mA fields.



Usage:

1. Select **Sr 80 CrL**. The current movement type is shown on the kV display, the number of accelerations on the mA display and the speed ratio on the time/dose display.
2. Move between the fields using the up and down buttons, and change the settings using the left and right buttons. Test by pressing the exposure button.
3. A FAIL message is shown on the control panel. See *OP200 Trouble Shooting Manual*, chapter **Sy 30 PoC** (ceph), **Sy 28 PoC** (cassette), **Sy 29 PoL** (linear), **Sy 27 Por** (rotation) or **Sr 38 COL** (automatic collimator) according to the current type of movement.
4. If the movement succeeded, the difference between the measured and the expected length of the movement is displayed on the time/dose display (for negative values, the minus sign is shown on the mA display). Write down this value. No value is shown in the Co test.
5. Repeat the test in the other direction by re-pressing the exposure button. Compare the value shown in the time/dose display to the value gained in the other direction. The difference should be kept within the tolerances listed in the table below for the unit to function properly.
6. Press OK to exit the program.

| Motor movement test | Limit values for acceptance |
|---------------------|-----------------------------|
| CA (cassette)       | ± 1.0 mm                    |
| CE (cephalostat)    | ± 1.0 mm                    |
| ro (rotation)       | ± 2.0°                      |
| li (linear)         | ± 1.2 mm                    |

## 2.10 Sr 81 bPL: Display biteplate properties (Volumetric Tomography option only)

For checking the electrical operation of the Volumetric Tomography patient positioning and calibration devices. Two analog signals are used with these devices; one senses the device type, and the other the position of the device. The signals are named DEV and POS on OP200 wiring diagram. The information is shown on the control panel as follows:



- The kV display shows the currently selected side when the projection biteplate is attached. The side and region are also indicated by the section display.

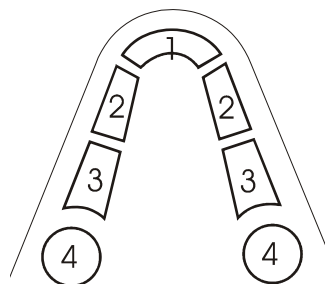

### Sections

1. Anterior
2. Premolar
3. Molar
4. Jaw joint (not in use)

- The mA display shows the type of the device.
- The time and dose indicator LEDs indicate the currently selected signal (s for POS and mGycm<sup>2</sup> for DEV). The signal level of the selected channel is shown in the time/dose display.

| POS (only valid for projection bite plate) |              |            |
|--|--------------|------------|
| Voltage                                    | Position     | kV display |
| 0,65 +/- 0,2V                              | Left Molar   | LE         |
| 1,4 +/- 0,2V                               | Left Canine  | LE         |
| 2,02 +/- 0,2V                              | Incisor      | --         |
| 2,73 +/- 0,2V                              | Right Canine | ri         |
| 3,44 +/- 0,2V                              | Right Molar  | ri         |

| DEV            |             |            |
|----------------|-------------|------------|
| Voltage        | Device      | mA display |
| 1,35 +/- 0,25V | Panorama    | PA         |
| 1,8 +/- 0,25V  | Calibration | CA         |
| 2,7 +/- 0,25V  | Projection  | Pr         |

Usage:

1. Select **Sr 81 bPL**.
2. Press the left / right button to view the voltage level for POS or DEV.
3. Insert different patient positioning devices and/or turn the positioning device into different positions. Verify that the displayed values match the ones listed above.
4. Press OK to exit the program.



## 2.11 Sr 82 COL: Set/display collimator information

**In digital units:** displays collimator information, which cannot be edited.

- The kV and mA displays show the type of collimator. "Std" stands for standard (manual) and "Auto" for automatic collimator.
- With automatic collimator, also some related signals are shown.
  - The signals PANCASSW, COL1SW, COL2SW and COL3SW are shown as P1 - P4. These LEDs directly match LED H2-H5 on the collimator board.
  - The states of the copper filter switches are shown as LED P5 (filter used) and P6 (filter not used).
  - Collimator position is shown in the time display. The position ranges from 0 to 10, uneven numbers being the in-slot positions.

Usage:

1. Select **Sr 82 COL**.
2. Use the information displayed for e.g. troubleshooting purposes.
3. Press OK to exit the program.



**In film units:** To select the type of collimator aperture installed in each of the configurable slots. The slots are numbered 1-3 in the program. Slot number one is the one closest to the panorama slot, number two is in the middle, and three farthest away from the panorama slot. The information to be entered in the program is engraved in the collimator plate.

**NOTE!** Available in digital units starting from software version R2.4



Usage:

1. Select **Sr 82 COL**.
2. Select the slot to be edited using the up / down arrows. The current slot is shown blinking in the time/dose display a few seconds after the slot has changed.
3. Select the correct aperture type for the current slot using the left / right buttons. The aperture size is shown in the kV and mA display. Additional information such as is the aperture is of type left (L), right (r) or symmetrical (S) is shown in the time/dose display. For horizontal apertures, an additional "H" is displayed in the time/dose display. Unconfigured or empty collimator slots are shown as "----".

Example: The installed collimator is named "18X24AH". The kV display shows "18" and the mA display shows "24". The time display shows "rH" or "LH", depending on whether the collimator is of type "LEFT" or "RIGHT"

**NOTE!** Configuration of the first slot is not possible if OrthoTrans is enabled. This slot is shown as "ortr".



4. Press OK to exit the program.

## 2.12 Sr 86 Sto: Store settings

To store the current configuration for future use as default values. The program affects the configuration into which the system is restored using the program Pr 53 nor. The stored values are listed as follows.

| Configuration item         | Set by user program  |
|----------------------------|----------------------|
| Default procedure and mode | Pr 51 PUS            |
| Contrast levels            | Pr 52 pCo, Pr 52 gCo |
| Ortho Trans settings       | Pr 50 Lay            |
| VT settings                | Pr 50 S3d            |
| Beeper settings            | Pr 60 bEP            |
| Dose display options       | Pr 65 doS            |
| Horizontal cephal limit    | Pr 63 CEL            |

Usage:

1. Select **Sr 86 Sto**.
2. To store the settings when the program is exited, select "on" by pressing the right button. To cancel storing the values, select "OFF" by pressing the left button.
3. Press OK to exit the program.

## 2.13 Sr 87 LAL: Set linear adjustment value for VT

**NOTE!** See *Volumetric Tomography® Option Installation & Adjustments Manual*.

For adjusting the linear position of the imaging layer in VT imaging programs.



Usage:

1. With **Sr 92 Che** set to **nBp**, take a VT panoramic image of the pin-ball phantom.
2. Select **Sr 87 LAL**. The current adjustment value is shown on the time/dose display.

3. Use the left/right buttons to enter the width of the ball in the kV field. Move the flashing light to the mA field using the down button. Enter the height of the ball using the left/right buttons. The program calculates a new linear adjustment value and displays it on the time/dose display.
4. Press OK to exit the program.
5. Take a new VT panorama image of the ball-pin phantom. If the ball is still not round (within a tolerance of 0.1 mm), repeat steps 2-5 using the height/width value from the newly taken image.

The adjustment value can also be edited manually. This can be done for example if the correct value is known in advance. To edit the value manually, move the flashing light to the time/dose display. Modify the value using the left/right buttons.

**NOTE!** *The linear adjustment value is not changed if height or width is not entered, or if height and width are set equal (for example height=6.0, width=6.0).*

## 2.14 Sr 88 CAL: Disable automatic cephalostat alignment correction (digital units only)

Lets you disable automatic adjustment of the cephalostatic beam during exposure. Automatic adjustment should be enabled to allow the unit to compensate for small beam alignment errors, but may be temporarily disabled for troubleshooting purposes.

Usage:

1. Select **Sr 88 CAL**. The current setting is displayed on the time/dose display. The value **on** means that automatic adjustment is enabled (normal usage) while **OFF** means that it's disabled (troubleshooting).
2. Using the left and right buttons, disable or enable automatic adjustment as appropriate.
3. Press OK to exit the program.



## 2.15 Sr 88 CAL: Set cephalostat alignment value (film units only)

To align the THA with the cephalostat. The adjustment value set here affects the rotational angle of the THA, and thereby the horizontal position of the x-ray beam on the film. A positive adjustment value moves the beam to the right and vice versa. The value is shown in centimeters.



Usage:

1. Select **Sr 88 CAL**. The current adjustment value is shown on the time/dose display.
2. Using the left and right buttons, modify the adjustment value as appropriate.
3. Press OK to exit the program.

## 2.16 Sr 89 COP: Set country options

Lets you customize the unit according to regional regulations and user expectations.

Lists a number of options, each having a number (shown in the kV field) and a short name (shown in the mA field). The value associated with the option is shown in the time/dose field. The options available are described below.



| Sr 89 COP: COUNTRY OPTIONS |       |   |
|----------------------------|-------|---|
| Option                     | Value | Description   |
| 1<br>rE                    | OFF   | Exposure is possible with both control panel and remote exposure button.  |
|                            | on    | Exposure is possible only with the remote exposure button in AEC and Manual mode. In the test mode exposure is possible from both remote exposure button and control panel. |
| 2<br>C1<br>(Film only)     | OFF   | Image size 24x30 cm is allowed.   |
|                            | on    | Image size 24x30 is prohibited. Initiating an exposure with the 24x30 collimator results in a collimator error.   |
| 3<br>nA                    | OFF   | AEC is available in normal operating mode.  |
|                            | on    | AEC is disabled; OP200 can be used without AEC Board (useful in eg. OP200 CR models missing this feature).  |
| 4<br>FE                    | OFF   | Exposure values are selected in steps as combinations of kV/mA/s. The difference in radiation output between each step is constant.   |
|                            | on    | "Free selection" is enabled. Exposure values (kV/mA/s) can be selected independently of each other.   |
| 5<br>Er                    | OFF   | Error messages are not sent to the Ortho ID device.   |
|                            | on    | Error messages are sent to the Ortho ID.  |
| 6<br>P6                    | OFF   | The Lateral TMJ imaging program is used as imaging program P6.  |
|                            | on    | The Ortho (axially corrected) Lateral TMJ imaging program is used as imaging program P6.  |
| 7<br>Or<br>(FILM ONLY)     | OFF   | Ortho Trans is disabled.  |
|                            | on    | Ortho Trans is enabled.   |

| Sr 89 COP: COUNTRY OPTIONS |     |  |
|----------------------------|-----|--|
| 8<br>3d<br>(DIGITAL ONLY)  | OFF | Volumetric Tomography is disabled.   |
|                            | on  | Volumetric Tomography is enabled.<br><br><b>NOTE!</b> <i>Setting the 3D option on resets the VT exposure values to their default values.</i>                 |
| 9<br>qA                    | OFF | Quality assurance images consist of 15 exposed areas using different kV/mA values.   |
|                            | on  | Quality assurance images are taken of special test objects in accordance with IEC 61223-3-4 (digital units only).  |
| 10<br>C2                   | OFF | Only normal panoramic collimator is allowed in P1, P3-P5. Only pediatric (height limited) collimator is allowed in P2.                                       |
|                            | on  | Normal and pediatric (height limited) collimator can be used interchangeably in P1-P5.   |
| 12<br>SE                   | OFF | Section selection disabled.  |
|                            | on  | Section selection enabled. Imaging can be restricted to certain regions of interest, reducing dose and imaging time (not available in all imaging programs). |

## Usage:

1. Select **Sr 89 COP**. One of the options is displayed.
2. Select the desired option using the up and down buttons.
3. Change the option's value to **OFF** by pressing the left button or **on** by pressing the right button.
4. Press OK to exit the program.



## 2.17 Sr 90 PIN: Panorama installation program

**NOTE!** See *OP200 installation manual*.

**WARNING!** Generates x-rays!

For taking exposures without movements and can be used for troubleshooting and calibration. When this program is used, the KVOK and MAOK signals are not monitored. Therefore error codes **Sy 23 Inu** and **Sy 24 FIL** are not enabled.

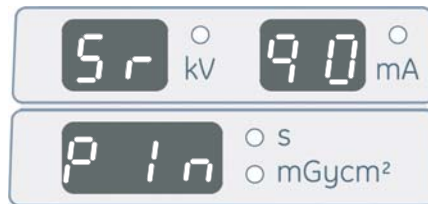

Usage:

1. Select **Sr 90 Pin**.
2. Press the up and down button to get the A (automatic mode), M (manual mode) or T (test mode) indicator light blinking. Select mode using the left and right buttons.
3.
  - **Automatic collimator** (selection only possible in Manual mode): Select collimator using the left and right buttons.
  - **Manual collimator:** Move the collimator as appropriate. In AEC mode use the standard panoramic collimator.
4. Select exposure values by pressing the up and down buttons to select the desired field and left and right buttons to edit the value. No exposure values can be entered in Test mode.
5. Prepare the unit for exposure. In Manual mode, attach the fluorescent tool or enable imaging on the PC. In AEC mode, attach the calibration tool to the tubehead.
6. Press the exposure switch to start the exposure. In AEC and Test mode the AEC frequency is displayed in the time/dose field.
7. Make adjustments and repeat steps 1-7 if needed.
8. Press OK to exit the program.



## 2.18 Sr 91 CIN: Cephalostat installation program (digital units only)

For alignment adjustment of the cephalostat.

**NOTE!** *The cephalostat alignment of film based units is performed in normal operating mode. See OP200 Installation Manual.*



The program has three modes of operation:

- Automatic mode (A) produces an adjustment image by keeping the x-ray beam still while the cephalostat camera and secondary collimator are driven from a position 5 cm before the beam center to 5 cm after it.
- Manual mode (M) performs an exposure without movements. The resulting image can be used for adjusting the collimator's alignment.
- Test mode (T) positions the unit for exposures in Manual mode. Set an adjustment value affecting the x-ray beam's horizontal position in the time/dose field. A positive value moves the x-ray beam to the right and vice versa. The value is given in centimeters.

Usage:

1. Select **Sr 91 Cin**.
2. Press the up and down button until one of the A, M or T indicator lights is blinking. Select mode using the left and right buttons.
3. **Automatic collimator:** In mode M: select normal or pediatric type collimator by pressing the up button until the pediatric collimation indicator light is blinking. Press the left button to use the standard height collimator (indicated as LED 9a or 9b being lit).
4. Select exposure values by pressing the up/down buttons to select the desired field and left/right buttons to edit the value. Only the adjustment value can be edited in Test mode.

5. Make the system ready for image capturing (modes A and M).
6. Press the exposure button to make an exposure (modes A and M) or position the unit (mode T).
7. Make adjustments and repeat steps 1-7 if needed.
8. Press OK to exit the program.

## 2.19 Sr 92 CHE: Set level of self-checks

For temporarily disabling checks and operations that normally are performed before exposure is started.



**WARNING!** *The checks may only be disabled while the unit is operated by service personnel, and only for the purpose of installation and maintenance. Make sure to power cycle the unit before handling it over to the user!*

The checks/operations are divided into different levels. The table below outlines which checks are disabled on each level. Some of the levels are only available in digital / film based units.

| Level | Disabled check or operation |  |          |           |                  |
|-------|-----------------------------|--|----------|-----------|------------------|
|       | PC link                     | Collimator, Earholder, Ceph beam alignment <sup>1)</sup> | Cassette | Biteplate | Radiation output |
| OFF   |                             |  |          |           |                  |
| nPC   | ■                           |  |          |           |                  |
| nCO   |                             | ■  |          |           |                  |
| nCA   |                             |  | ■        |           |                  |
| nbP   |                             |  |          | ■         |                  |
| nCh   | ■                           | ■  | ■        | ■         |                  |
| nra   |                             |  |          |           | ■                |
| non   | ■                           | ■  | ■        | ■         | ■                |

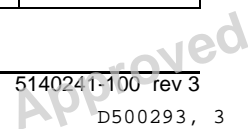

1) With manual collimator, collimator type checking is disabled. With automatic collimator, this level disables driving at the collimator and earholder position checking.

Usage:

1. Select **Sr 92 Che**.
2. Using the left and right button, select the desired level. Select OFF to enable all checks and operations.
3. Press OK to exit the program. Checking is set to the selected level.

## 2.20 Sr 93 BAL: Adjust beam alignment board sensitivity

**NOTE!** See the *OP200 installation manual*.

For adjusting the sensitivity of the sensors on the beam alignment board. It assists in driving the cephalostat camera and secondary collimator into the correct position and selecting appropriate exposure values.

This program has two modes of operation:

- Test mode positions the unit according to the currently selected channel.
- Manual mode performs an exposure without movements.

The AEC density LEDs indicate the currently selected channel. The midmost LED corresponds to the mid channel on the Beam alignment board.

In units equipped with automatic collimator, the selected collimator type (normal height / pediatric) is indicated by the pediatric collimation LED.

Usage:

1. Select **Sr 93 BAL**.
2. Select the channel to be adjusted by pressing the up / down buttons until one of the AEC density LEDs is blinking. Change channel by pressing the left / right buttons.
3. Select correct collimator.

**Manual collimator:** Move the cephalometric collimator into position. Use copper filtration as appropriate for the channel.

**Automatic collimator:** Press the up button until the pediatric collimation LED is blinking. Press the left button to use normal height collimation or right to use pediatric collimation.

4. Select Test mode. Press the exposure button to drive the unit into position for exposure.
5. Select Manual mode. Press the exposure button to make an exposure. The AEC density LEDs reflect the channel levels during exposure.
6. Adjust the channel so that it's barely triggered during exposure (the corresponding LED is lit). Repeat steps 2 to 6 for all channels.
7. Press OK to exit the program.

Approved





Instrumentarium Dental reserves the right to make changes in specification and features shown herein, or discontinue the product described at any time without notice or obligation. Contact your Instrumentarium Dental representative for the most current information.

Copyright © 05/2008 by PaloDEX Group Oy. All rights reserved.

Instrumentarium Dental  
Nahkelantie 160, FI-04300 Tuusula, Finland  
Tel. +358 45 7882 2000  
Fax +358 9 851 4048

Americas:  
Instrumentarium Dental Inc.  
Milwaukee, Wisconsin, U.S.A.  
Tel. 800 558 6120  
Fax 414 481 8665



Approved